

---

<b>General Description</b>	pg. H2
----------------------------	--------

---

<b>Visual Index</b>	pg. H3
---------------------	--------

---

<b>Ball Valves</b>	
Wide range of brass, carbon steel and stainless steel ball valves. For use as fuel shut-off lines and other general purpose applications that require shut-off capability.	
<b>Note:</b> Please refer to Catalog 3501-E for special working pressures and other technical data.	pg. H5

---

<b>Drain and Ground Plug Shutoff Cocks</b>	
System temperature and the type of tubing should be considered. Ground plug shutoffs are designed to withstand 30 psi working pressure. Drain cocks are designed to withstand up to 150 psi working pressure, unless otherwise noted.	pg. H18

---











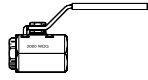
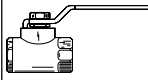
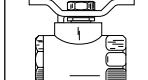
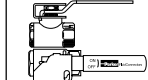

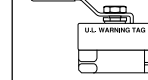
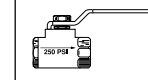
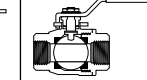

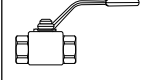
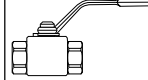
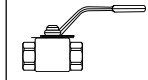
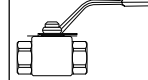
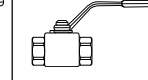
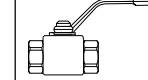
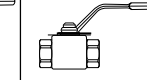













<b>Lanyard Valves</b>	
For use with low pressure air systems such as air tanks on heavy trucks. Brass construction with specially formulated low temperature seal which remains elastic to temperatures as low as -40°F. Working Pressures up to 150 psi, Temperature Ranges -40°F to +200°F.	pg. H17

---







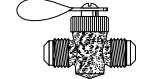

<b>Needle &amp; Truck</b>	
Up to 150 psi working pressure, unless otherwise noted.	pg. H13

**Note:** Please refer to Catalog 3501-E for further information.

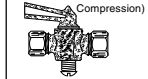
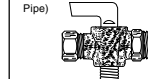
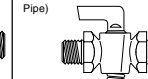
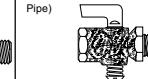
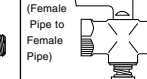
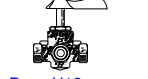
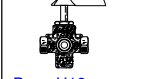
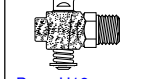
## Brass Valves/Ball

<p><b>V500CS</b> Carbon Steel Ball Valve</p>  <p>Page H5</p>	<p><b>V500P</b> Brass Ball Valve</p>  <p>Page H5</p>	<p><b>V500P-04</b> T Handle Brass Ball Valve</p>  <p>Page H5</p>	<p><b>VP500P</b> Locking Handle Brass Ball Valve</p>  <p>Page H5</p>	<p><b>XV500P</b> Bronze Ball Valve</p>  <p>Page H5</p>	<p><b>V500PUL</b> UL Ball Valve</p>  <p>Page H6</p>	<p><b>VV500P</b> Vented Ball Valve</p>  <p>Page H6</p>	<p><b>V500SS</b> Stainless Steel Ball Valve</p>  <p>Page H6</p>
<p><b>V501P</b> Male/Female Ball Valve</p>  <p>Page H6</p>	<p><b>V500HP</b> Female-Female Pipe Ends</p>  <p>Page H6</p>	<p><b>V500HP (LARGE)</b> Female-Female Pipe Ends</p>  <p>Page H6</p>	<p><b>VP500HP</b> Locking-Female- Female Pipe Ends</p>  <p>Page H7</p>	<p><b>VP500HP (LARGE)</b> Locking-Female- Female Pipe Ends</p>  <p>Page H7</p>	<p><b>V506HP</b> Female-Female Pipe Ends</p>  <p>Page H7</p>	<p><b>V506HP (LARGE)</b> Female-Female Pipe Ends</p>  <p>Page H7</p>	<p><b>VP506HP</b> Locking-Female- Female Pipe Ends</p>  <p>Page H8</p>
<p><b>VP506HP (LARGE)</b> Locking-Female- Female Pipe Ends</p>  <p>Page H8</p>	<p><b>V510P</b> Male-Female Straight Thread O-Ring Port</p>  <p>Page H8</p>	<p><b>VV510P</b> Vented, Straight Thread O-Ring Port</p>  <p>Page H8</p>	<p><b>VP510P</b> Locking Handle Straight Thread O-Ring Port</p>  <p>Page H9</p>	<p><b>VVP510P</b> Locking Handle Male-Female Straight Thread O-Ring Port</p>  <p>Page H9</p>	<p><b>V510P-X-04</b> Tee Handle Straight Thread O-Ring Port</p>  <p>Page H9</p>	<p><b>V510P-X-21</b> Oval Handle Straight Thread O-Ring Port</p>  <p>Page H9</p>	<p><b>V520P</b> Brass Ball Valve</p>  <p>Page H9</p>
<p><b>V590P</b> 90° Flow Male- Female Pipe Ends</p>  <p>Page H10</p>	<p><b>V590P-X-04</b> Lever Handle 90° Flow Male- Female Pipe Ends</p>  <p>Page H10</p>	<p><b>V591P</b> 90° Flow Male- Male Pipe Ends</p>  <p>Page H10</p>	<p><b>V591P-X-04</b> Lever Handle 90° Flow Male- Male Pipe Ends</p>  <p>Page H10</p>	<p><b>V500P-HB</b> Brass Hose Barb Ball Valve</p>  <p>Page H10</p>	<p><b>V506P</b> Female-Female Straight Thread O-Ring Port</p>  <p>Page H11</p>	<p><b>V506P-20, -24, -32</b> Female-Female Straight Thread O-Ring Port</p>  <p>Page H11</p>	<p><b>VV501P</b> Vented, Locking Handle Male- Female Pipe Ends</p>  <p>Page H11</p>
<p><b>V501P-X-04</b> Tee Handle Male- Female Pipe Ends</p>  <p>Page H11</p>	<p><b>V501P-X-21</b> Oval Handle Male- Female Pipe Ends</p>  <p>Page H11</p>	<p><b>V502P</b> Female-Female Pipe Ends Panel Mount</p>  <p>Page H12</p>	<p><b>VV502P</b> Vented Female- Female Pipe Ends Panel Mount</p>  <p>Page H12</p>	<p><b>VP502P</b> Locking Handle Female Pipe Ends Panel Mount</p>  <p>Page H12</p>	<p><b>VVP502P</b> Vented Locking Handle Female Pipe Ends Panel Mount</p>  <p>Page H12</p>	<p><b>V502P-X-04</b> Tee Handle Female Pipe Ends Panel Mount</p>  <p>Page H13</p>	<p><b>V502P-X-21</b> Oval Handle Female Pipe Ends Panel Mount</p>  <p>Page H13</p>







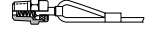













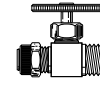

## Brass Valves/Drain and Ground Plug Shutoff

<p><b>V201F</b> Brass Shutoff Cock (Flare to Flare)</p>  <p>Page H17</p>	<p><b>V203F</b> Ground Plug Shutoff Cock (Flare to Flare)</p>  <p>Page H17</p>	<p><b>V204F</b> Ground Plug Shutoff Cock (Flare to Male Pipe)</p>  <p>Page H17</p>	<p><b>V303C</b> Ground Plug Shutoff Cock (Compression to Compression)</p>  <p>Page H17</p>	<p><b>V304C</b> Ground Plug Shutoff Cock (Compression to Male Pipe)</p>  <p>Page H18</p>	<p><b>V401P</b> Ground Plug Shutoff Cock (Male Pipe to Male Pipe)</p>  <p>Page H18</p>	<p><b>V402P</b> Ground Plug Shutoff Cock (Female Pipe to Male Pipe)</p>  <p>Page H18</p>	<p><b>V403P</b> Ground Plug Shutoff Cock (Female Pipe to Female Pipe)</p>  <p>Page H18</p>
<p><b>V406P</b> Three-Way Valve (Female Pipe 3 Ends)</p>  <p>Page H18</p>	<p><b>V407P</b> Four-Way Valve (Female Pipe 4 Ends)</p>  <p>Page H18</p>	<p><b>DC601</b> Drain Cock</p>  <p>Page H19</p>	<p><b>DCR601</b> Drain Cock</p>  <p>Page H19</p>	<p><b>DC602</b> Internal Seat Drain Cock</p>  <p>Page H19</p>	<p><b>DC603</b> Drain Cock</p>  <p>Page H19</p>	<p><b>DC606</b> External Seat Drain Cock</p>  <p>Page H19</p>	<p><b>DC607</b> Bib Drain Cock</p>  <p>Page H19</p>

## Brass Valves/Lanyard Valves

<p><b>LV91</b> Lanyard Valve</p>  <p>Page H17</p>							
--	--	--	--	--	--	--	--

# Brass Valves/Needle, Truck

<p><b>HV104C-Kit</b> Humidifier Valve Clamp Kit</p>  <p>Page H13</p>	<p><b>SPV104C-Kit</b> Self-piercing humidifier valve clamp kit</p>  <p>Page H13</p>	<p><b>NV104C</b> Angle-Needle Valve (Compression to Male Pipe)</p>  <p>Page H13</p>	<p><b>NV101F</b> Angle Needle Valve (Flare to Male Pipe)</p>  <p>Page H13</p>	<p><b>NV102F</b> Needle Valve (Flare to Male Pipe)</p>  <p>Page H14</p>	<p><b>NV103F</b> Needle Valve (Flare to Male Pipe)</p>  <p>Page H14</p>	<p><b>HV104C</b> Humidifier Valve (Compression to Male Pipe)</p>  <p>Page H14</p>	<p><b>NV105C</b> Needle Valve (Compres- sion to Compression)</p>  <p>Page H14</p>
<p><b>NV106C</b> Needle Valve (Compres- sion to Male Pipe)</p>  <p>Page H14</p>	<p><b>NV107P</b> Humidifier Valve (Male Pipe to Male Pipe)</p>  <p>Page H14</p>	<p><b>NV108P</b> Needle Valve (Female Pipe to Male Pipe)</p>  <p>Page H15</p>	<p><b>NV109P</b> Needle Valve (Female Pipe to Female Pipe)</p>  <p>Page H15</p>	<p><b>NV311P</b> Needle valve (Poly- Tite to Male Pipe)</p>  <p>Page H15</p>	<p><b>NV312P</b> Angle Needle Valve (Poly-Tite to Male Pipe)</p>  <p>Page H15</p>	<p><b>V404P</b> Truck Valve (Hose to Male Pipe)</p>  <p>Page H15</p>	<p><b>V404PH</b> Truck Valve (Hose to Male Pipe with Pin Handle)</p>  <p>Page H15</p>
<p><b>SV404P</b> Truck Valve (Hose to Male Pipe)</p>  <p>Page H16</p>	<p><b>V405P</b> Truck Valve (Female Pipe to Male Pipe)</p>  <p>Page H16</p>	<p><b>V408NTA</b> Truck Valve (Tube to Male Pipe)</p>  <p>Page H16</p>	<p><b>V409F</b> Truck Valve (Flare to Male Pipe)</p>  <p>Page H16</p>	<p><b>V410NTA</b> Truck Valve (Tube to Male Pipe)</p>  <p>Page H16</p>	<p><b>V412F</b> Truck Valve (Tube to Male Pipe)</p>  <p>Page H16</p>	<p><b>XV590P-8</b> Truck Valve (Female Pipe to Male Pipe)</p>  <p>Page H17</p>	

**Carbon Steel Ball Valve**

**V500CS**

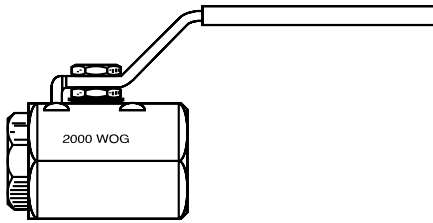

Pipe Thread	Part No.
1/4	V500CS-4
3/8	V500CS-6
1/2	V500CS-8
3/4	V500CS-12
1	V500CS-16

**T Handle Brass Ball Valve**

**V500P-04**

Pipe Thread (PTF)	Part No.
1/4	V500P-4-04
3/8	V500P-6-04
1/2	V500P-8-04
3/4	V500P-12-04
1	V500P-16-04

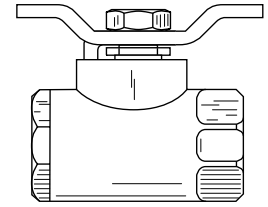

**Locking Handle Brass Ball Valve**

**VP500P**

Pipe Thread (PTF)	Part No.
1/4	VP500P-4
3/8	VP500P-6
1/2	VP500P-8
3/4	VP500P-12
1	VP500P-16

Top

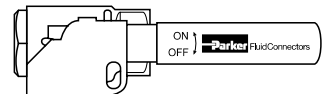

Side

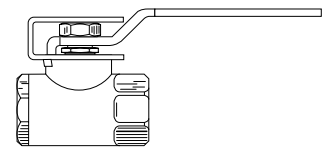

**Brass Ball Valve**

**V500P**

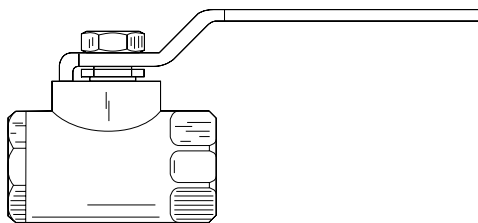

Pipe Thread	Part No.
1/4	V500P-4
3/8	V500P-6
1/2	V500P-8
3/4	V500P-12
1	V500P-16

**UL Ball Valve**

**V500PUL**

Pipe Thread (PTF)	Part No.
1/4	V500PUL-4
3/8	V500PUL-6
1/2	V500PUL-8
3/4	V500PUL-12
1	V500PUL-16

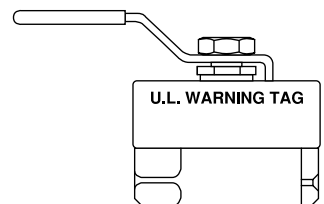

**Bronze Ball Valve**

**V500P**

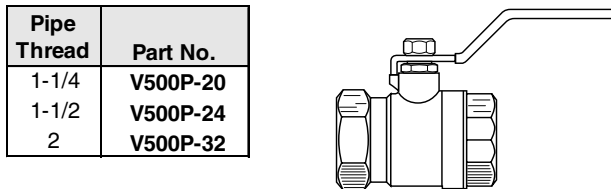

Pipe Thread	Part No.
1-1/4	V500P-20
1-1/2	V500P-24
2	V500P-32

**Vented Ball Valve**

**VV500P**

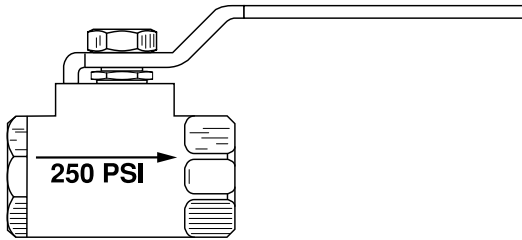

Pipe Thread	Part No.
1/4	VV500P-4
3/8	VV500P-6
1/2	VV500P-8
3/4	VV500P-12
1	VV500P-16

**Stainless Steel Ball Valve**

**V500SS**

Pipe Thread (PTF)	Part No.
1/4	V500SS-4
3/8	V500SS-6
1/2	V500SS-8
3/4	V500SS-12
1	V500SS-16
1-1/4	V500SS-20
1-1/2	V500SS-24
2	V500SS-32

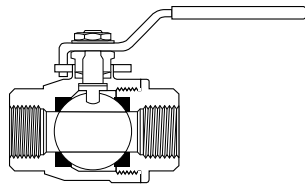

**Male/Female Ball Valve**

**V501P**

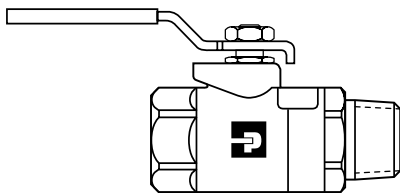

Size	Part No.
1/4	V501P-4
3/8	V501P-6
1/2	V501P-8
5/8	V501P-10
3/4	V501P-12
1	V501P-16

**6000 PSI Female-Female Pipe Ends**

**V500HP**

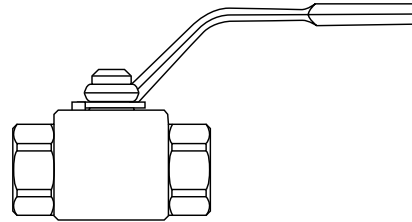

Pipe Thread	Part No.
1/4-18	V500HP-4
3/8-18	V500HP-6
1/2-14	V500HP-8
3/4-14	V500HP-12
1-11.5	V500HP-16

**6000 PSI Female-Female Pipe Ends**

**V500HP (LARGE)**

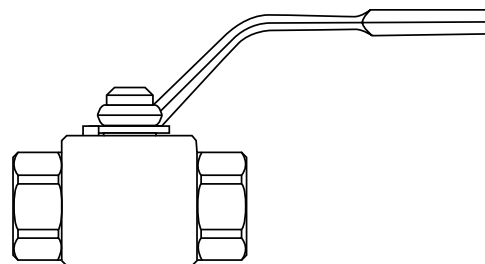

Pipe Thread	Part No.
1 1/4-11.5	VP500HP-20
1 1/2-11.5	VP500HP-24
2-11.5	VP500HP-32

**6000 PSI  
Locking-Female-Female  
Pipe Ends**

**VP500HP**

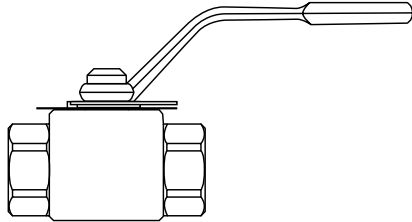

Pipe Thread	Part No.
1/4-18	VP500HP-4
3/8-18	VP500HP-6
1/2-14	VP500HP-8
3/4-14	VP500HP-12
1-11.5	VP500HP-16

**6000 PSI Female-Female  
Pipe Ends**

**V506HP**

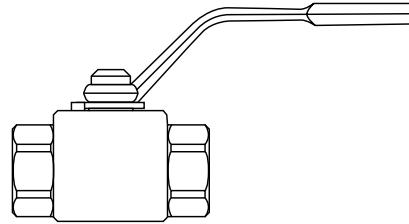

Straight Thread	Part No.
7/16-20 UNF	V506HP-4
9/16-18 UNF	V506HP-6
3/4-16 UNF	V506HP-8
1 1/16-12 UNF	V506HP-12
1 5/16-12 UNF	V506HP-16

**6000 PSI  
Locking-Female-Female  
Pipe Ends**

**VP500HP  
(LARGE)**

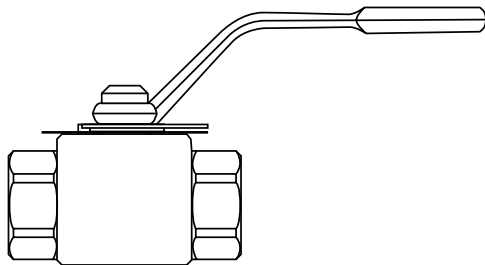

Pipe Thread	Part No.
1 1/4-11.5	VP500HP-20
1 1/2-11.5	VP500HP-24
2-11.5	VP500HP-32

**6000 PSI Female-Female  
Pipe Ends**

**V506HP  
(LARGE)**

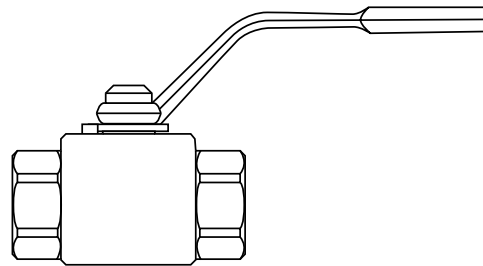

Straight Thread	Part No.
1 5/8-12UNF	V506HP-20
1 7/8-12 UNF	V506HP-24
2 1/2-12 UNF	V506HP-32

**6000 PSI  
Locking-Female-Female  
Pipe Ends**

**VP506HP**

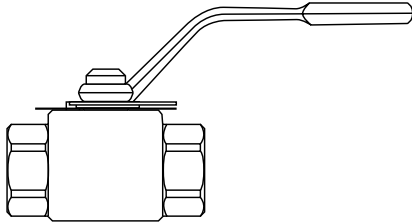

Straight Thread	Part No.
7/16-20 UNF	VP506HP-4
9/16-18 UNF	VP506HP-6
3/4-16 UNF	VP506HP-8
1 1/16-12 UNF	VP506HP-12
1 5/16-12 UNF	VP506HP-16

**Male-Female Straight Thread  
O-Ring Port**

**V510P**

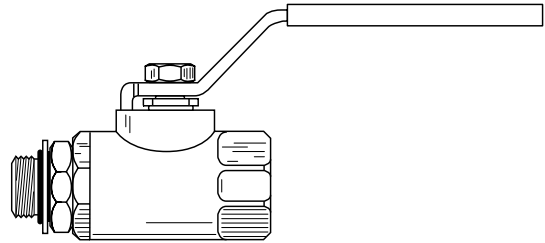

Straight Thread	Part No.
7/16-20	V510P-4
9/16-18	V510P-6
3/4-16	V510P-8
7/8-14	V510P-10
1 1/16-12	V510P-12
1 5/16-12	V510P-16

**6000 PSI  
Locking-Female-Female  
Pipe Ends**

**VP506HP  
(LARGE)**

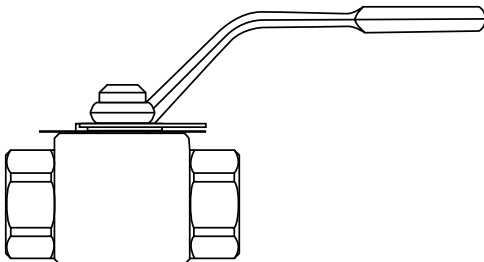

Straight Thread	Part No.
1 5/8-12UNF	VP506HP-20
1 7/8-12 UNF	VP506HP-24
2 1/2-12 UNF	VP506HP-32

**Vented, Straight Thread  
O-Ring Port**

**VV510P**

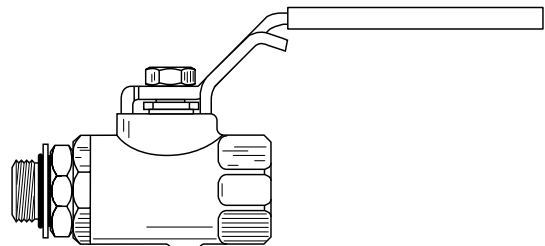

Straight Thread	Part No.
7/16-20	VV510P-4
9/16-18	VV510P-6
3/4-16	VV510P-8
7/8-14	VV510P-10
1 1/16-12	VV510P-12
1 5/16-12	VV510P-16



**Locking Handle,  
Straight Thread O-Ring Port**

**VP510P**

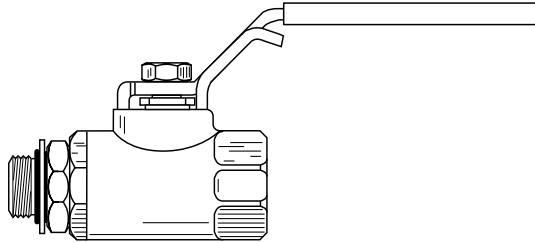

Straight Thread	Part No.
7/16-20	VP510P-4
9/16-18	VP510P-6
3/4-16	VP510P-8
7/8-14	VP510P-10
1 1/16-12	VP510P-12

**Tee Handle,  
Straight Thread O-Ring Port**

**V510P-X-04**

Straight Thread	Part No.
7/16-20	V510P-4-04
9/16-18	V510P-6-04
3/4-16	V510P-8-04
7/8-14	V510P-10-04
1 1/16-12	V510P-12-04
1 5/16-12	V510P-16-04

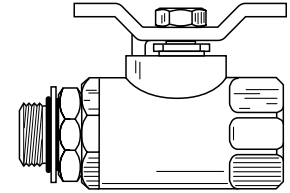

**Oval Handle,  
Straight Thread O-Ring Port**

**V510P-X-21**

Straight Thread	Part No.
7/16-20	V510P-4-21
9/16-18	V510P-6-21
3/4-16	V510P-8-21

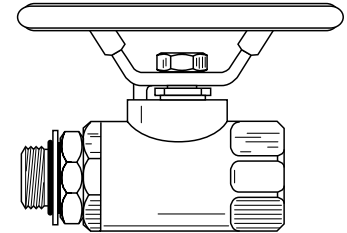

**OSHA 29 CFR Part 1910  
Vented, Locking Handle,  
Male-Female Straight Thread  
O-Ring Port**

**VVP510P**

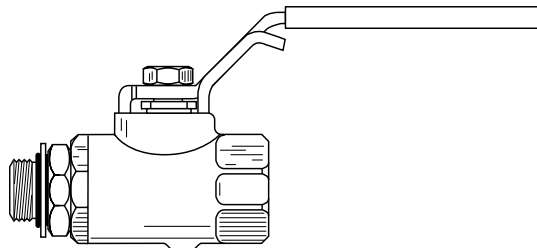

Straight Thread	Part No.
7/16-20	VVP510P-4
9/16-18	VVP510P-6
3/4-16	VVP510P-8
7/8-14	VVP510P-10
1 1/16-12	VVP510P-12

**Brass Ball Valve**

**V520P**

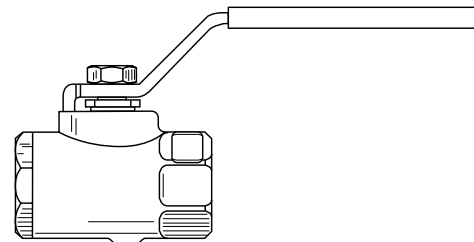

Straight Thread	Part No.
1/4-18	V520P-4
3/8-18	V520P-6
1/2-14	V520P-8
3/4-14	V520P-12
1-11.5	V520P-16
1-1/4	V520P-20
1-1/2	V520P-24
2	V520P-32

**90° Flow, Male-Female Pipe Ends**

**V590P**

Pipe Thread	Part No.
1/4	V590P-4
3/8	V590P-6
1/2	V590P-8

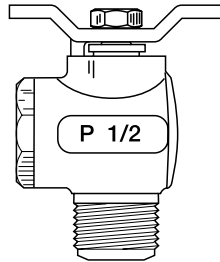

**Lever Handle, 90° Flow, Male-Male Pipe Ends**

**V591P-X-04**

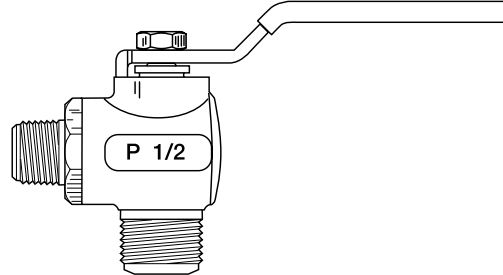

Pipe Thread	Part No.
1/4	V591P-4-04
3/8	V591P-6-04
1/2	V591P-8-04

**Lever Handle, 90° Flow, Male-Female Pipe Ends**

**V590P-X-04**

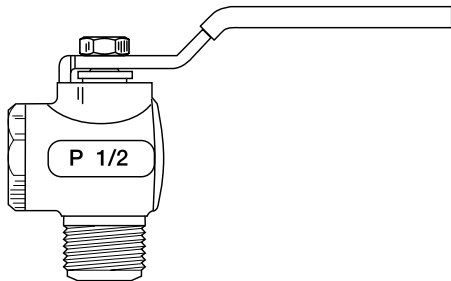

Pipe Thread	Part No.
1/4	V590P-4-04
3/8	V590P-6-04
1/2	V590P-8-04

**Brass Hose Barb Ball Valve**

**V500P-HB**

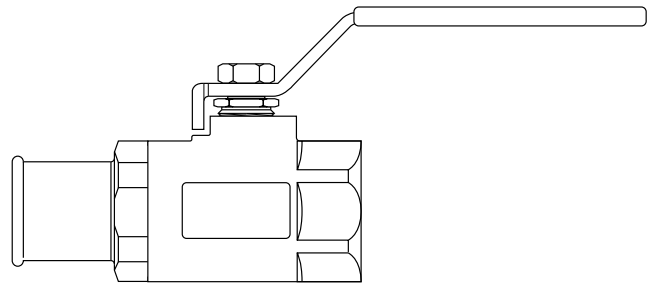

Port 1	Port 2 PTF	Part No.
1	3/4*	V500P-HB

\*PTF special extra short

**90° Flow, Male-Male Pipe Ends**

**V591P**

Pipe Thread	Part No.
1/4	V591P-4
3/8	V591P-6
1/2	V591P-8

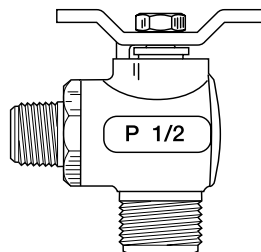

**Female-Female,  
Straight Thread O-Ring Port**

**V506P**

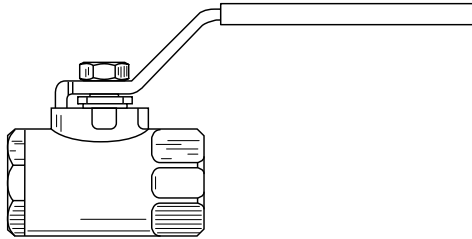

Straight Thread	Part No.
7/16-20	V506P-4
9/16-18	V506P-6
3/4-16	V506P-8
1 1/16-12	V506P-12
1 5/16-12	V506P-16

**Female-Female,  
Straight Thread O-Ring Port**

**V506P-20,  
-24, -32**

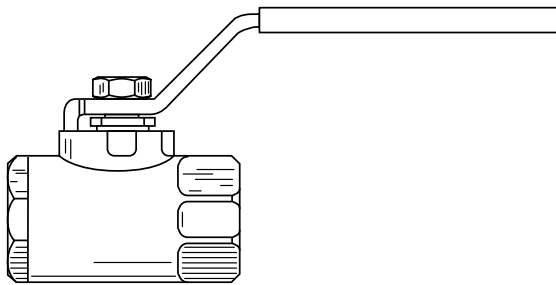

Straight Thread	Part No.
1 5/8-12	V506P-20
1 7/8-12	V506P-24
2 1/2-12	V506P-32

**OSHA 29 CFR Part 1910  
Vented, Locking Handle,  
Male-Female Pipe Ends**

**VVP501P**

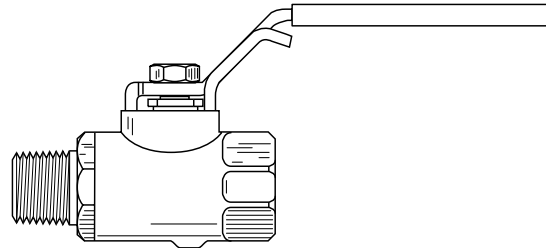

Pipe Thread	Part No.
1/4	VVP501P-4
3/8	VVP501P-6
1/2	VVP501P-8
3/4*	VVP501P-12
1*	VVP501P-16

\*Special Short

**Tee Handle, Male-Female  
Pipe Ends**

**V501P-X-04**

Pipe Thread	Part No.
1/4	V501P-4-04
3/8	V501P-6-04
1/2	V501P-8-04
3/4*	V501P-12-04
1*	V501P-16-04

\*Special Short

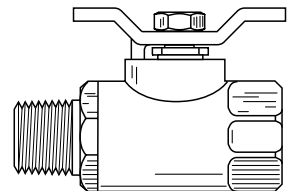

**Oval Handle, Male-Female  
Pipe Ends**

**V501P-X-21**

Pipe Thread	Part No.
1/4	V501P-4-21
3/8	V501P-6-21
1/2	V501P-8-21
3/4*	V501P-12-21
1*	V501P-16-21

\*Special Short

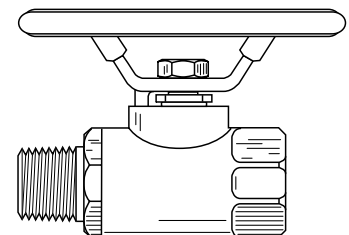

**Female-Female Pipe Ends,  
Panel Mount**

**V502P**

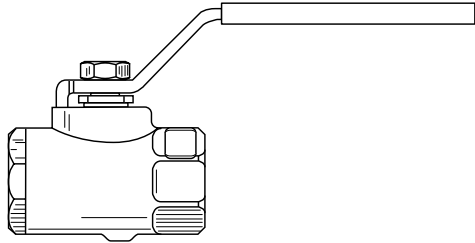

Pipe Thread	Part No.
1/4	V502P-4
3/8	V502P-6
1/2	V502P-8
3/4*	V502P-12
1*	V502P-16

\*Special Short

**Locking Handle, Female  
Pipe Ends, Panel Mount**

**VP502P**

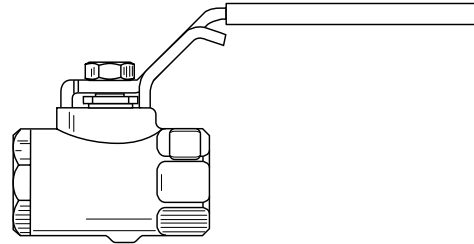

Pipe Thread	Part No.
1/4	VP502P-4
3/8	VP502P-6
1/2	VP502P-8
3/4*	VP502P-12
1*	VP502P-16

\*Special Short

**Vented, Female-Female  
Pipe Ends, Panel Mount**

**VV502P**

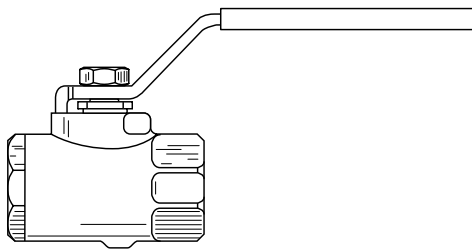

Pipe Thread	Part No.
1/4	VV502P-4
3/8	VV502P-6
1/2	VV502P-8
3/4*	VV502P-12
1*	VV502P-16

\*Special Short

**OSHA 29 CFR Part 1910  
Vented, Locking Handle,  
Female Pipe Ends,  
Panel Mount**

**VVP502P**

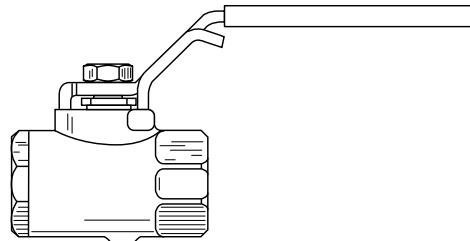

Pipe Thread	Part No.
1/4	VVP502P-4
3/8	VVP502P-6
1/2	VVP502P-8
3/4*	VVP502P-12
1*	VVP502P-16

\*Special Short

**Tee Handle, Female Pipe Ends, Panel Mount**

**V502P-X-04**

Pipe Thread	Part No.
1/4	V502P-4-04
3/8	V502P-6-04
1/2	V502P-8-04
3/4*	V502P-12-04
1*	V502P-16-04

\*Special Short

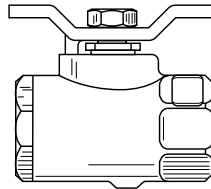

**Self-Piercing Humidifier Valve Clamp Kit**

**SPV104C-Kit**

Pipe Thread	Tube Size	Part No.
1/8	1/4	SPV104C KIT

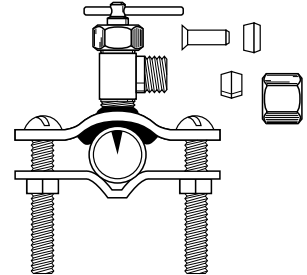

**Oval Handle, Female Pipe Ends, Panel Mount**

**V502P-X-21**

Pipe Thread	Part No.
1/4	V502P-4-21
3/8	V502P-6-21
1/2	V502P-8-21
3/4*	V502P-12-21
1*	V502P-16-21

\*Special Short

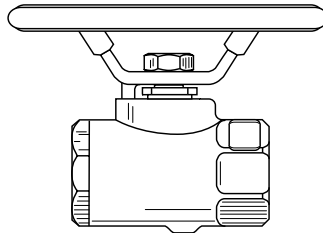

**Angle-Needle Valve (Compression to Male Pipe)**

**NV104C**

Pipe Thread	Tube Size	Part No.
1/8	1/4	NV104C-4-2*
1/4	1/4	NV104C-4-4
1/8	5/16	NV104C-5-2*
1/4	3/8	NV104C-6-4

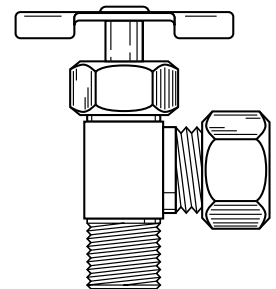

**Humidifier Valve Clamp Kit**

**HV104C-Kit**

Pipe Thread	Tube Size	Part No.
1/8	1/4	HV104C-4-2 KIT

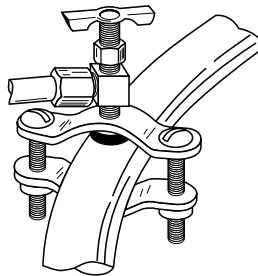

**Angle Needle Valve (Flare to Male Pipe)**

**NV101F**

Pipe Thread	Tube Size	Part No.
1/8	1/4	NV101F-4-2
1/4	3/8	NV101F-6-4

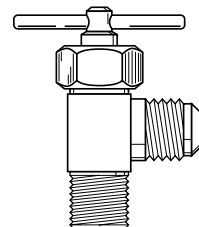

**Needle Valve  
(Flare to Male Pipe)  
\*Provided with Pin Handle**

**NV102F**

Tube Size	Part No.
1/4	NV102F-4*
3/8	NV102F-6

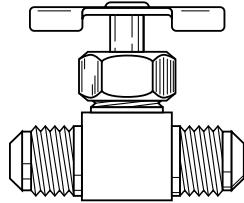

**Needle Valve  
(Compression to Compression) \*Provided with Pin Handle**

**NV105C**

Tube Size	Part No.
1/4	NV105C-4*
5/16	NV105C-5*
3/8	NV105C-6

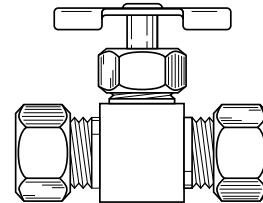

**Needle Valve  
(Flare to Male Pipe)  
\*Provided with Pin Handle**

**NV103F**

Pipe Thread	Tube Size	Part No.
1/8	1/4	NV103F-4-2*
1/4	3/8	NV103F-6-4

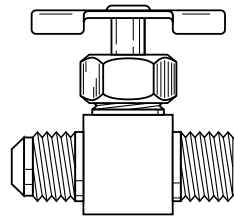

**Needle Valve  
(Compression to Male Pipe)  
\*Provided with Pin Handle**

**NV106C**

Pipe Thread	Tube Size	Part No.
1/8	1/4	NV106C-4-2*
1/4	1/4	NV106C-4-4*
1/8	5/16	NV106C-5-2*
1/4	3/8	NV106C-6-4

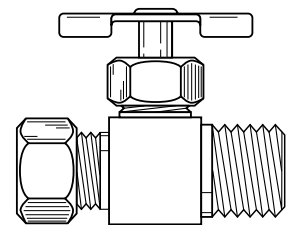

**Humidifier Valve  
(Compression to Male Pipe)**

**HV104C**

Pipe Thread	Tube Size	Part No.
1/8	1/4	HV104C-4-2

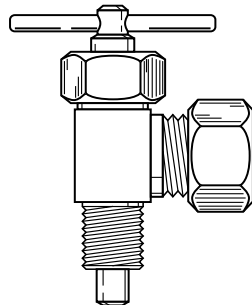

**Humidifier Valve  
(Male Pipe to Male Pipe)  
\*Provided with Pin Handle**

**NV107P**

Pipe Thread	Part No.
1/8	NV107P-2*
1/4	NV107P-4

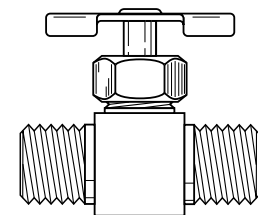

**Needle Valve  
(Female Pipe to Male Pipe)  
\*Provided with Pin Handle**

**NV108P**

Pipe Thread	Part No.
1/8	NV108P-2*
1/4	NV108P-4

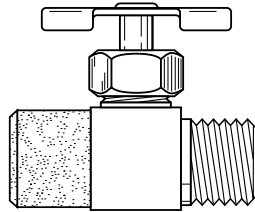

**Angle Needle Valve  
(Poly-Tite to Male Pipe)**

**NV312P**

Pipe Thread	Tube Size	Part No.
1/8	1/4	NV312P-4-2
1/4	1/4	NV312P-4-4
1/4	3/8	NV312P-6-4

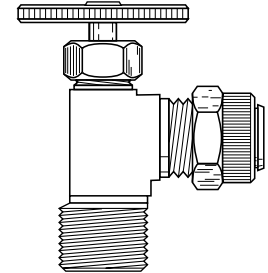

**Needle Valve  
(Female Pipe to Female Pipe)  
\*Provided with Pin Handle**

**NV109P**

Pipe Thread	Part No.
1/8	NV109P-2*
1/4	NV109P-4

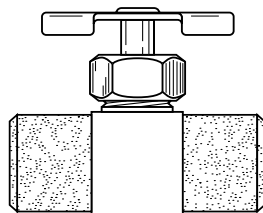

**Truck Valve  
(Hose to Male Pipe)**

**V404P**

Pipe Thread	Hose I.D.	Part No.
3/8	3/8	V404P-6-6
3/8	5/8	V404P-10-6

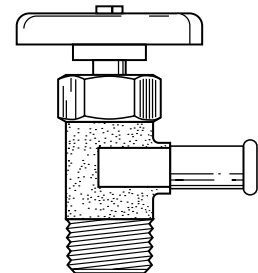

**Needle Valve  
(Poly-Tite to Male Pipe)**

**NV311P**

Pipe Thread	Tube Size	Part No.
1/8	1/4	NV311P-4-2
1/4	1/4	NV311P-4-4
1/4	3/8	NV311P-6-4

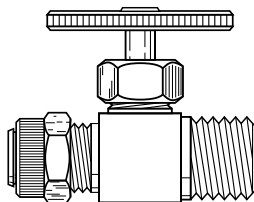

**Truck Valve  
(Hose to Male Pipe with Pin Handle)**

**V404PH**

Pipe Thread	Hose I.D.	Part No.
3/8	5/8	V404PH-10-6

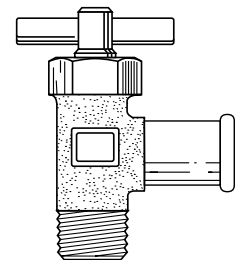

**Truck Valve  
(Hose to Male Pipe)**

**SV404P**

Pipe Thread	Hose I.D.	Part No.
1/2	5/8	SV404P-10-8
3/8	3/4	SV404P-12-6
1/2	3/4	SV404P-12-8

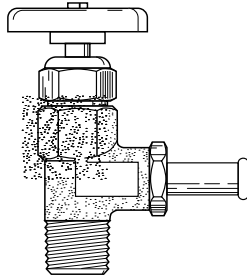

**Truck Valve  
(Flare to Male Pipe)**

**V409F**

Pipe Thread	Tube Size	Part No.
3/8	1/2	V409F-8-6
1/2	1/2	V409F-8-8
1/2	5/8	V409F-10-8
3/8	3/4	V409F-12-8

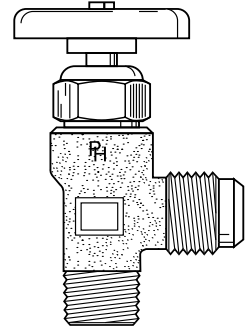

**Truck Valve  
(Female Pipe to Male Pipe)**

**V405P**

Female Pipe Thread	Male Pipe Thread	Part No.
3/8	3/8	V405P-6-6
3/8	1/2	V405P-6-8
1/2	1/2	V405P-8-8

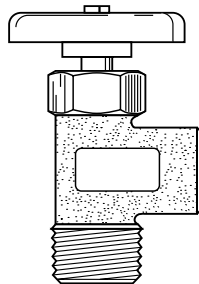

**Truck Valve  
(Tube to Male Pipe)**

**V410NTA**

Pipe Thread	Tube Size	Part No.
1/2	1/2	V410NTA-8-8

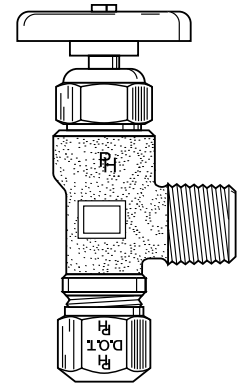

**Truck Valve  
(Tube to Male Pipe)**

**V408NTA**

Pipe Thread	Tube Size	Part No.
1/2	1/2	V408NTA-8-8
1/2	5/8	V408NTA-10-8

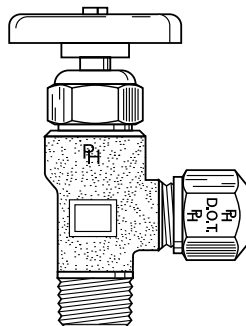

**Truck Valve  
(Tube to Male Pipe)**

**V412F**

Pipe Thread	Tube Size	Part No.
1/2	5/8	V412F-10-8

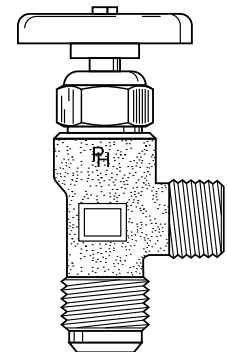



**Truck Valve  
(Female Pipe to Male Pipe)**

**XV590P-8**

Female Pipe Thread	Male Pipe Thread	Part No.
1/2	1/2	XV590P-8

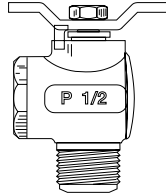

**Ground Plug Shutoff Cock  
(Flare to Flare)**

**V203F**

Tube Size	Part No.
1/4	V203F-4-4
3/8	V203F-6-6
1/2	V203F-8-8

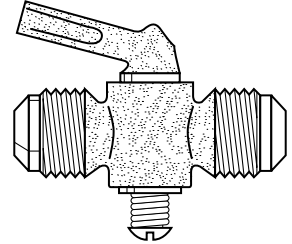

**Lanyard Valve**

**LV91**

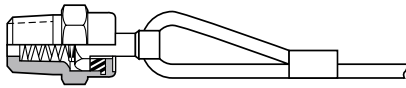

**Nomenclature**

Part numbers are constructed from symbols that identify size of fitting and length of cable.

**Example:** LV91 -4 -060

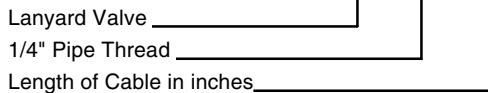

1/4	36"	LV91-4-036
1/4	48"	LV91-4-048
1/4	60"	LV91-4-060

**Brass Shutoff Cock  
(Flare to Flare)**

**V201F**

Tube Side	Part No.
3/8	V201F-6-6
1/2	V201F-8-8

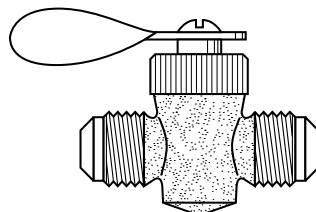

**Ground Plug Shutoff Cock  
(Flare to Male Pipe)**

**V204F**

Pipe Thread	Tube Size	Part No.
1/8	1/4	V204F-4-2
1/4	3/8	V204F-6-4

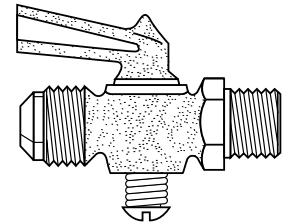

**Ground Plug Shutoff Cock  
(Compression to Compression)**

**V303C**

Tube Size	Part No.
1/4	V303C-4-4
3/8	V303C-6-6

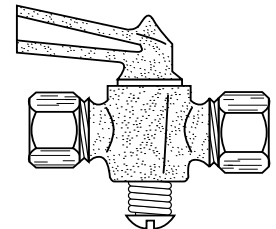

**Ground Plug Shutoff Cock  
 (Compression to Male Pipe)**

**V304C**

Pipe Thread	Tube Size	Part No.
1/8	1/4	V304C-4-2
1/4	1/4	V304C-4-4
1/4	3/8	V304C-6-4

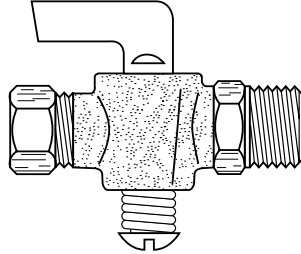

**Ground Plug Shutoff Cock  
 (Female Pipe to Female Pipe)**

**V403P**

Female Pipe Thread	Part No.
1/8	V403P-2-2
1/4	V403P-4-4
3/8	V403P-6-6*

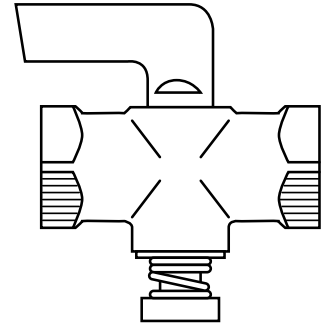

**Ground Plug Shutoff Cock  
 (Male Pipe to Male Pipe)**

**V401P**

Pipe Thread	Part No.
1/8	V401P-2-2
1/4	V401P-4-4

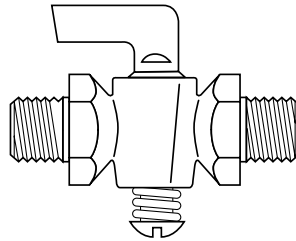

**Three-Way Valve  
 (Female Pipe Three Ends)**

**V406P**

Pipe Thread	Part No.
1/4	V406P-4

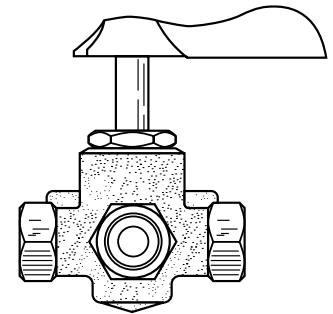

**Ground Plug Shutoff Cock  
 (Female Pipe to Male Pipe)**

**V402P**

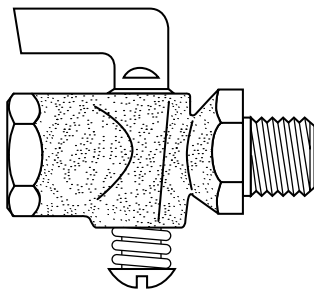

Female Pipe Thread	Pipe Thread	Part No.
1/8	1/8	V402P-2-2
1/4	1/4	V402P-4-4
3/8	3/8	V402P-6-6

**Four-Way Valve  
 (Female Pipe Four Ends)**

**V407P**

Pipe Thread	Part No.
1/4	V407P-4

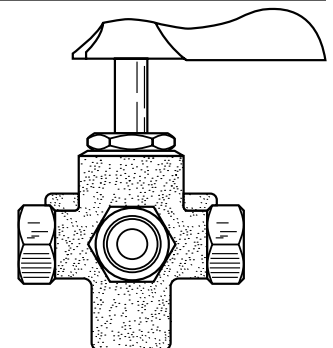

**Drain Cock**

**DC601**

Pipe Thread	Part No.
1/8	DC601-2
1/4	DC601-4
3/8	DC601-6
1/2	DC601-8

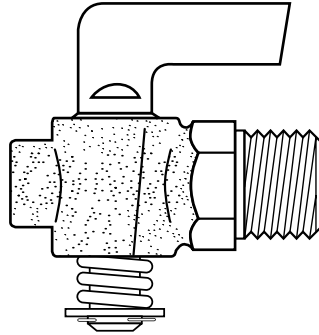

**Drain Cock**

**DC603**

Pipe Thread	Part No.
1/8	DC603-2
1/4	DC603-4
3/8	DC603-6

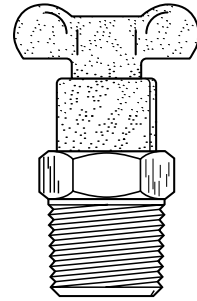

**Drain Cock**

**DCR601**

Pipe Thread	Part No.
1/4	DCR601-4

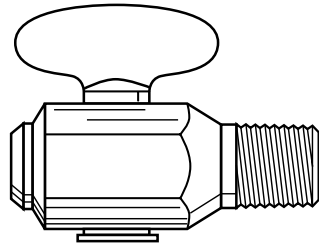

**External Seat Drain Cock**

**DC606**

Pipe Thread	Part No.
1/4-18	DC606-4

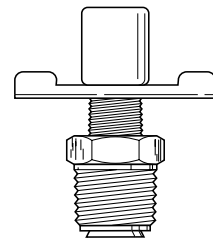

**Internal Seat Drain Cock**

**DC602**

Pipe Thread	Part No.
1/8	DC602-2
1/4	DC602-4

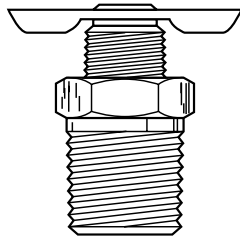

**Bib Drain Cock**

**DC607**

Pipe Thread	Tube Size	Part No.
1/4	3/8	DC607-4

