



PARKER LEGRIS Industrial Connector Systems

Products are available from:

MARYLAND METRICS

P.O. Box 261 Owings Mills, MD 21117 USA email: sales@mdmetric.com
ph: (410)358-3130 (800)638-1830 fx: (410)358-3142 (800)872-9329
web: <http://mdmetric.com> RFQ form: <http://mdmetric.com/rfq.htm>

How to order: Please preface each PARKER LEGRIS Catalog part number with 'R053-' Example: R053-3175 04 10



Parker Legris: Connection Solutions for Industrial Fluids

aerospace
climate control
electromechanical
filtration
fluid & gas handling
hydraulics
pneumatics
process control
sealing & shielding



See the next page for D.O.T. part number information.

ENGINEERING YOUR SUCCESS.

D.O.T. LEGRIS to PARKER part number interchange.

With the acquisition of Legris by Parker Hannifin the Legris DOT part numbers have been superseded by Parker part numbers.

Click the link below to access the Parker catalog containing the superseded Legris DOT part numbers:

http://mdmetric.com/prod/legris/parker-legris_3501E-D.pdf

Part numbers in that catalog containing "PTC" or "PMT" are replacements for the superseded Legris DOT part numbers.

They are available from MARYLAND METRICS.



PARKER LEGRIS Industrial Connector Systems

Products are available from:

MARYLAND METRICS

P.O. Box 261 Owings Mills, MD 21117 USA email: sales@mdmetric.com

ph: (410)358-3130 (800)638-1830 fx: (410)358-3142 (800)872-9329

web: <http://mdmetric.com> RFQ form: <http://mdmetric.com/rfq.htm>

How to order: Please preface each PARKER LEGRIS Catalog part number with 'R053-' Example: R053-3175 04 10



Serving as a true shop window for Parker Legris' knowledge and expertise, this new catalogue strives to provide the day-to-day support you need when designing your industrial equipment.

This new edition has been written in an informative style and describes our entire range of products and services. We have developed the content, structure and layout to enable you to find the products and information you require as quickly as possible.

Many new products have been introduced, widening the choice of solutions available in order to meet your requirements more effectively.

For advice or more information, please do not hesitate to contact us. Visit Maryland Metrics web site today: <http://mdmetric.com>.



A Century of Dedication and Enthusiasm...

Inventor of the push-in fitting, Legris joined the Parker Hannifin Corporation, world leader in motion and control technologies, in October 2008.

3 Industrial Activities

Optimising the transport and control of many fluids (compressed air, liquids, gas) through innovative product design has been the motto of our teams for more than 100 years.

Today, Parker Legris' expertise is divided into three business activities:

Legris Connectic: fittings, couplers, function fittings, valves, tubing and accessories for industrial applications.

Legris Transair: air and fluid distribution systems for industrial buildings.

Legris Autoline: push-in connection solutions for automobile fuel lines.

150 Years of History

Our experience and expertise in the design, manufacturing and marketing of high-quality connectors allow us to provide our customers with solutions adapted to a variety of applications.

1848 Legris, a small valve manufacturer in France

1969 Invention of LF 3000®, the first push-in fitting for compressed air

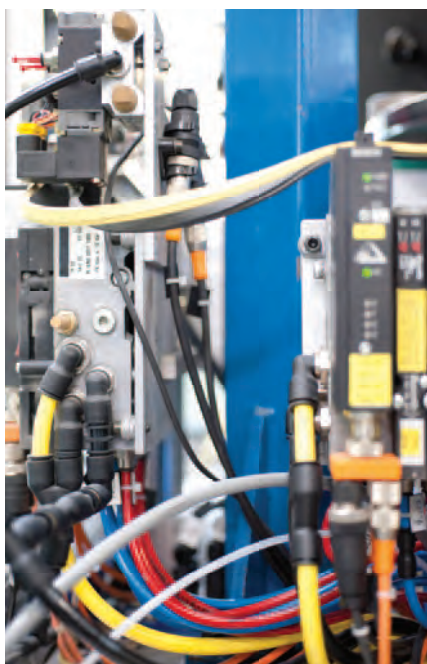
1988 Legris becomes a division of the Legris Industries Group

1996 Launch of Transair®

1997 Launch of Autoline

2008 Acquisition of Legris by the Parker Hannifin Corporation

2009 Legris becomes Parker Legris, a division of the Parker group



...Supporting Industrial Connectivity

Parker Legris Sites

Parker Legris has 9 locations distributed across Europe.

France: Annemasse, Baillé, Guer, Guichen, Malestroit, Muzillac, Rennes

Belgium: Herstal

Spain: Terrassa

Industrial Applications

Our products are used everywhere fluid control is required.

Our knowledge and expertise are deployed in a variety of sectors: production automation, packaging, transport, food process, and the medical industry.

Parker Legris is also involved in innovative sectors such as renewable energy, information and communication technologies.

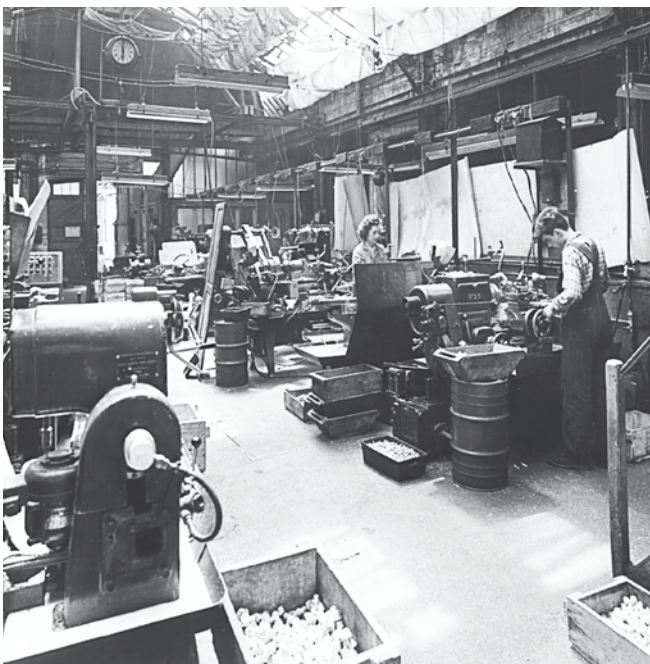
Our Distribution Network

We encourage local support and long-term partnerships with our customers.

Through our many sales outlets, professionals are on hand to provide you with technical advice and to offer you a wide choice of products local to your sites.

Do not hesitate to contact them for further information and advice.

1940



2012



Your Applications Inspire Our Innovation

Innovation is Parker-Legris' number one priority in order to provide solutions that meet your technological, energy reduction and environmental challenges.

Our expertise is continually improving

We continually invest in our tools in order to anticipate market requirements in terms of industrial efficiency. Furthermore, our long-term partnerships with the most qualified organisations (universities, skills hubs, etc.) enable us to incorporate the latest technological advances in our product development. Lastly, constantly incorporating your needs into the design of our products keeps us at the forefront of the new industrial challenges.

Together, we can build advanced and unique connector solutions

Here are a few examples:

To increase the efficiency of your systems

The new LIQUIfit+, with its ecological design, combines full flow and quick connection to stainless steel tubes without grooving. This range guarantees the quality and non-contamination of the fluids conveyed, plus reduced operating costs.

To prolong the life of your equipment

Developed for railway applications and demanding industrial markets, our new high strength flame-resistant tubing combines unequalled flame resistance with very high mechanical strength and ease of installation.

To limit energy costs

The new range of energy-saving blowguns allows you to reduce the air flow, thus limiting its energy consumption while maintaining blowing efficiency.

This catalogue also contains details of our latest products:

LF 3000® 16 mm, LIQUIfit®, PFA tubing, piloted non-return valve, adjustable non-return valve, blowgun kits and many other components.



Quality and Safety, the Basis of Our Commitment

Our target is to provide our customers with the best solution and the highest quality. Certified ISO/TS 16949, Parker Legris includes customer quality at the heart of its processes.

Invest in quality for increased productivity

The cost of a production stoppage due to a defective part is greater than the cost of all the connectors in the machine. Choosing the quality of the components in your machine is thus of primary importance; it also guarantees the safety of your employees. Furthermore, investing in quality increases your productivity over the long term and contributes to maintaining your brand image.

We guarantee the quality and traceability of our solutions

Our products are fully inspected and dated individually during production in order to ensure quality and traceability.

We commit our name and our image to yours through the quality of our products.

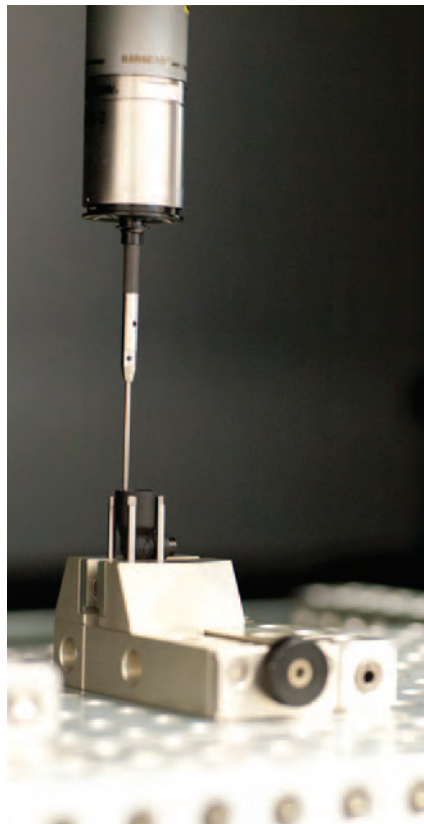
We protect your connectors to give you peace of mind

Our company exceeds its statutory responsibilities with regard to the safety of individuals and systems.

Certification and qualification processes are integrated upstream of our developments.

We ensure the performance of your installations

Our product ranges are designed with a high safety factor and comply with quality management processes.



Our Services Contribute to Your Performance

Our services integrate easily into your processes. Whether during the design phase, for promotion, or for administrative, business, or stock management of your components, our skills are here for you to use.

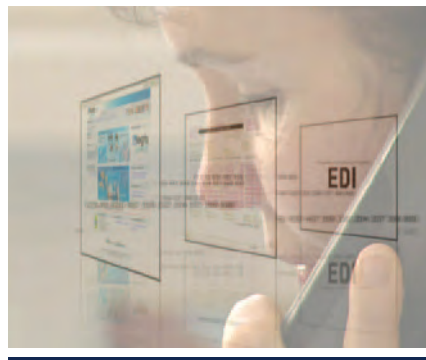
Customised Products

We can help you develop customised solutions: fittings, manifolds, valves, etc.



EDI Transmission

Implementation of computerised data exchange.



Improved Stock Management

Packaging, bar codes and customised labels according to your needs.



Technical Specifications

All the technical data for our products is available on-line.



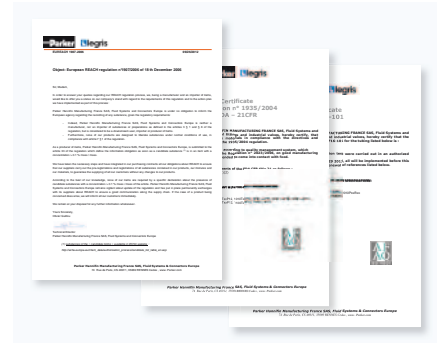
2D and 3D Drawings

The CAD drawings of our products are available on-line in the 21 main formats used by the industry (Solidworks, Autocad, Pro/E, etc.).



Certificates and Regulations

Certificates of conformity for our products are available on our web site. Contact us for any further information you require.



e-Tools

Requests for quotations, stock availability, energy-saving calculators, searching for cross-references, etc. are available on-line.



Communication Tools

We can provide you with any promotional sales material you require: brochures, flash animations, sample kits, etc.



e-Catalogue

Integration of our product data into your information systems (e-procurement, e-commerce site, etc.).



Parker Legris

Industrial Connector Systems



Directives and Regulations: the Parker Legris Offer

Parker Legris complies with the directives and regulations listed below and goes beyond its statutory obligations for the ranges in question.



European RoHS directives: 2011/65/EC
Relating to the limitation of the use of 6 hazardous substances in electrical and electronic equipment (mercury, lead, cadmium, hexavalent chromium, PBB and PBDE).



NSF 61: NSF / ANSI-61
Fittings and tubes complying with this standard are tested and approved by NSF for contact with drinking water.



REACH regulation: no. 1907/2006
As product manufacturer, we are subject to article 33 of the regulation which defines a duty to inform when a candidate substance is present at more than 0.1% weight for weight.



NSF 42 and 58: NSF/ANSI-42/58
Tubes complying with this standard are tested and approved by NSF for drinking water treatment systems.



Pressurised equipment directive: 97/23/EC
This directive regulates the design, manufacture and assessment of pressurised equipment to ensure operating safety.



ACS: Attestation de Conformité Sanitaire (France)
Official approval issued by the Direction générale de la Santé Française (French Health Directorate), applies to constituent materials of equipment in contact with water intended for human consumption.



ATEX directive: 94/9/EC mandatory since 01/07/2003
This directive is mandatory for electrical and non-electrical equipment used in explosive gaseous or dusty atmospheres. The use of our products in these areas must be determined in accordance with the ATEX environment.



KTW: Kunststoffe und Trinkwasser (Germany)
Guidelines for the health evaluation of equipment in contact with drinking water, assessment and certification carried out by the TZW.



Regulation 1935/2004
This framework regulation relates to materials and objects designed to come into contact with foodstuffs. It describes specific measures per product group (Art. 5).



W270: Food contact standard (Germany)
Standard describing a test method for determining the microbial growth on non-metal materials designed to come into contact with drinking water. Test and certification carried out by the TZW.



CFR 21: Code of Federal Regulation Title 21: Food and Drugs
This code consists of lists of prohibited substances for materials intended to come into contact with foodstuffs.



WRAS: Water Regulations Advisory Scheme (UK)
Fittings approved by this programme are declared compliant for water supply by WRc - NSF.



NSF 51: NSF / ANSI-51
Fittings and tubes complying with this standard are tested and approved by NSF for contact with drinks and foodstuffs.



DM 174: Ministerial decree (Italy)
Declaration of hygiene compliance for equipment used for drinking water, tested and certified by the TIFQ.

The Parker Legris product range offers compliance with numerous European standards associated in particular with the directives and regulations referred to above. The official texts of these directives are available on the site: <http://eur-lex.europa.eu>.



Together, We Can Build Sustainable Development

Parker Legris, ISO 14001 certified, has made the conservation of resources and protection of the environment a major priority. We have incorporated improved environmental management as a permanent feature in the vision and mission of the company, aiming to benefit nature, technology and mankind.



Protecting natural resources

By saving energy through the performance of our production facilities.

Improving performance

By changing habits in order to promote new materials and concepts.

Asserting our values for the protection of the environment

By having all our sites ISO 14001 certified in order to unify all our employees around clear objectives regarding the management of the environment.

Our actions are coupled with your environmental process

Reducing the impact on industrial sites

Parker Legris has integrated environmental protection management into the operation of its industrial sites. This approach has enabled 85% of waste to be recovered and has reduced energy consumption by 15%.

Offering ecologically responsible products

Under its continuous improvement process, Parker Legris has integrated ecological design as an input parameter to innovation and uses Life Cycle Assessment (LCA) to optimise the environmental impact of its products.

Providing information on the PEP (Product Environmental Profile)

This communication tool is common to all industries and professions and delivers a reliable and clear message for promoting ecological advances and incorporating this data within the LCA equipment.

Getting ahead of regulations

Parker Legris goes beyond its statutory obligations and endeavours to find a good match between choice of materials, limitation of hazardous substances, selection of recycling channels and industrial performance to encourage the recycling of products at end of life.

Using our technology reduces the environmental impact

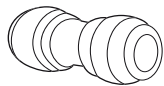
LIQUIfit®

Tube-to-Tube Connector



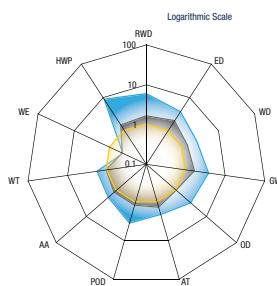
Market Standard

Tube-to-Tube Connector



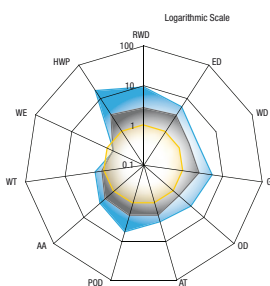
- Parker Legris
- Market Standard in PP
- Market Standard in POM

Stud Elbow



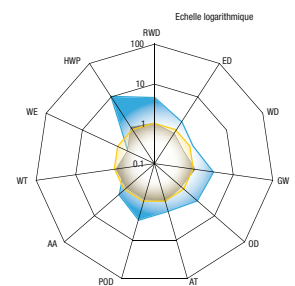
- RWD: Raw Material Depletion
- ED: Energy Depletion
- WD: Water Depletion
- GW: Global Warming

Tube-to-Tube Connector



- OZ: Ozone Depletion
- AT: Air Toxicity
- POC: Photochemical Ozone Creation
- AA: Air Acidification

Stud Fitting



- WT: Water Toxicity
- WE: Water Eutrophication
- HWP: Hazardous Waste Production

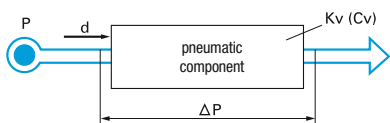


Technical Guidelines

Compressed Air Flow and Pressure Drop

Flow represents the quantity of compressed air passing through a section per unit time. It is expressed in l/min, m³/min or m³/h, at the value expressed in free air, under Standard Reference Atmospheric conditions (ANR) namely: **+20°C, 65% relative humidity, 1.013 bar**, according to standards NFE 48100 and ISO R554, R558.

When in open position and subject to a supply pressure (**P**), the pneumatic component provides a flow (**d**) which generates a pressure drop at the outlet. The pressure difference therefore between the inlet orifice (upstream pressure) and the outlet orifice (downstream pressure), is called the **pressure drop** and is designated by **ΔP** (pressure differential).



The **maximum allowable working pressure** of a component is the effective pressure to which this component may be subjected in a given installation.

The **upstream pressure** is the compressed air pressure at the component inlet.

The **downstream pressure** is the outlet pressure from the component.

The **differential pressure (ΔP)** is the pressure difference between the upstream and downstream pressures.

In order to have simple and usable values available for carrying out calculations and comparing the performances of pneumatic components, we use a flow factor called **Kv**. This experimental factor characterises the flow capacity of a component. It equates to the practical value of the flow of water in litres/minute under a Δp of 1 bar with bore fully open.

The flow factor Kv equates to a coefficient of conductivity - the higher its value, the better the flow provided by the component.

The Kv and pressure drop are linked by the following relationship:

$$Q_v = 26.7 K_v \sqrt{\Delta p \times P_{\text{upstream}}}$$

Q_v = flow in l/min (ANR)

K_v = flow factor

Δp = in bar

P_{upstream}: in bar absolute

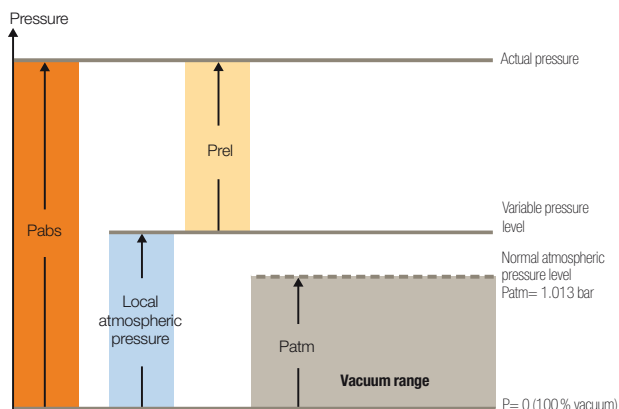
C_v is a flow factor equivalent to Kv, but expressed in US gallons per minute under a Δp of 1 PSI. Kv and Cv are therefore linked by the following relationships:

$$K_v = 14.3 C_v \quad - \quad C_v = 0.07 K_v$$

The flow indicated for certain products in the Parker Legris catalogue is the average flow at 6 bar expressed in NI/min of depressurised air at the Standard Reference Atmosphere (ANR).

Pressure

The normal atmospheric pressure of the air is 1.013 bar at sea level (0 m altitude). It is generally used as a reference for pressure measurements but varies with altitude. For tests and measurements, it is preferable to use absolute bar which relates to an absolute pressure.



$$P_{\text{abs}} = P_{\text{atm}} + P_{\text{rel}}$$

P_{abs} : absolute pressure

P_{rel} : relative pressure

P_{atm} : atmospheric pressure

The pressure is expressed in bar according to industrial practice. It is the result of a force of daN applied to a surface area in cm².

$$1 \text{ bar} = \frac{1 \text{ daN}}{1 \text{ cm}^2} = 10^5 \text{ pascal}$$

Vacuum and Vacuum Levels

Vacuum appears when the atmosphere is rarefied. By removing the air from an enclosed space, a depression (or vacuum) is created relative to atmospheric pressure.

Vacuum therefore relates to the state of a fluid where the pressure is less than atmospheric pressure.

The vacuum level may be expressed as:

depression level = relative pressure value compared to atmospheric pressure

vacuum level in absolute value (defined in comparison with absolute zero)

The common unit of vacuum is the millimetre of mercury (**mm Hg**).

Classification of vacuum

- medium vacuum 1013 to 10 mbar absolute
- primary vacuum 10 to 10⁻³ mbar absolute
- secondary vacuum 10⁻³ to 10⁻⁶ mbar absolute
- molecular vacuum 10⁻⁶ to 10⁻⁹ mbar absolute
- ultra-vacuum < 10⁻⁹ mbar absolute

Conversion Tables

Units Used in this Catalogue

Symbol	Unit
A	ampere
bar	bar
°C	degree Celsius
dBA	decibel
Hz	hertz
kg	kilogram
m	metre
m ²	square metre
m ³ /h	cubic metres per hour
min	minute
mm	millimetre
mm Hg	millimetres of mercury
N	Newton
NI	litres at standard reference atmospheric pressure (ANR)*
V	volt

* Parker Legris carries out its tests under normal pressure and temperature conditions (1013 mbar, +20°C). All flows mentioned in this catalogue are therefore expressed in NI/min.

Units of Flow

L/min	Cfm	m ³ /h
600	21	36
1200	43	72
1800	64	108
2400	85	144
3000	106	180
3600	128	216
4200	149	252
4800	170	288
5400	191	324
6000	213	360
6600	234	396
7200	255	432
7800	277	468

Units of Vacuum

Depression (mm Hg)	Vacuum (%)	Absolute Pressure (mbar)	Depression (mbar)
0	0	1000	0
-75	10	900	-100
-100	13.3	867	-133
-150	20	800	-200
-200	26.7	733	-267
-225	30	700	-300
-300	40	600	-400
-375	50	500	-500
-400	53.3	467	-533
-450	60	400	-600
-500	66.7	333	-667
-525	70	300	-700
-600	80	200	-800
-675	90	100	-900
-690	92	80	-920

Units of Pressure

1 bar = 100.000 Pa = 100 kPa = 14.5 psi
 1 Pa = 0.00001 bar = 0.000145 psi
 1 psi = 0.069 bar = 6897.8 Pa

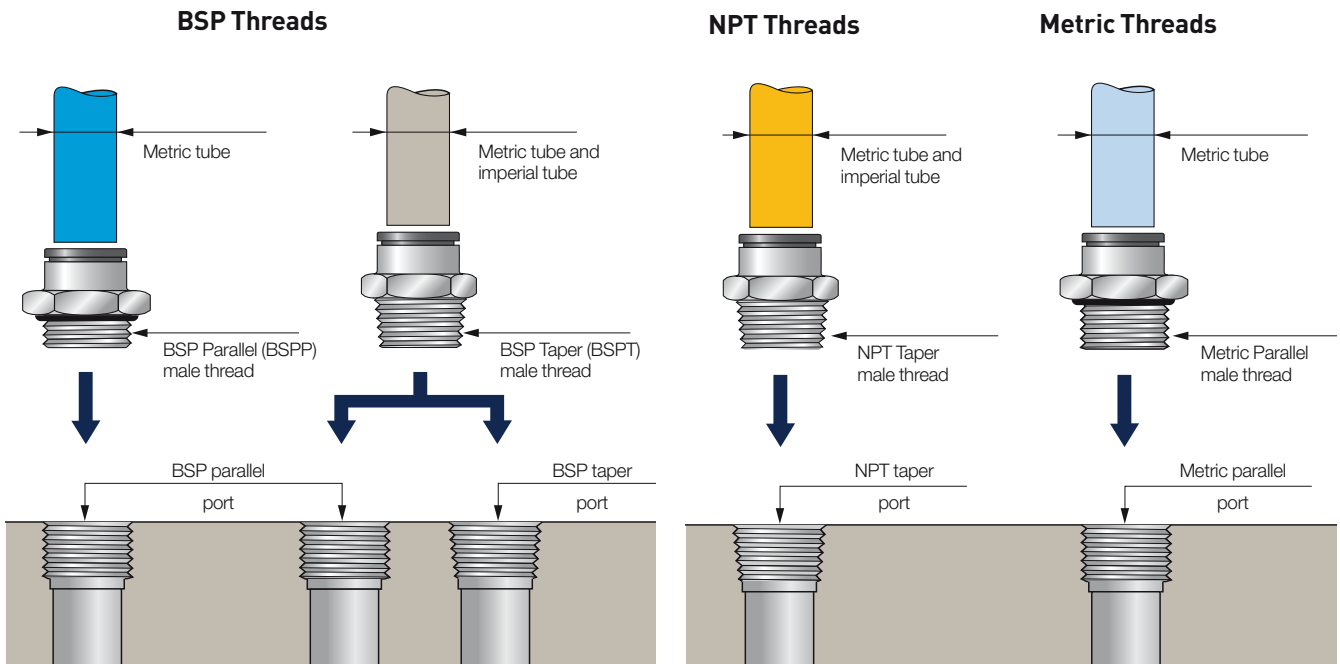
bar	kPa	psi	psi	kPa	bar
0.0005	0.05	0.0073	0.007	0.05	0.0005
0.001	0.10	0.0145	0.015	0.1	0.0010
0.005	0.5	0.0725	0.070	0.48	0.0048
0.01	1	0.145	0.150	1.04	0.0104
0.05	5	0.725	0.700	4.83	0.0483
0.069	6.9	1.000	1.000	6.90	0.0690
0.1	10	1.450	1.500	10.35	0.1035
0.25	25	3.625	3.000	20.70	0.2070
0.5	50	7.250	7.000	48.30	0.4830
0.75	75	10.875	10.000	69.00	0.6900
1.0	100	14.500	15.000	103.50	1.0350
1.5	150	21.750	20.000	138.00	1.3800
2.0	200	29.000	25.000	172.50	1.7250
2.5	250	36.250	30.000	207.00	2.0700
3.0	300	43.500	35.000	241.50	2.4150
3.5	350	50.750	40.000	276.00	2.7600
4.0	400	58.000	50.000	345.00	3.4500
4.5	450	65.250	60.000	414.00	4.1400
5.0	500	72.500	70.000	483.00	4.8300
5.5	550	79.750	80.000	552.00	5.5200
6.0	600	87.000	90.000	621.00	6.2100
7.0	700	101.500	100.000	690.00	6.9000
8.0	800	116.000	110.000	759.00	7.5900
9.0	900	130.500	125.000	862.50	8.6250
10.0	1000	145.000	150.000	1035	10.3500
12.0	1200	174.000	175.000	1207.5	12.0750
14.0	1400	203.000	200.000	1380	13.8000
16.0	1600	232.000	225.000	1552.5	15.5250
18.0	1800	261.000	250.000	1725	17.2500
20.0	2000	290.000	300.000	2070	20.7000

Units of Temperature

0 °C = +23 °F
 0 °F = -17.8 °C

°F	°C	°C	°F
-40	-40.0	-40	-40
-30	-34.4	-30	-22
-20	-28.9	-20	-4
-10	-23.3	-10	+14
0	-17.8	0	+32
+10	-12.2	+10	+50
+20	-6.7	+20	+68
+30	-1.1	+30	+86
+40	+4.4	+40	+104
+50	+10.0	+50	+122
+60	+15.6	+60	+140
+70	+21.1	+70	+158
+80	+26.7	+80	+176
+90	+32.2	+90	+194
+100	+37.8	+100	+212
+110	+43.3	+110	+230
+120	+48.9	+120	+248
+130	+54.4	+130	+266
+140	+60.0	+140	+284
+150	+65.6	+150	+302
+160	+71.1	+160	+320
+170	+76.7	+170	+338
+180	+82.2	+180	+356
+190	+87.8	+190	+374
+200	+93.3	+200	+392
+210	+98.9	+210	+410
+220	+104.4	+220	+428
+230	+110.0	+230	+446
+240	+115.6	+240	+464
+250	+121.1	+250	+482

Fitting Threads



BSP Threads (British Standard Pipe)

There are two types of "Pipe" profile threads:

- **Parallel (BSPP):** these threads fit in matching parallel ports. Sealing is provided by an O-ring gasket or a sealing washer.
- **Taper (BSPT):** these threads fit in matching parallel or taper ports. Sealing is provided by a pre-coating on the thread.

Thread designation

• BSP Parallel (BSPP):

G followed by the denomination, according to standard ISO 228-1.
Example: 1/8 BSP parallel thread = G1/8

• BSP Taper (BSPT):

R followed by the denomination, according to standard ISO 7-1.
Example: 1/8 BSP taper (BSPP) thread = R1/8

• Female threads:

BSP parallel: G followed by the designation
BSP taper: R followed by the designation

NPT Threads (National Pipe Thread)

This is an American standard taper thread which fits into the matching taper port. Sealing is provided by a pre-coating on the thread.
Example: 1/8 NPT thread = 1/8 NPT

Metric Threads

These ISO-profile threads are parallel and are fit into the matching parallel port. Sealing is provided by an O-ring or a sealing washer.

Thread designation

- M depending on the diameter and pitch in millimetres, separated by a multiplication sign, in accordance with standards ISO 68-1 and ISO 965-1.
Example: metric thread diameter 7 with a pitch of 1 mm = M7x1

Thread Identification

BSP Thread	Code	NPT Thread	Code
1/8	10	1/16	08
1/4	13	1/8	11
3/8	17	1/4	14
1/2	21	3/8	18
3/4	27	1/2	22
1"	34	3/4	28
1 1/4"	42	1"	35
1 1/2"	49	1 1/4"	43
2"	48	1 1/2"	50
		2"	44

Metric Thread	Code	Metric Thread	Code	Metric Thread	Code
M3x0.5	09	M12x1.25	66	M22x1.5	82
M5x0.8	19	M12x1.5	67	M24x1.5	83
M6x1	52	M13x1.25	68	M27x1.5	85
M7x1	55	M14x1.25	70	M30x2	88
M8x1	56	M14x1.5	71	M33x1.5	90
M8x1.25	57	M16x1.25	74	M39x1.5	36
M10x1	60	M16x1.5	75	M42x1.5	37
M10x1.5	62	M18x1.5	78	M42x2	96
M12x1	65	M20x1.5	80	M48x2	98

Principle and Advantages of Our Coupling Systems

A very large number of technical solutions exist for connecting two pipes together. Leader in industrial connection systems, Parker Legris offers a very wide range of technologies and materials to cover all requirements.

<p>Push-In Fittings</p> <p>Tube retention with gripping ring</p>  <p>Tube retention with collet</p>  <p>Tube retention with reversed collet</p> 	<p>Principle</p> <p>Connected and sealed simply by pushing the tube into the fitting. Disconnected by pushing on the release button.</p> <p>Tube retention with gripping ring:</p> <ul style="list-style-type: none"> • No damage to the tube • Ideal for polymer tubes • Particularly compact <p>Tube retention with collet:</p> <ul style="list-style-type: none"> • Robust solution for harsh environments • Resistant to high pressure, excellent lifespan • Ideal for grooved metal tubes <p>Tube retention with reversed collet:</p> <ul style="list-style-type: none"> • Protected disconnection • Can withstand very high pressures • Double sealing 	<p>Advantages</p> <p>Allows flexible and modular systems to be produced quickly.</p> <p>Provides a compact and lightweight connection solution.</p> <p>Facilitates installation due to a swivelling body.</p> <p>Reliability of the connection ensured through the one-piece design.</p> <p>Suitable for use with a wide range of tubes.</p> <p>Prolongs the lifespan of your systems.</p>
<p>Compression Fittings</p> 	<p>Principle</p> <p>Connection and sealing achieved by crimping a metal olive onto a tube. The seals are metal to metal.</p>	<p>Advantages</p> <p>Can withstand very high pressures and temperatures.</p> <p>Allows all types of tube to be connected, both polymer and metal.</p> <p>Increases the lifetime of the coupling.</p>
<p>Spigot Compression Fittings</p> 	<p>Principle</p> <p>Connection and sealing by the distortion and gripping of a plastic tube.</p>	<p>Advantages</p> <p>Intended for the connection of very flexible or non-calibrated tubes.</p>
<p>Couplers</p> 	<p>Principle</p> <p>A probe with an international profile connects the circuit to the coupler. Certain couplers have a safety device which enables the circuit to be vented before releasing the probe.</p>	<p>Advantages</p> <p>Suitable for frequent connection and disconnection.</p>

Product Selection Table

Push-In Fittings	Materials	Fluids	Maximum Pressure (bar)	Temperature		Performance in Aggressive Environments	
				Min.	Max.	Mechanical	Chemical
LF 3000®	Technical polymer/brass/NBR	Compressed air	20	-20°C	+80°C	Good	Moderate
LIQUIfit®	Bio-sourced polymer/EPDM	Liquids	16	-10°C	+95°C	Moderate	Good
LF 3200	Nickel-plated brass/NBR	Compressed air	20	-15°C	+80°C	Excellent	Moderate
LF 3600	Chemical nickel-plated brass FDA/FKM	All brass-compatible fluids	30	-20°C	+150°C	Excellent	Good
LF 6100	Brass/NBR	Oil, analytical gases	60	-40°C	+120°C	Excellent	Moderate
LF 3800 / LF 3900	316L - 303 stainless steel/FKM	All fluids	30	-20°C	+150°C	Excellent	Excellent

Cartridges and Customised Products

LF 3000®	Technical polymer/brass or chemical nickel-plated brass/NBR	Compressed air	20	-20°C	+80°C	Good	Moderate
LIQUIfit®	Bio-sourced polymer/EPDM	Liquids	16	-10°C	+95°C	Moderate	Good
LF 3600	Chemical nickel-plated brass FDA/FKM	All brass-compatible fluids	30	-20°C	+150°C	Excellent	Good
LF 3800 / LF 3900	316L - 303 stainless steel/FKM	All fluids	30	-20°C	+150°C	Excellent	Excellent
TL	Brass/NBR	Compressed air	16	-25°C	+80°C	Good	Moderate

Technical Tubing and Hose

Semi-Rigid PA	Semi-rigid bio-sourced polyamide	Compressed air, industrial fluids	50	-40°C	+100°C	Good	Good
Rigid PA	Rigid polyamide	Compressed air, industrial fluids	58	-40°C	+80°C	Good	Good
Fireproof High Resistance PA	Polyamide with flame-retardant additive	Coolants, industrial fluids (lubricants), compressed air	50	-40°C	+100°C	Excellent	Moderate
Anti-Spark PA and PU with or without PVC sheath	Semi-rigid polyamide with PVC sheath Polyurethane ether with PVC sheath Single-layer polyurethane ester with flame-retardant additive	Compressed air, coolants, industrial fluids	36 (PA) 14 (PU)	-20°C	+70°C +80°C	Excellent	Good
PU single and multi-tube	Polyurethane ester Polyurethane ether "Crystal" food-quality polyurethane ether	Compressed air, industrial fluids (water) or food industry fluids	12	-20°C	+70°C	Excellent	Moderate Good Good
Antistatic PU	Polyurethane filled with conductive particles	Compressed air	10	-20°C	+70°C	Excellent	Moderate
Advanced PE	Polyethylene, 50% reticulated	All fluids	16	-40°C	+95°C	Good	Excellent
FEP	Fluoropolymer: fluorinated ethylene-propylene	All fluids	28	-40°C	+150°C	Good	Excellent
PFA	Fluoropolymer: high purity and coloured perfluoroalkoxy FDA	All fluids	36	-196°C	+260°C	Excellent	Excellent
Antistatic PFA	Fluoropolymer: perfluoroalkoxy filled with conducting particles	All fluids	36	-196°C	+260°C	Excellent	Good
Self-Fastening NBR	NBR with polyamide braid	Compressed air, coolants	16	-20°C	+100°C	Excellent	Good
Braided PU	Polyurethane with polyester braid	Compressed air, industrial fluids	15	-40°C	+75°C	Excellent	Good

Function Fittings

Polymer Flow Regulators	Technical polymer/nickel-plated brass	Compressed air	10	0°C	+70°C	Good	Moderate
Metal Flow Regulators	Treated brass/nickel-plated brass	Compressed air	10	0°C	+70°C	Excellent	Moderate
Stainless Steel Flow Regulators	316L stainless steel	Compressed air	40	-15°C	+120°C	Excellent	Excellent
Blocking Fittings	Nickel-plated brass	Compressed air	10	-20°C	+70°C	Excellent	Good
Piloted Non-Return Valve	Technical polymer/nickel-plated brass	Compressed air	10	-5°C	+60°C	Good	Moderate
Non-Return Fitting	Technical polymer/nickel-plated brass	Compressed air	10	0°C	+70°C	Good	Moderate
Silencers	Polymer, sintered bronze, nickel-plated brass, 316L stainless steel	Compressed air	12	-20°C	+180°C	Good	Moderate

Compression Fittings	Materials	Fluids	Maximum Pressure (bar)	Temperature		Performance in Aggressive Environments	
				Min.	Max.	Mechanical	Chemical
Brass Fittings	Brass	Compressed air, industrial fluids	550 (depending on the type of tubing used)	-40°C	+250°C	Excellent	Good
Stainless Steel Fittings	316L stainless steel	All fluids	400 (80 bar in aggressive environment)	-40°C	+250°C	Excellent	Excellent
PL Spigot Fittings	Nickel-plated brass	Compressed air, industrial fluids	40	-40°C	+100°C	Good	Good

Industrial Valves

Universal and Customised Series Ball Valves	Nickel-plated brass	Compressed air, industrial fluids	40	-20°C	+100°C	Excellent	Good
Mini Series Ball Valves	Technical polymer/nickel-plated brass	Compressed air	10	-20°C	+80°C	Good	Moderate
DVGW Series Ball Valves	Nickel-plated brass	Gas, water	40	-40°C	+170°C	Excellent	Good
LIQUIfit® Ball Valves	Polypropylene	Drinking water, treated water, beverages	10	-15°C	+100°C	Moderate	Good
Standard Series Ball Valves	Nickel- or chromium-plated brass	All industrial fluids	30	-20°C	+130°C	Excellent	Good
Stainless Steel Series Ball Valves	316L stainless steel	All fluids	65	-20°C	+150°C	Excellent	Excellent
Axial Valves	Nickel-plated brass	Compressed air	10	-20°C	+135°C	Excellent	Good

Industrial Blowguns

Polymer	Technical polymer	Compressed air	10	-20°C	+50°C	Good	Moderate
Metal	Aluminium or nickel-plated brass	Industrial fluids	20	-20°C	+100°C	Excellent	Good

Quick-Acting Couplers

C 9000 Safety Couplers	Technical polymer	Compressed air	16	-20°C	+60°C	Good	Moderate
Metal Quick-Acting Couplers	Nickel-plated brass	Compressed air, compatible fluids	20	-20°C	+100°C	Excellent	Good
Metal Quick-Acting Couplers	316L stainless steel	Industrial fluids	35	-15°C	+200°C	Excellent	Excellent
Injection Mould Couplers	Nickel-plated brass	Water, oil	10	-15°C	+90°C	Excellent	Good

Adaptors and Manifolds

Brass Adaptors with sealing washer	Brass	Compressed air	200	-20°C	+80°C	Good	Moderate
Brass Adaptors without sealing washer	Brass	Compressed air	200	-40°C	+150°C	Good	Moderate
Nickel-Plated Brass Adaptors	Nickel-plated brass	Compressed air	60	-10°C	+80°C	Good	Moderate
Stainless Steel Adaptors	316L stainless steel	All fluids	200	-20°C	+180°C	Excellent	Excellent
Manifolds	Anodised aluminium, brass	Compressed air	20	-10°C	+80°C	Excellent	Good

This table is not exhaustive; you will find additional technical information in the various chapters of this catalogue which will enable you to select the product you need.

Part Number Identification

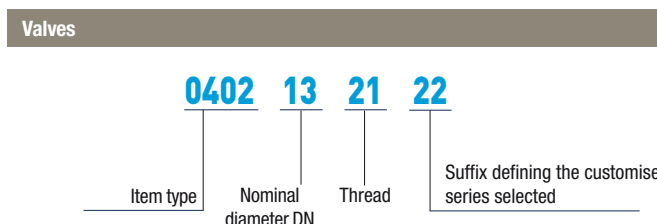
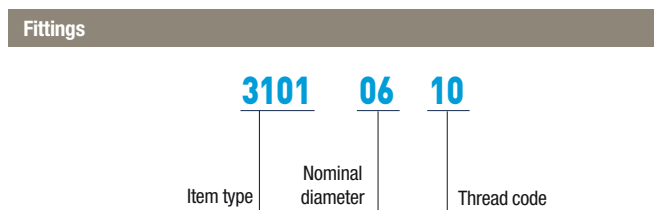
The part numbers used for our product ranges are coded in such a way as to make it easy to identify any particular item. Detailed explanations of these part numbers can be found in the corresponding chapters.

Fittings and Valves

The part numbers are selected using a technical mnemonic code.

Each fitting and valve is identified by:

- model series (4 digits)
- nominal diameter (2 digits)
- thread or 2nd nominal diameter (2 digits)
- a suffix, if applicable



Nominal diameter code: equates to the outside diameter of the tube.
Thread code: see tables page 12.

Nominal diameter code: equates to the bore diameter of the valve.
Thread code: see tables page 12.

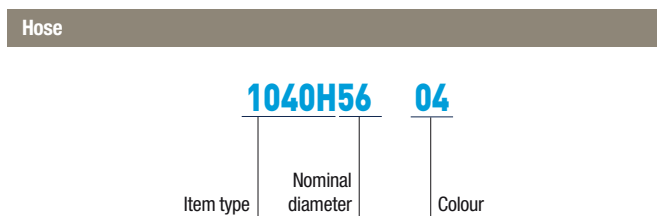
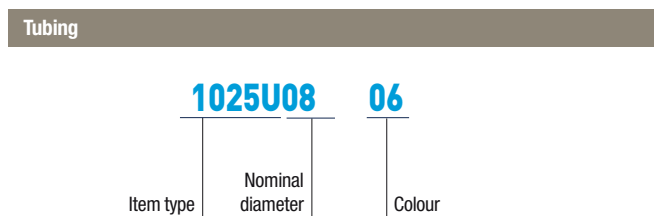
When the product does not have a thread, the code used is: 00.

Technical Tubing and Hose

The part numbers are selected using a technical mnemonic code.

Each tube and hose is identified by:

- model series (4 digits and a letter)
- nominal diameter (2 digits)
- colour (2 digits)
- inside diameter, if applicable



Nominal diameter code: equates to the outside diameter.
Colour code: see table below.

Nominal diameter code: equates to the inside diameter code.
Colour code: see table below.

00 = □ 01 = ■ 02 = ■ 03 = ■ 04 = ■ 05 = ■ 06 = ■ 07 = ■ 08 = □

For other colours, refer to chapter "Technical Tubing and Hose".

Table of Contents

Please click chapter title or chapter number

Push-In Fittings

Chapter 1

LF 3000®
LF 3200: 3 mm
LIQUIfit®
LF 3600
LF 3800/LF 3900
LF 6100



Cartridges and Customised Products

Chapter 2

Polymer: Carstick® & Quick Fitting
Metal: LF Cartridges & TL Fittings
Customised Products



Technical Tubing and Hose

Chapter 3

Flexible Calibrated Tubing
Calibrated Multi-Tubing
Recoil Tubing and Hose
Calibrated Braided Hose
Accessories



Function Fittings

Chapter 4

Flow Control Regulators
Piloted Function Fittings
Non-Return Valves & LIQUIfit®
Pressure Fittings
Other Function Fittings
Silencers



Compression Fittings

Chapter 5

Brass Compression Fittings
Stainless Steel Compression Fittings
PL Nickel-Plated Brass Spigot Fittings



Industrial Valves

Chapter 6

Ball Valves & LIQUIfit®
Needle & Butterfly Valves
Axial Valves



Industrial Blowguns

Chapter 7

Polymer
Metal
Kits



Quick-Acting Couplers

Chapter 8

Polymer: C 9000 Safety
Metal: Nickel-Plated Brass and Stainless Steel



Adaptors and Manifolds

Chapter 9

Adaptors: Brass, Nickel-Plated Brass, Stainless Steel
Manifolds



Push-In Fittings

LF 3000®

LF 3200: 3 mm

LIQUIfit®

LF 3600

LF 3800/ LF 3900

LF 6100



PARKER LEGRIS Industrial Connector Systems

Products are available from:

MARYLAND METRICS

P.O. Box 261 Owings Mills, MD 21117 USA email: sales@mdmetric.com

ph: (410)358-3130 (800)638-1830 fx: (410)358-3142 (800)872-9329

web: http://mdmetric.com RFQ form: http://mdmetric.com/rfq.htm

How to order: Please preface each PARKER LEGRIS Catalog part number with 'R053-' Example: R053-3175 04 10

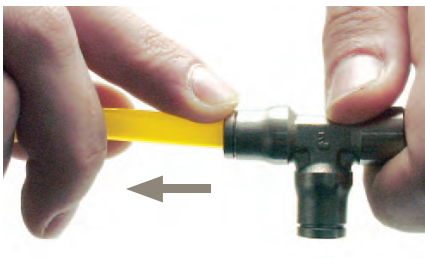
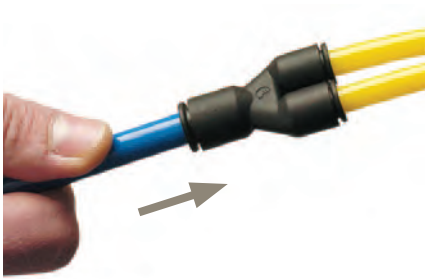


Principle and Advantages of the Push-In Fitting

The **push-in fitting** is the most intuitive way of connecting tubes to a fitting in order to create a fluid distribution network. Thanks to its **quick installation**, versatility and **exceptional lifespan**, the push-in fitting contributes to improving machine efficiency. Moreover, the advanced patented design of the LF 3000® contributes to reducing **total cost of use**.

Connection

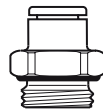
- Manual connection and disconnection without the use of tools
- Release button available in 5 colours, to identify different circuits



Assembly

All straight connectors are fitted with an internal hexagon for ease of assembly with the use of an Allen spanner. This enables assembly in restricted spaces.

Threads

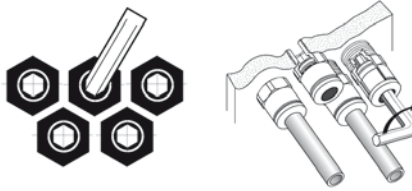


BSPP
and metric



BSPT, NPT
and NPTF

Close Porting Assembly



Our fittings are designed for internal (above) or external assembly.

Sealing and 100 % Leak-Tested

The quality of the sealing material, selected specifically for the application, ensures excellent longevity of the fitting. In this way, Parker Legris offers the best return on investment on the market.

Quality of Design

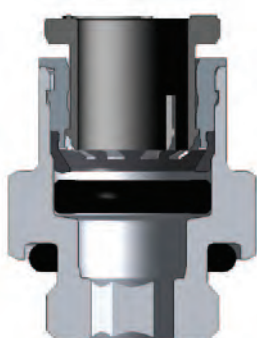
- Unique and patented sealing technology
- Rigorous selection of materials:
NBR: ideally suited for compressed air
EPDM: perfectly suited for food and beverage
FKM: all fluids and high temperatures
- 100 % leak-tested in the production process

Benefits of Use

- The lowest leak rate on the market, whatever the temperature and length of use
- Perfectly suited to primary vacuum
- Full bore for optimum flow
- Optimum gripping of tube guaranteed

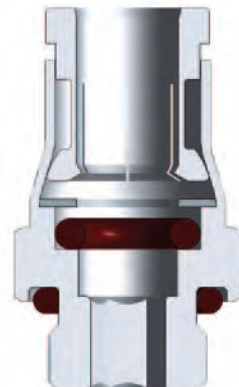
Gripping Ring Technology

- Ideal for polymer tubing, even for soft tubing
- Excellent tube guidance
- No tube movement under pressure
- Very compact solution



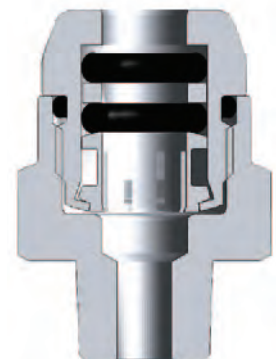
Gripping with Collet

- For polymer and grooved metal tubing (groove drawings available on request)
- Resistant to high pressure, excellent lifespan
- Robust solution for harsh environments



Gripping with Reversed Collet

- For rigid polymer and grooved metal tubing
- Resistant to high pressure
- Excellent durability
- Optimum sealing



Push-In Fittings

LF 3000® Push-In Fittings

[P. 1-4]



Fluids: compressed air

Materials: technical polymer, nickel-plated brass, NBR

Pressure: 20 bar

Temperature: -20°C to +80°C

Ø metric: 3 mm to 16 mm

Ø inch: 1/8" to 1/2"

LF 3200 3 mm Push-In Fittings

[P. 1-39]



Fluids: compressed air, non-corrosive fluids

Materials: chemical nickel-plated brass, NBR

Pressure: 20 bar

Temperature: -15°C to +80°C

Ø metric: 3 mm

LIQUIfit® Push-In Fittings

[P. 1-44]



Fluids: water, beverages, coolants, inert gases

Materials: biopolymer, EPDM

Pressure: 16 bar

Temperature: -10°C to +95°C

Ø metric: 4 mm to 12 mm

Ø inch: 5/32" to 1/2"

LF 3600 Push-In Fittings

[P. 1-65]



Fluids: compressed air, slightly corrosive industrial fluids

Materials: high phosphorus nickel-plated brass, FKM

Pressure: 30 bar

Temperature: -20°C to +150°C

Ø metric: 4 mm to 14 mm

LF 3800/LF 3900 Push-In Fittings

[P. 1-77]



Fluids: industrial fluids, chemicals, medical fluids, beverages

Materials: stainless steel, FKM

Pressure: 30 bar

Temperature: -20°C to +150°C

Ø metric: 4 mm to 12 mm

Ø inch: 3/16" to 1/2"

LF 6100 Push-In Fittings

[P. 1-89]



Fluids: compressed air, oil, water

Materials: brass, NBR

Pressure: 60 bar

Temperature: -40°C to +120°C

Ø metric: 4 mm to 10 mm

For more details on these ranges, you will find a selection guide in the "Introduction" section of this catalogue.

LF 3000® Push-In Fittings Range

Stud Fittings									
Straights				Straights - Inch					
3175 BSPT/NPT Page 1-7	3101 BSPP/Metric Page 1-8	3181 Metric Page 1-8	3114 BSPP/Metric Page 1-9	3121 BSPT/NPT Page 1-9	3131 BSPP/Metric Page 1-10	3175 NPT/BSPT Page 1-7/8	3121 NPT Page 1-9		
Elbows				Elbows - Inch					
3109 BSPT/NPT Page 1-10	3199 BSPP/Metric Page 1-11	3192 BSPP Page 1-12	3129 BSPT Page 1-12	3169 BSPP/Metric Page 1-13	3113 BSPT Page 1-13	3133 BSPP/Metric Page 1-13	3109 NPT/BSPT Page 1-11		
Tees			Y		Cartridge		Cartridge - Inch		
3108 BSPT Page 1-14	3198 BSPP/Metric Page 1-14	3103 BSPT Page 1-14	3193 BSPP/Metric Page 1-15	3148 BSPT Page 1-15	3158 BSPP/Metric Page 1-15	3112 BSPT Page 1-16	3132 BSPP Page 1-16	3100 Carstick® Page 1-16	3100 Carstick® Page 1-16

Tube-to-Tube Fittings															
Straight		Straight - Inch		Elbow		Elbow - Inch		Tee		Tee - Inch		Y		Cross	
3106 Page 1-17		3106 Page 1-17		3102 Page 1-17		3102 Page 1-17		3104 Page 1-18		3104 Page 1-18		3140 Page 1-18		3107 Page 1-19	

Bulkhead Connector Fittings			
Straights			Elbow
3116 Page 1-20	3146 Page 1-20	3136 Page 1-20	3139 Page 1-20

Multiple Fittings			
Y	Tee	Elbow	Manifold
3144 Page 1-21	3304 Page 1-21	3306 Page 1-21	3310 Page 1-21

LF 3000® Push-In Fittings Range

LF 3000®

Push-In Fittings

Plug-In Fittings and Accessories

Elbows

3182
Page 1-22

3184
Page 1-22

3180
Page 1-22

Tees

3183
Page 1-23

3188
Page 1-23

Y

3142
Page 1-23

3143
Page 1-23

Elbows - Inch

3182
Page 1-22



Accessories

3120
Page 1-24

3166
Page 1-24

3168
Page 1-24

3126
Page 1-25

3122
Page 1-25

3151
Page 1-25

Accessories - Inch

3166
Page 1-24

3168
Page 1-24

3126
Page 1-25



Banjo Fittings

Banjo Fittings

3118
BSPP/Metric
Page 1-27

3018
BSPT
Page 1-27

3124
BSPP/Metric
Page 1-27

3149
BSPP/Metric
Page 1-27

3119
BSPP/Metric
Page 1-27



Modular Banjo Fittings

3538
Single Body
Page 1-28

3539
Double Body
Page 1-28

3549
Y Body
Page 1-28

3527
BSPP/Metric
Page 1-29

3528
BSPP/Metric
Page 1-29

3529
BSPP
Page 1-29

3524
BSPP/Metric
Page 1-29



Multi-Connectors

3300
Page 1-31

3320
Page 1-31

3321
Page 1-31

3329
Page 1-31

3379
Page 1-32

3381
Page 1-32



Self-Sealing and Oscillating Fittings

Self-Sealing Fittings

3391
BSPP
Page 1-35

3091
BSPT
Page 1-35

3160
Page 1-35

Oscillating Fittings

3159
BSPT
Page 1-35

3189
BSPP/Metric
Page 1-35



Accessories for Push-In Fittings

3130
Page 1-37

Clip
Page 1-37

3000 70
Page 1-37

3110
Page 1-37

0178
BSPP/Metric
Page 1-37

0222
BSPP/Metric
Page 1-37



LF 3000® Push-In Fittings

The LF 3000® range, with its wide variety of shapes and configurations, allows you to find **the perfect product to meet your needs** and thus **optimise the use** of your equipment.

Product Advantages

World-Class Performance

- 40 years of expertise
- Full bore for optimum flow
- Ideal for vacuum or pressure applications
- Automatic sealing guaranteed, in both static and dynamic applications
- Materials with high resistance
- Durability of product and equipment

Optimal Design

- 100% leak-tested in production
- Date coding to guarantee quality and traceability
- Compact and aesthetic design: reduced dimensions for space-saving
- Tube fixed during connection, preventing leakage
- Conforms to ISO 14743
- Excellent vacuum performance thanks to the patented sealing technology
- Lightweight: reduced energy consumption of operating systems
- Parallel threaded fitting with a patented captive O-ring seal
- Maximum flexibility due to the wide product range



Applications

- Robotics
- Automotive Process
- Pneumatics
- Semi-Conductors
- Textile
- Packaging
- Vacuum

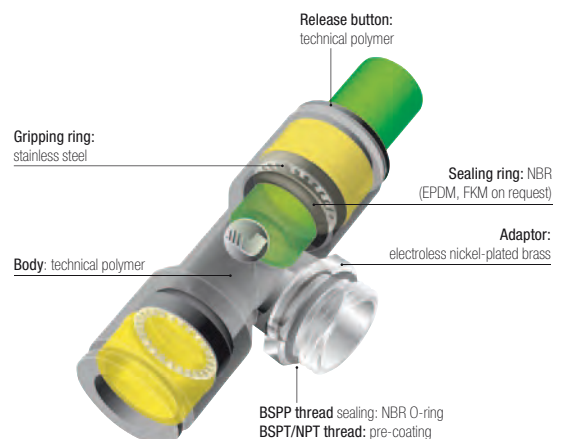
Technical Characteristics

Compatible Fluids	Compressed air Other fluids: please consult us
Working Pressure	Vacuum to 20 bar
Working Temperature	-20°C to +80°C

Tightening Torque (daN.m)	Threads								
	M3 x0.5	M5 x0.8	M7 x1	M10 x1	M12 x1.5	G1/8	G1/4	G3/8	G1/2
	0.06	0.16	0.8	0.8	1.1	0.8	1.2	3	3.5

Reliable performance is dependent upon the type of fluid conveyed, component materials and tubing being used.
Use is guaranteed with a vacuum of 755 mm Hg (99% vacuum).

Component Materials




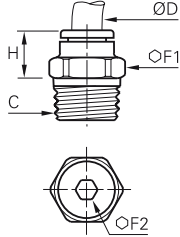

Silicone-free

Regulations

ISO 14743: Pneumatic fluid power, push-in connectors for thermoplastic tubes
 DI: 97/23/EC (PED)
 DI: 2002/95/EC (RoHS), 2011/65/EC
 DI: 1907/2006 (REACH)


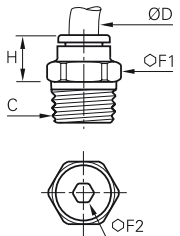

Stud Fittings

3175 Stud Fitting, Male BSPT Thread

	Nickel-plated brass, NBR 	ØD	C		F1	F2	H	kg
		4	R1/8	3175 04 10	10	3	9.5	0.005
		4	R1/4	3175 04 13	14	3	6.5	0.012
			R3/8	3175 04 17	17	3	8	0.024
			R1/8	3175 06 10	10	4	11.5	0.005
		6	R1/4	3175 06 13	14	4	8.5	0.011
			R3/8	3175 06 17	17	4	8.5	0.022
			R1/2	3175 06 21	21	4	9	0.043
		8	R1/8	3175 08 10	13	5	20	0.011
			R1/4	3175 08 13	14	6	17	0.014
			R3/8	3175 08 17	17	6	13	0.021
		10	R1/2	3175 08 21	21	6	12	0.040
			R1/8	3175 10 10	16	5	22.5	0.017
			R1/4	3175 10 13	16	7	20	0.017
		12	R3/8	3175 10 17	17	8	16.5	0.019
			R1/2	3175 10 21	21	8	14	0.037
			R1/4	3175 12 13	19	7	26.5	0.029
		14	R3/8	3175 12 17	19	9	24	0.028
			R1/2	3175 12 21	21	10	19.5	0.036
			R3/8	3175 14 17	22	9	28.5	0.043
16	R1/2	3175 14 21	24	10	23.5	0.047		
	R3/8	3175 16 17	27	9	32.5	0.068		
	R1/2	3175 16 21	27	12	32.5	0.079		

Pre-coated thread


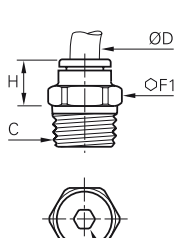

3175 Stud Fitting, Male NPT Thread

	Nickel-plated brass, NBR 	ØD	C		F1	F2	H	kg
		6	NPT1/8	3175 06 11	11	4	11.5	0.006
		6	NPT1/4	3175 06 14	14	4	8.5	0.012
			NPT1/4	3175 10 14	16	7	20	0.018
		10	NPT3/8	3175 10 18	18	8	16.5	0.023
			NPT1/2	3175 10 22	22	8	14	0.037
		12	NPT3/8	3175 12 18	19	9	24	0.030
			NPT1/2	3175 12 22	22	10	19.5	0.037

Pre-coated thread

3175 Stud Fitting, Male NPT Thread

Inch

	Nickel-plated brass, NBR 	ØD	C		F1	F2	H	kg
		1/8	NPT1/8	3175 53 11	11	2	7.2	0.006
			NPT1/4	3175 53 14	14	2	8	0.016
		1/4	NPT1/8	3175 56 11	11	4	11.9	0.006
			NPT1/4	3175 56 14	14	4	9.4	0.013
			NPT3/8	3175 56 18	18	5	7.6	0.024
		3/8	NPT1/8	3175 60 11	16	4	22.7	0.019
			NPT1/4	3175 60 14	16	7	20.5	0.019
		1/2	NPT3/8	3175 60 18	18	7	17.5	0.026
			NPT3/8	3175 62 18	22	9.5	25.9	0.047
			NPT1/2	3175 62 22	24	9.5	22.1	0.064


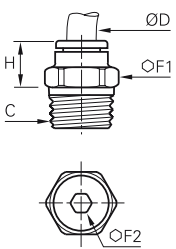

Pre-coated thread

Other products are available upon request; please do not hesitate to consult us.


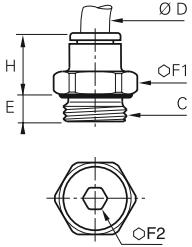

Stud Fittings

3175 Stud Fitting, Male BSPT Thread


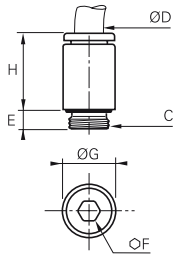

Inch

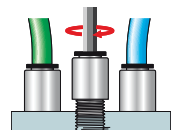
	Nickel-plated brass, NBR		ØD	C		F1	F2	H	kg
			Pre-coated thread						
			1/8	R1/8	3175 53 10	11	3	8.5	0.005
			3/16	R1/8	3175 55 10	11.1	3.2	15.5	0.009
			3/16	R1/4	3175 55 13	14.3	4	15	0.020
			1/4	R1/8	3175 56 10	11	4	12	0.006
			1/4	R1/4	3175 56 13	14	4	9.5	0.021
			3/8	R1/4	3175 60 13	18	5	7.5	0.017
			3/8	R3/8	3175 60 17	13	5	20	0.019
			1/2	R1/2	3175 60 21	14	6	16.8	0.061
			1/2	R1/4	3175 62 13	22	6	26.9	0.044
			1/2	R3/8	3175 62 17	22	7	25.9	0.048
			1/2	R1/2	3175 62 21	24	7	20.5	0.049

3101 Stud Fitting, Male BSPP and Metric Thread

	Nickel-plated brass, NBR		ØD	C		E	F1	F2	H	kg
			* Bi-material O ring seal							
			3	M3x0.5	3101 03 09*	2.5	8	-	12.5	0.003
			3	M5x0.8	3101 03 19	3.5	8	2.5	12.5	0.004
			3	M3x0.5	3101 04 09*	2.5	8	-	14.5	0.003
			3	M5x0.8	3101 04 19	3	9	2.5	14	0.003
			4	M7x1	3101 04 55	5	10	2.5	14	0.004
			4	G1/8	3101 04 10	5	13	3	11.5	0.007
			4	G1/4	3101 04 13	5.5	16	3	10.5	0.011
			4	M5x0.8	3101 06 19	3	11	2.5	16	0.005
			4	M7x1	3101 06 55	5	10	3	16	0.006
			4	M10x1	3101 06 60	5	13	4	13	0.007
			4	M12x1.5	3101 06 67	5.5	15	4	13	0.009
			4	G1/8	3101 06 10	5	13	4	13	0.007
			4	G1/4	3101 06 13	5.5	16	4	12.5	0.011
			4	G3/8	3101 06 17	5.5	20	4	13	0.020
			4	G1/2	3101 06 21	7.5	24	4	20	0.040
			4	M10x1	3101 08 60	5	13	5	21	0.011
			4	M12x1.5	3101 08 67	5.5	15	5	21	0.015
			4	G1/8	3101 08 10	4.5	13	5	20.5	0.011
			4	G1/4	3101 08 13	5.5	16	6	19.5	0.016
			4	G3/8	3101 08 17	5.5	20	6	18	0.022
			4	G1/2	3101 08 21	7.5	24	6	16.5	0.039
			4	G1/4	3101 10 13	5.5	16	7	23	0.018
			4	G3/8	3101 10 17	5.5	20	8	19.5	0.021
			4	G1/2	3101 10 21	7.5	24	8	18.5	0.033
			4	G1/4	3101 12 13	5.5	19	7	27.5	0.027
			4	G3/8	3101 12 17	5.5	20	9	27	0.029
			4	G1/2	3101 12 21	7	24	11	22.5	0.035
			4	G3/8	3101 14 17	5.5	22	9	29.5	0.041
			4	G1/2	3101 14 21	7	24	11	28	0.047
			4	G3/8	3101 16 17	7.5	27	9	32.5	0.061
			4	G1/2	3101 16 21	9	27	12	32.5	0.066


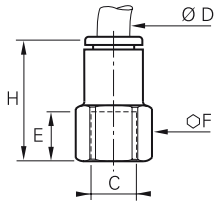

3181 Stud Fitting Round Body, Male Metric Thread

	Nickel-plated brass, NBR		ØD	C		E	F	G	H	kg
			The internal hexagon and circular external shape ensure that model 3181 provides highly compact assembly. They can be easily installed with an Allen key without the need of a spanner.							
			4	M5x0.8	3181 04 19	3.5	2.5	8.5	14.5	0.005
			4	M7x1	3181 04 55	5	3	10	14	0.004
			6	M5x0.8	3181 06 19	3.5	2.5	11	16	0.007
			6	M7x1	3181 06 55	5	3	10	16	0.005


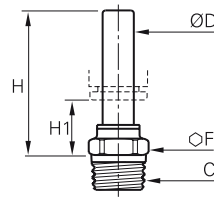



Stud Fittings

3114 Stud Fitting, Female BSPP and Metric Thread


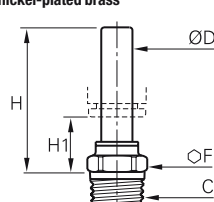

	Nickel-plated brass, NBR		ØD	C		E	F	H	kg
			4	M5x0.8	3114 04 19	6.5	8	19.5	0.005
				G1/8	3114 04 10	9.5	13	22.5	0.010
			6	G1/4	3114 04 13	13.5	16	26.5	0.015
				G1/8	3114 06 10	9.5	13	24.5	0.011
			8	G1/4	3114 06 13	13.5	16	28.5	0.017
				G1/8	3114 08 10	9.5	13	29	0.015
				G1/4	3114 08 13	13.5	16	33	0.021
			10	G3/8	3114 08 17	14	19	34	0.025
				G1/4	3114 10 13	13.5	16	36	0.027
				G3/8	3114 10 17	14	19	36	0.027
			12	G1/2	3114 10 21	19.5	24	41.5	0.048
				G3/8	3114 12 17	14	19	40	0.033
			14	G1/2	3114 12 21	19.5	24	45.5	0.052
				G3/8	3114 14 17	14	22	42.5	0.057
			16	G1/2	3114 16 21	15	27	49	0.096

3121 Stud Standpipe, Male BSPT Thread

	Technical polymer, nickel-plated brass		ØD	C		F	H	H1	kg
			4	R1/8	3121 04 10	10	26	14	0.005
				R1/4	3121 04 13	14	26.5	14.5	0.014
			6	R1/8	3121 06 10	10	28	14	0.005
				R1/4	3121 06 13	14	28.5	14.5	0.014
			8	R1/8	3121 08 10	10	29.5	11	0.006
				R1/4	3121 08 13	14	28.5	10	0.012
				R3/8	3121 08 17	17	28.5	10	0.015
			10	R1/4	3121 10 13	15	36	15.5	0.012
				R3/8	3121 10 17	17	36	15.5	0.017
				R1/2	3121 10 21	21	36	15.5	0.028
			12	R3/8	3121 12 17	17	36.5	12	0.018
				R1/2	3121 12 21	21	36.5	12	0.028
			14	R1/2	3121 14 21	21	41	13.5	0.042

Pre-coated thread


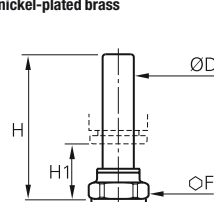

3121 Stud Standpipe, Male NPT Thread

	Technical polymer, nickel-plated brass		ØD	C		F	H	H1	kg
			4	NPT1/8	3121 04 11	11	25.9	14.5	0.007
				NPT1/4	3121 04 14	14	26.4	15	0.017
			8	NPT1/8	3121 08 11	11	29.5	10.9	0.008
				NPT1/4	3121 08 14	14	28.4	9.9	0.014

Pre-coated thread
5/32" (4 mm) and 5/16" (8 mm) are also available

3121 Stud Standpipe, Male NPT Thread


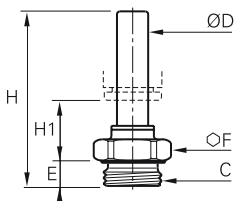

Inch

	Technical polymer, nickel-plated brass		ØD	C		F	H	H1	kg
			1/4	NPT1/8	3121 56 11	11	30	15.5	0.001
				NPT1/4	3121 56 14	14	28.4	14.5	0.001
			3/8	NPT1/8	3121 60 11	15	44.4	16.5	0.013
				NPT1/4	3121 60 14	15	36.1	17	0.014
				NPT3/8	3121 60 18	18	36.1	15.5	0.023
			1/2	NPT3/8	3121 62 18	17	36.6	9.4	0.026
				NPT1/2	3121 62 22	21	37.1	9.9	0.046


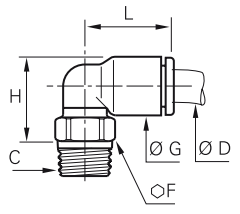

Pre-coated thread
5/32" (4 mm) and 5/16" (8 mm) are also available

Stud Fittings

3131 Stud Standpipe, Male BSPP and Metric Thread


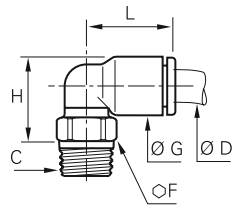

	Technical polymer, nickel-plated brass, NBR 	ØD	C		E	F	H	H1	kg		
		4	M5x0.8 G1/8 G1/4	3131 04 19 3131 04 10 3131 04 13		3.5 5 5.5	8 13 16	31 30 31	16 13.5 13.5	0.002 0.005 0.010	
		6	G1/8 G1/4	3131 06 10 3131 06 13		5 5.5	13 16	32 33	13.5 13.5	0.005 0.010	
		8	G1/8 G1/4 G3/8	3131 08 10 3131 08 13 3131 08 17		5 5.5 5.5	13 16 20	35.5 34.5 34.5	12.5 10.5 10.5	0.008 0.010 0.015	
			10	G1/4 G3/8 G1/2	3131 10 13 3131 10 17 3131 10 21		5.5 5.5 7.5	16 20 24	43.5 41.5 41.5	17.5 15.5 15.5	0.012 0.015 0.024
				12	G3/8 G1/2	3131 12 17 3131 12 21		5.5 7	20 24	42 43.5	12 12
		14	G3/8 G1/2		3131 14 17 3131 14 21		5.5 7	20 24	46.5 48	14 13.5	0.018 0.025

3109 Stud Elbow, Male BSPT Thread

	Technical polymer, nickel-plated brass, NBR 	ØD	C		F	G	H	L	kg		
		4	R1/8 R1/4 R3/8	3109 04 10 3109 04 13 3109 04 17		10 14 17	8.5 8.5	13.5 14	14 14	0.006 0.015 0.018	
		6	R1/8 R1/4 R3/8	3109 06 10 3109 06 13 3109 06 17		10 14 17	10.5 10.5	15.5 16	16 16	0.006 0.015 0.019	
		8	R1/2 R1/8 R1/4 R3/8	3109 06 21 3109 08 10 3109 08 13 3109 08 17		21 10 14 17	10.5 13.5	16.5 18	16 23	0.034 0.007 0.014 0.018	
			10	R1/2 R1/8 R1/4 R3/8	3109 08 21 3109 10 10 3109 10 13 3109 10 17		21 15 15 17	10.5 16	19.5 22	23 26.5	0.033 0.012 0.014 0.019
				12	R1/2 R3/8	3109 10 21 3109 12 13 3109 12 17		21 15 17	16 19	22 25	26.5 31
		14	R1/2 R3/8		3109 12 21 3109 14 17		21 20	19 22	25 30.5	31 35.5	0.033 0.031
			16	R1/2 R3/8	3109 14 21 3109 16 17		24 27	22 27	28.5 53	35.5 39	0.041 0.106

Pre-coated thread
The body swivels for positioning purposes.

3109 Stud Elbow, Male NPT Thread


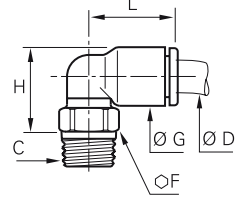

	Technical polymer, nickel-plated brass, NBR 	ØD	C		F	G	H	L	kg	
		4	NPT1/8 NPT1/4	3109 04 11 3109 04 14		11 14	8.4	13.5 14	14 14	0.007 0.016
		6	NPT1/8 NPT1/4	3109 06 11 3109 06 14		11 14	10.5	15.5 16	16 16	0.007 0.017
		8	NPT1/8 NPT1/4	3109 08 11 3109 08 14		11 14	13.5	19	23.1	0.009 0.015
			10	NPT1/4 NPT3/8	3109 10 14 3109 10 18		15 18	16	23	26.5
		12		NPT1/2 NPT3/8	3109 10 22 3109 12 18		22 18	16	23	26.5
			12	NPT1/2	3109 12 22		22	19	26	31

Pre-coated thread
The body swivels for positioning purposes.

Stud Fittings

3109 Stud Elbow, Male NPT Thread


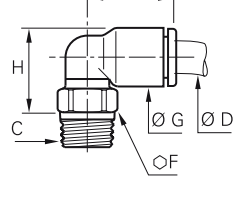

Inch

	Technical polymer, nickel-plated brass, NBR 	ØD	C		F	G	H	L	kg
		1/8	NPT1/8	3109 53 11	11	8.5	13.5	14.5	0.007
		NPT1/4	3109 53 14	14	8.5	14	14.5	0.015	
		NPT1/8	3109 56 11	11	10.9	17	18	0.007	
		NPT1/4	3109 56 14	14	10.9	16	18	0.014	
		NPT3/8	3109 56 18	18	10.9	16.5	18	0.021	
		NPT1/8	3109 60 11	15	16	23.1	27.4	0.014	
		NPT1/4	3109 60 14	15	16	23.1	27.4	0.017	
		NPT3/8	3109 60 18	18	16	22.1	27.4	0.023	
		NPT3/8	3109 62 18	20	22.1	31	35.1	0.041	
		NPT1/2	3109 62 22	24	22.1	28.4	35.1	0.054	

Pre-coated thread - 5/32" (4 mm) and 5/16" (8 mm) are also available.
The body swivels for positioning purposes.


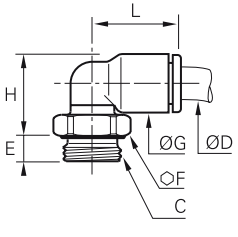

3109 Stud Elbow, Male BSPT Thread

Inch

	Technical polymer, nickel-plated brass, NBR 	ØD	C		F	G	H	L	kg
		1/8	R1/8	3109 53 10	10	8.5	13.5	14.5	0.011
		R1/8	3109 55 10	11	10.9	17	21.6	0.010	
		R1/4	3109 55 13	14	8.4	14	14	0.016	
		R1/8	3109 56 10	10	10.9	17	18	0.006	
		R1/4	3109 56 13	14	10.9	17	18	0.013	
		R1/4	3109 60 13	15	16	22.1	26.4	0.016	
		R3/8	3109 60 17	17	16	22.1	26.4	0.054	
		R1/4	3109 62 13	20	22.1	31	35.1	0.064	
		R3/8	3109 62 17	20	22.1	31	35.1	0.067	
		R1/2	3109 62 21	24	22.1	28.4	35.1	0.046	

Pre-coated thread
The body swivels for positioning purposes.
5/32" (4 mm) and 5/16" (8 mm) are also available.


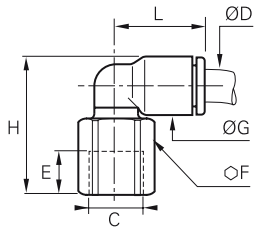

3199 Stud Elbow, Male BSPP and Metric Thread

	Technical polymer, nickel-plated brass, NBR 	ØD	C		E	F	G	H	L	kg
		3	M3x0.5	3199 03 09*	2.5	8	8.5	15	14.5	0.003
	M5x0.8	3199 03 19	3.5	8	8.5	13.5	14.5	0.003		
	M3x0.5	3199 04 09*	2.5	8	8.5	15	14.5	0.002		
	M5x0.8	3199 04 19	3.5	8	8.5	13.5	14	0.002		
	M7x1	3199 04 55	4.5	10	8.5	15	14	0.005		
	G1/8	3199 04 10	5	13	8.5	13	14	0.006		
	G1/4	3199 04 13	5.5	16	8.5	13	14	0.011		
	M5x0.8	3199 06 19	3.5	8	10.5	15.5	16	0.003		
	M7x1	3199 06 55	4.5	10	10.5	17.5	16	0.006		
	M10x1	3199 06 60	5	13	10.5	15	14	0.006		
	M12x1.5	3199 06 67	5.5	15	10.5	15	16	0.009		
	G1/8	3199 06 10	5	13	10.5	15	16	0.006		
	G1/4	3199 06 13	5.5	16	10.5	15	16	0.011		
	G3/8	3199 06 17	5.5	20	10.5	15.5	16	0.022		
	G1/2	3199 06 21	7	24	10.5	16	16	0.027		
	M10x1	3199 08 60	5	13	13.5	20.5	23	0.009		
	M12x1.5	3199 08 67	5.5	15	13.5	19.5	23	0.009		
	G1/8	3199 08 10	4.5	13	13.5	20.5	23	0.009		
	G1/4	3199 08 13	5.5	16	13.5	18.5	23	0.012		
	G3/8	3199 08 17	5.5	20	13.5	18.5	23	0.017		
	G1/2	3199 08 21	7	24	13.5	19	23	0.027		
	G1/4	3199 10 13	5.5	16	16	23.5	26.5	0.014		
	G3/8	3199 10 17	5.5	20	16	22	26.5	0.017		
	G1/2	3199 10 21	7.5	24	16	22	26.5	0.026		
	G1/4	3199 12 13	5.5	16	19	26.5	31	0.016		
	G3/8	3199 12 17	5.5	20	19	25	31	0.019		
	G1/2	3199 12 21	7	24	19	25	31	0.029		
	G3/8	3199 14 17	5.5	20	22	32.5	35.5	0.029		
	G1/2	3199 14 21	7	24	22	27	35.5	0.028		
	G3/8	3199 16 17	7.5	27	27	54.5	39	0.101		
	G1/2	3199 16 21	9	27	27	54.5	39	0.097		

The body swivels for positioning purposes.
*Bi-material seal


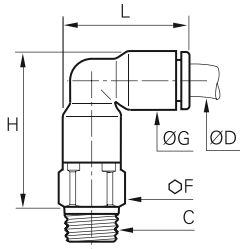

Stud Fittings

3192 Stud Elbow, Female BSPP Thread

		Technical polymer, nickel-plated brass, NBR	ØD	C		E	F	G	H	L	kg
			4	G1/8	3192 04 10	8.5	13	8.5	23	14	0.010
				G1/4	3192 04 13	11.5	16	8.5	27	14	0.017
			6	G1/8	3192 06 10	8.5	13	10.5	25	16	0.010
				G1/4	3192 06 13	11.5	16	10.5	29	16	0.017
			8	G1/8	3192 08 10	8.5	13	13.5	28	23	0.012
				G1/4	3192 08 13	11.5	16	13.5	32	23	0.020
				G3/8	3192 08 17	12	19	13.5	33	23	0.026
				G1/4	3192 10 13	11	16	16	34.5	26.5	0.020
			10	G3/8	3192 10 17	12	19	16	35	26.5	0.025
				G1/2	3192 10 21	16	24	16	41	26.5	0.049
				G1/4	3192 12 13	11	16	19	38	30.5	0.023
			12	G3/8	3192 12 17	12	19	19	38.5	30.5	0.027
				G1/2	3192 12 21	16	24	19	43.5	30.5	0.050

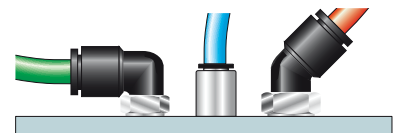
The body swivels for positioning purposes.

3129 Extended Stud Elbow, Male BSPT Thread

		Technical polymer, nickel-plated brass, NBR	ØD	C		F	G	H	L	kg
			4	R1/8	3129 04 10	10	8.5	23	19	0.008
				R1/4	3129 04 13	14	8.5	23.5	19	0.018
			6	R1/8	3129 06 10	10	10.5	27	22.5	0.010
				R1/4	3129 06 13	14	10.5	27.5	22.5	0.020
			8	R1/8	3129 08 10	13	13.5	34.5	29.5	0.018
				R1/4	3129 08 13	14	13.5	32.5	29.5	0.022
				R3/8	3129 08 17	17	13.5	33	29.5	0.032
				R1/4	3129 10 13	15	16	39.5	34.5	0.031
			10	R3/8	3129 10 17	17	16	39.5	34.5	0.041
				R1/2	3129 10 21	21	16	39.5	34.5	0.060
				R1/4	3129 12 13	19	19	45.5	40.5	0.035
			12	R3/8	3129 12 17	19	19	45.5	40.5	0.051
				R1/2	3129 12 21	21	19	45.5	40.5	0.065
				R3/8	3129 14 17	21	22	51.5	46.5	0.064
			14	R1/2	3129 14 21	21	22	51.5	46.5	0.070


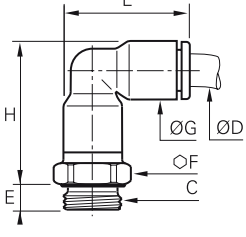

Pre-coated thread
The body swivels for positioning purposes.

Parker Legris offers the solution to enable many types of configuration options.




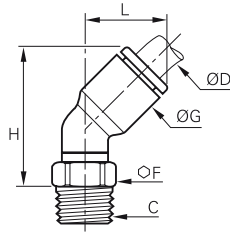

Stud Fittings

3169 Extended Stud Elbow, Male BSPP and Metric Thread

 <p>Technical polymer, nickel-plated brass, NBR</p> 	<p>Technical polymer, nickel-plated brass, NBR</p>	ØD	C		E	F	G	H	L	kg
		4	M5x0.8	3169 04 19	3.5	8	8.5	23	19	0.005
			M7x1	3169 04 55	4.5	10	8.5	22.5	19	0.008
			G1/8	3169 04 10	5	13	8.5	22.5	19	0.009
			G1/4	3169 04 13	5.5	16	8.5	22.5	19	0.014
		6	M5x0.8	3169 06 19	3.5	10	10.5	27.5	23	0.008
			M7x1	3169 06 55	4.5	10	10.5	26	23	0.012
			G1/8	3169 06 10	5	13	10.5	27	23	0.011
			G1/4	3169 06 13	5.5	16	10.5	27	23	0.016
		8	G1/8	3169 08 10	5	13	13.5	36	29.5	0.018
			G1/4	3169 08 13	5.5	16	13.5	33	29.5	0.020
			G3/8	3169 08 17	5.5	20	13.5	33	29.5	0.028
		10	G1/4	3169 10 13	5.5	16	16	40.5	34.5	0.029
			G3/8	3169 10 17	5.5	20	16	40.5	34.5	0.037
			G1/2	3169 10 21	7.5	24	16	40.5	34.5	0.042
		12	G1/4	3169 12 13	5.5	19	19	44.5	40.5	0.049
			G3/8	3169 12 17	5.5	20	19	42	40.5	0.040
			G1/2	3169 12 21	7.5	24	19	42	40.5	0.049
		14	G3/8	3169 14 17	5.5	22	22	51	46.5	0.059
			G1/2	3169 14 21	7.5	24	22	48.5	46.5	0.063
16	G3/8	3169 16 17	7.5	27	27	82.5	52	0.220		
	G1/2	3169 16 21	9	27	27	82.5	52	0.206		


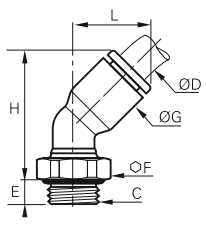

The body swivels for positioning purposes.

3113 45° Elbow, Male BSPT Thread

 <p>Technical polymer, nickel-plated brass, NBR</p> 	<p>Technical polymer, nickel-plated brass, NBR</p>	ØD	C		F	G	H	L	kg
		4	R1/8	3113 04 10	10	9	21	13	0.006
		6	R1/8	3113 06 10	10	11	24.5	14.5	0.006
			R1/4	3113 06 13	14	11	25	14.5	0.015
		8	R1/8	3113 08 10	10	13.5	30	19.5	0.008
			R3/8	3113 08 17	17	13.5	28.5	19.5	0.020
		10	R1/4	3113 10 13	15	16	33.5	23	0.014
			R3/8	3113 10 17	17	16	33.5	23	0.019
			R1/2	3113 10 21	21	16	34	23	0.100
		12	R1/4	3113 12 13	15	19	39	26	0.016
			R3/8	3113 12 17	17	19	39	26	0.022
			R1/2	3113 12 21	21	19	39	26	0.040

Pre-coated thread
The body swivels for positioning purposes.
This model prevents distortion of the tube.


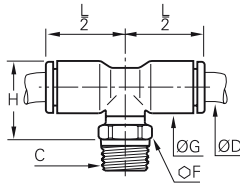

3133 45° Elbow, Male BSPP and Metric Thread

 <p>Technical polymer, nickel-plated brass, NBR</p> 	<p>Technical polymer, nickel-plated brass, NBR</p>	ØD	C		E	F	G	H	L	kg
		4	M5x0.8	3133 04 19	3.5	8	9	23	13	0.003
			G1/8	3133 04 10	4.5	13	9	20.5	13	0.006
		6	M5x0.8	3133 06 19	3.5	8	11	28	14.5	0.003
			G1/8	3133 06 10	4.5	13	11	24	14.5	0.006
			G1/4	3133 06 13	5.5	16	11	24	14.5	0.011
		8	G1/8	3133 08 10	4.5	13	13.5	31	19.5	0.011
			G1/4	3133 08 13	5.5	16	13.5	29	19.5	0.012
			G3/8	3133 08 17	5.5	20	13.5	29	19.5	0.020
		10	G1/4	3133 10 13	5.5	16	16	35	23	0.014
			G3/8	3133 10 17	5.5	20	16	33.5	23	0.017
			G1/2	3133 10 21	7	24	16	33.5	23	0.026
		12	G1/4	3133 12 13	5.5	16	19	40.5	26	0.016
			G3/8	3133 12 17	5.5	20	19	39	26	0.019
			G1/2	3133 12 21	7	24	19	39	26	0.028

The body swivels for positioning purposes.
This model prevents distortion of the tube.


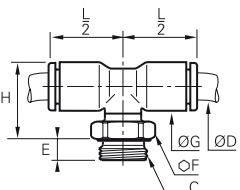

Stud Fittings

3108 Stud Branch Tee, Male BSPT Thread

	Technical polymer, nickel-plated brass, NBR			ØD	C		F	G	H	L/2	kg
	4	R1/8		3108 04 10	10	8.5	15.5	14	0.006		
	R1/4	3108 04 13	14	8.5	16	14	0.015				
	6	R1/8	3108 06 10	10	10.5	17.5	16	0.007			
	R1/4	3108 06 13	14	10.5	18	16	0.016				
	8	R1/8	3108 08 10	10	13.5	22	23	0.009			
	R1/4	3108 08 13	14	13.5	21	23	0.016				
	R3/8	3108 08 17	17	13.5	21	23	0.020				
	R1/4	3108 10 13	15	16	24	26.5	0.017				
	10	R3/8	3108 10 17	17	16	24	26.5	0.022			
	R1/2	3108 10 21	21	16	24	26.5	0.033				
	12	R1/4	3108 12 13	15	19	27	31	0.021			
	R3/8	3108 12 17	17	19	27	31	0.026				
	R1/2	3108 12 21	21	19	27	31	0.037				
	14	R3/8	3108 14 17	20	22	30.5	35	0.038			
	R1/2	3108 14 21	24	22	28.5	35	0.048				
	16	R3/8	3108 16 17	27	27	53	38.5	0.128			
	R1/2	3108 16 21	27	27	53	38.5	0.124				


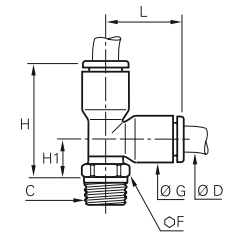

Pre-coated thread
The body swivels for positioning purposes.

3198 Stud Branch Tee, Male BSPP and Metric Thread

	Technical polymer, nickel-plated brass, NBR			ØD	C		E	F	G	H	L/2	kg
	4	M5x0.8		3198 04 19	3.5	8	8.5	17.5	14	0.003		
	G1/8	3198 04 10	5	13	8.5	15	14	0.006				
	G1/4	3198 04 13	5.5	16	8.5	15	14	0.011				
	6	M5x0.8	3198 06 19	3.5	8	10.5	19.5	16	0.004			
	G1/8	3198 06 10	5	13	10.5	17	16	0.007				
	G1/4	3198 06 13	5.5	16	10.5	17	16	0.012				
	8	G1/8	3198 08 10	4.5	13	13.5	23.5	23	0.011			
	G1/4	3198 08 13	5.5	16	13.5	21.5	23	0.014				
	G3/8	3198 08 17	5.5	20	13.5	21.5	23	0.019				
	10	G1/4	3198 10 13	5.5	16	16	26	26.5	0.017			
	G3/8	3198 10 17	5.5	20	16	24	26.5	0.020				
	G1/2	3198 10 21	7.5	24	16	24	26.5	0.029				
	12	G1/4	3198 12 13	5.5	16	19	29	31	0.021			
	G3/8	3198 12 17	5.5	20	19	27	31	0.024				
	G1/2	3198 12 21	7	24	19	27	31	0.033				
	14	G3/8	3198 14 17	5.5	20	22	32.5	35.5	0.036			
	G1/2	3198 14 21	7	24	22	27	35.5	0.036				
	16	G3/8	3198 16 17	7.5	27	27	54.5	38.5	0.121			
	G1/2	3198 16 21	9	27	27	54.5	38.5	0.117				

The body swivels for positioning purposes.


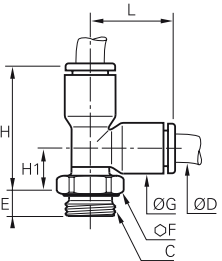


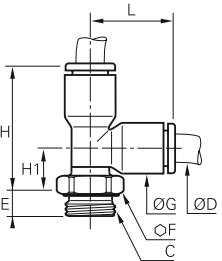
3103 Stud Run Tee, BSPT Thread

	Technical polymer, nickel-plated brass, NBR			ØD	C		F	G	H	H1	L	kg
	4	R1/8		3103 04 10	10	8.5	23.5	9	14.5	0.006		
	R1/4	3103 04 13	14	8.5	24	9.5	14.5	0.015				
	6	R1/8	3103 06 10	10	10.5	27.5	10	17.5	0.007			
	R1/4	3103 06 13	14	10.5	28	10.5	17.5	0.016				
	8	R1/8	3103 08 10	10	13.5	35	12	23	0.009			
	R1/4	3103 08 13	14	13.5	34	11	23	0.015				
	R3/8	3103 08 17	17	13.5	34	11	23	0.020				
	10	R1/4	3103 10 13	15	16	40.5	14	26.5	0.017			
	R3/8	3103 10 17	17	16	40.5	14	26.5	0.022				
	R1/2	3103 10 21	21	16	40.5	14	26.5	0.033				
	12	R1/4	3103 12 13	15	19	46.5	15.5	31	0.028			
	R3/8	3103 12 17	17	19	46.5	15.5	31	0.026				
	R1/2	3103 12 21	21	19	46.5	15.5	31	0.037				
	14	R3/8	3103 14 17	20	22	55	19.5	35.5	0.037			
	R1/2	3103 14 21	24	22	52.5	17.5	35.5	0.048				
	16	R3/8	3103 16 17	27	27	78	27	38.5	0.126			
	R1/2	3103 16 21	27	27	78	27	38.5	0.124				

Pre-coated thread
The body swivels for positioning purposes.


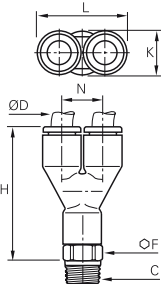


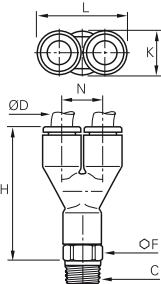
Stud Fittings

3193 Stud Run Tee, Male BSPP and Metric Thread

	Technical polymer, nickel-plated brass, NBR		ØD	C		E	F	G	H	H1	L	kg
			4	M5x0.8 G1/8 G1/4	3193 04 19 3193 04 10 3193 04 13	3.5 8 5 13 5.5 16	8 8.5 23 8.5 23	26 23 23	11.5 8.5 8.5	14.5 14.5 14.5	0.003 0.006 0.011	
	Technical polymer, nickel-plated brass, NBR		6	M5x0.8 G1/8 G1/4	3193 06 19 3193 06 10 3193 06 13	3.5 8 5 13 5.5 16	8 10.5 27 10.5 27	29.5 12.5 10	17.5 17.5 17.5	0.004 0.007 0.012		
			8	G1/8 G1/4	3193 08 10 3193 08 13	4.5 13 5.5 16	13.5 34.5 13.5 34.5	14 12	23 23	0.011 0.014		
			10	G3/8 G1/4	3193 08 17 3193 10 13	5.5 20 5.5 16	13.5 42 16 42	15.5 15.5	26.5 26.5	0.017 0.020		
				G3/8 G1/2	3193 10 17 3193 10 21	5.5 20 7.5 24	16 40.5 16 40.5	14 14	26.5 26.5	0.020 0.029		
			12	G1/4 G3/8	3193 12 13 3193 12 17	5.5 16 5.5 20	19 48 19 46.5	17 15.5	31 31	0.021 0.024		
				G1/2	3193 12 21	7 24	19 46.5	15.5	31	0.038		
			14	G3/8 G1/2	3193 14 17 3193 14 21	5.5 20 7 24	22 56.5 22 51	21.5 16	35.5 35.5	0.107 0.120		
				G3/8 G1/2	3193 16 17 3193 16 21	7.5 27 9 27	27 79.5 27 79.5	41 41	38.5 38.5	0.121 0.117		


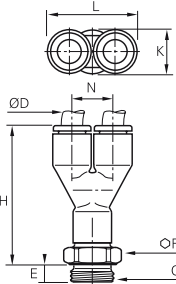


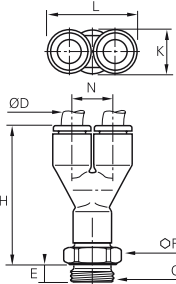
The body swivels for positioning purposes.

3148 Y Piece, Male BSPT Thread

	Technical polymer, nickel-plated brass, NBR		ØD	C		F	H	K	L	N	kg
			4	R1/8 R1/4	3148 04 10 3148 04 13	10 14	32.5 33	8.5 8.5	17.5 17.5	9 9	0.010 0.019
	Technical polymer, nickel-plated brass, NBR		6	R1/8 R1/4	3148 06 10 3148 06 13	10 14	39.5 40	10.5 10.5	21.5 21.5	11 11	0.011 0.021
			8	R1/8 R1/4	3148 08 10 3148 08 13	13 14	56.5 55.5	13.5 13.5	28 28	14.5 14.5	0.020 0.025
				R3/8	3148 08 17	16	48.5	13.5	28	14.5	0.034
			10	R1/4 R3/8	3148 10 13 3148 10 17	14 16	60 60.5	19 19	39 39	20 20	0.033 0.042
				R1/2	3148 10 21	24	61	19	39	20	0.062
			12	R3/8 R1/2	3148 12 17 3148 12 21	19 21	66 66	19 19	39 39	20 20	0.054 0.059

Pre-coated thread
The body swivels for positioning purposes.


3158 Y Piece, Male BSPP and Metric Thread

	Technical polymer, nickel-plated brass, NBR		ØD	C		E	F	H	K	L	N	kg
			4	M5x0.8 G1/8 G1/4	3158 04 19 3158 04 10 3158 04 13	3.5 8 5 13 5.5 16	8 32 32.5	8.5 8.5 8.5	17.5 17.5 17.5	9 9 9	0.006 0.009 0.014	
	Technical polymer, nickel-plated brass, NBR		6	M5x0.8 G1/8 G1/4	3158 06 19 3158 06 10 3158 06 13	3.5 10 5 13 5.5 16	39.5 10.5 39.5	10.5 10.5 10.5	21.5 11 21.5	11 11 11	0.009 0.012 0.017	
			8	G1/8 G1/4	3158 08 10 3158 08 13	5 13 5.5 16	49 49.5	13.5 13.5	28 28	14.5 14.5	0.020 0.023	
				G3/8	3158 08 17	6 19	48	13.5	28	14.5	0.030	
			10	G1/4 G3/8	3158 10 13 3158 10 17	5.5 16 6 20	58 57.5	16 16	33 33	17 17	0.031 0.039	
				G1/2	3158 10 21	7 24	58	16	33	17	0.053	
			12	G3/8 G1/2	3158 12 17 3158 12 21	6 20 7 24	62 63	19 19	39 39	20 20	0.044 0.049	

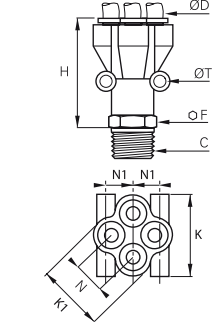
The body swivels for positioning purposes.

Stud Fittings

3112 Double Y Piece, Male BSPT Thread




Technical polymer, nickel-plated brass, NBR



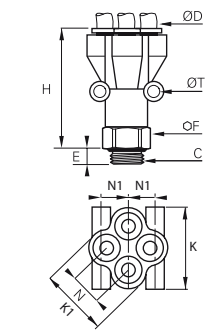
ØD	C		F	H	K	K1	N	N1	ØT	kg
4	R1/8	3112 04 10	13	41.5	25.5	21	10	8.5	3.7	0.023
	R1/4	3112 04 13	14	43.5	25.5	21	10	8.5	3.7	0.027
6	R1/8	3112 06 10	19	54.5	31.5	26.5	12	10	3.7	0.041
	R1/4	3112 06 13	19	57.5	31.5	26.5	12	10	3.7	0.047

Pre-coated thread
The body swivels for positioning purposes.

3132 Double Y, Male BSPP Thread




Technical polymer, nickel-plated brass, NBR



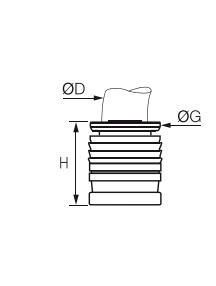
ØD	C		E	F	H	K	K1	N	N1	ØT	kg
4	G1/8	3132 04 10	5	13	41	25.5	21	10	8.5	3.7	0.023
	G1/4	3132 04 13	5.5	16	40	25.5	21	10	8.5	3.7	0.025
6	G1/8	3132 06 10	5	19	53.5	31.5	26.5	12	10	3.7	0.040
	G1/4	3132 06 13	5.5	19	52.5	31.5	26.5	12	10	3.7	0.045

The body swivels for positioning purposes.

3100 Carstick® Cartridge




Brass, NBR




ØD		G	G1	H	L	kg
4	3100 04 00	8	11	10	554	0.001
6	3100 06 00	10	14.5	11.5	629	0.002
8	3100 08 00	13	15	15	794	0.002
10	3100 10 00	15.5	19.5	17	930	0.005
12	3100 12 00	19.5	21	19.5	1038	0.010

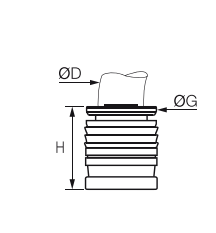
50 cartridges per Carstick®
Cavity dimensions are available in chapter 2.



3100 Carstick® Cartridge




Nickel-plated brass, NBR



ØD		G	G1	H	L	kg
1/8	3100 53 00 99	7	10	9	508	0.002
1/4	3100 56 00 99	10.5	14.5	12	600	0.003
3/8	3100 60 00 99	15.5	19	16.5	930	0.006


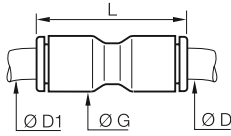

50 cartridges per Carstick®
Cavity dimensions are available in chapter 2.



Other products are available upon request; please do not hesitate to consult us.


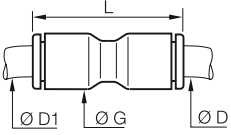

Tube-to-Tube Fittings

3106 Equal and Unequal Tube-to-Tube Connector


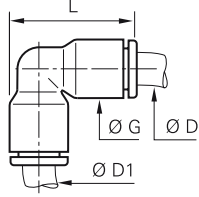

	Technical polymer, NBR 	ØD	ØD1		G	L	kg
		3	3	3106 03 00	8.5	25	0.002
			4	3106 03 04	8.5	25	0.002
			1/4	3106 04 56	11	29.5	0.010
		4	4	3106 04 00	8.5	25	0.001
			6	3106 04 06	11	28	0.002
			8	3106 04 08	13.5	38	0.005
			1/4	3106 06 56	13.5	36	0.009
			6	3106 06 00	10.5	28.5	0.002
			8	3106 06 08	13.5	38	0.005
			10	3106 06 10	16	42	0.007
		8	8	3106 08 00	13.5	38	0.004
			10	3106 08 10	16	42	0.008
			12	3106 08 12	19	50.5	0.026
		10	10	3106 10 00	16	42	0.006
			12	3106 10 12	19	50.5	0.022
			1/2	3106 12 62	22	56.5	0.024
		12	12	3106 12 00	19	50.5	0.009
			14	3106 12 14	22	56	0.026
			16	3106 12 16	27	61	0.066
14	14	3106 14 00	22	56	0.014		
16	16	3106 16 00	27	60.5	0.041		

3106 Equal and Unequal Tube-to-Tube Connector

Inch


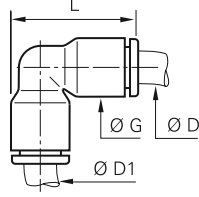

	Technical polymer, NBR 	ØD	ØD1		G	L	kg
		1/4	1/4	3106 56 00	10.9	29.5	0.002
			3/8	3106 60 00	16	42	0.006
		3/8	10	3106 60 10	12	50.5	0.029
			1/4	3106 60 56	16	41	0.016
		1/2	1/2	3106 62 00	22	55	0.015
		5/32" (4 mm) and 5/16" (8 mm) also available					

3102 Equal and Unequal Elbow

	Technical polymer, NBR 	ØD	ØD1		G	L	kg
		4	4	3102 04 00	8.5	19	0.001
			6	3102 04 06	10.5	22.5	0.004
		6	6	3102 06 00	10.5	22.5	0.002
			8	3102 06 08	13.5	29.5	0.009
			8	3102 08 00	13.5	29.5	0.004
			10	3102 08 10	16	34.5	0.031
		10	10	3102 10 00	16	34.5	0.006
			12	3102 10 12	19	40.5	0.022
			12	3102 12 00	19	40.5	0.010
			14	3102 14 00	22	46.5	0.015
			16	3102 16 00	27	52	0.043


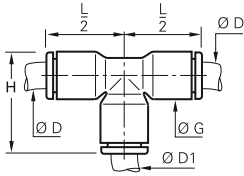

3102 Equal Elbow

Inch

	Technical polymer, NBR 	ØD	ØD1		G	L	kg
		1/4	1/4	3102 56 00	11	23.5	0.002
		3/8	3/8	3102 60 00	16	34	0.006
		1/2	1/2	3102 62 00	22	35	0.018
		5/32" (4 mm) and 5/16" (8 mm) also available					


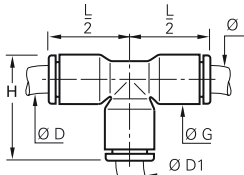

Tube-to-Tube Fittings

3104 Equal and Unequal Tee

	Technical polymer, NBR 	ØD	ØD1		G	H	L/2	kg
		3	3	3104 03 00	8.5	19	14.5	0.004
		4	4	3104 04 00	8.5	19	14.5	0.002
		4	6	3104 04 06	10.5	22.5	17.5	0.007
		6	4	3104 06 04	10.5	22.5	17.5	0.005
		6	6	3104 06 00	10.5	22.5	17.5	0.003
		8	8	3104 06 08	13.5	29.5	23	0.015
		4	8	3104 08 04	13.5	29	22.5	0.114
		8	6	3104 08 06	13.5	29.5	23	0.010
		8	8	3104 08 00	13.5	29.5	23	0.006
		10	10	3104 08 10	16	34.5	26.5	0.021
		4	10	3104 10 04	16	39	31	0.027
		8	10	3104 10 08	16	34.5	26.5	0.014
		10	10	3104 10 00	16	34.5	26.5	0.009
		12	12	3104 10 12	19	40.5	31	0.036
		4	12	3104 12 04	19	39	31	0.034
		12	10	3104 12 10	19	40.5	31	0.024
		12	12	3104 12 00	19	40.5	31	0.014
		14	8	3104 14 08	22	46	35.5	0.054
		14	14	3104 14 00	22	46	35.5	0.023
		16	12	3104 16 12	27	52.5	39	0.088
		16	16	3104 16 00	27	52	39	0.063


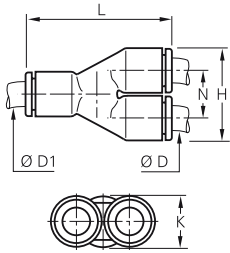

3104 Equal and Unequal Tee

Inch

	Technical polymer, NBR 	ØD	ØD1		G	H	L/2	kg
		5/32	1/4	3104 04 56	11	23.5	18	0.014
		1/8	1/8	3104 53 00	8.4	19	14.5	0.003
		1/8	1/4	3104 53 56	11	23.5	18	0.011
		3/16	3/16	3104 55 00	10.9	27.2	21.6	0.015
		5/32	5/32	3104 56 04	11	23.5	18.5	0.014
		1/4	1/4	3104 56 00	11	23	24	0.003
		1/8	3/8	3104 56 53	11	23.5	18.5	0.007
		3/8	3/8	3104 56 60	16	33.5	24.5	0.017
		1/4	1/4	3104 60 56	16	32.5	25.5	0.019
		3/8	1/2	3104 60 62	22	46	35	0.070
		3/8	3/8	3104 60 00	16	34	26	0.009
		1/2	1/2	3104 62 00	22	46	35	0.026
		1/2	1/4	3104 62 56	22.1	45.2	35.3	0.021
		3/8	3/8	3104 62 60	22	46	35	0.060

5/32" (4 mm) and 5/16" (8 mm) also available

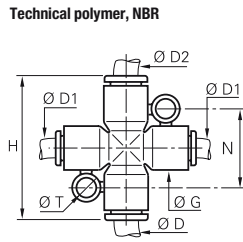
3140 Equal and Unequal Single Y Piece


	Technical polymer, NBR 	ØD	ØD1		H	K	L	N	kg
		4	4	3140 04 00	17.5	8.5	28.5	9	0.002
		4	6	3140 04 06	17.5	10.5	33	9	0.003
		6	6	3140 06 00	21.5	10.5	35	11	0.003
		6	8	3140 06 08	22.5	13.5	41	11.5	0.005
		8	8	3140 08 00	28	13.5	45	14.5	0.007
		8	10	3140 08 10	28	16	47	14.5	0.011
		10	10	3140 10 00	33	16	53	17	0.010
		10	12	3140 10 12	33	19	57	17	0.018
		12	12	3140 12 00	39	19	57	17	0.028

Tube-to-Tube Fittings

3107

Equal and Unequal Cross



ØD	ØD1	ØD2		G	H	N	ØT	kg
4	4	4	3107 04 00	11	36	20	4.2	0.013
6	4	6	3107 04 06	11	36	20	4.2	0.010
4	4	6	3107 06 04	11	36	20	4.2	0.011
6	6	6	3107 06 00	11	36	20	4.2	0.005
8	6	8	3107 06 08	11	46	22.5	4.2	0.018
6	6	8	3107 08 06	13.5	46	22.5	4.2	0.023
8	8	8	3107 08 00	13.5	46	22.5	4.2	0.020


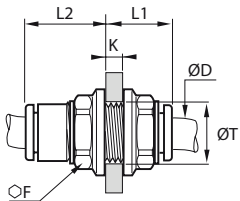

Boxes protect the contents and are designed to meet your requirements:

- part numbers and corresponding product pictures allow for immediate visual identification
- bar codes
- easy storage
- tamper-proof system of opening/closing
- recyclable material


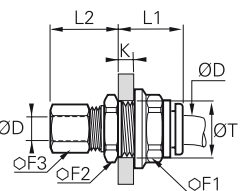



Bulkhead Connector Fittings

3116 Equal Bulkhead Connector


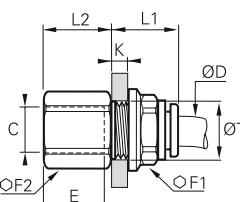

	Technical polymer, NBR 	ØD		F	K_{max}	L1	L2	ØT_{min}	kg
		4	3116 04 00	13	5.5	15	10	10.5	0.003
		6	3116 06 00	15	8.5	18	10.5	12.5	0.004
		8	3116 08 00	18	14.5	25	13.5	15.5	0.007
		10	3116 10 00	22	14.5	27.5	15.5	18.5	0.015
		12	3116 12 00	26	18.5	33	18	22.5	0.019
		14	3116 14 00	29	20.5	37.5	20.5	25.5	0.028

3146 Equal Mixed Bulkhead Connector


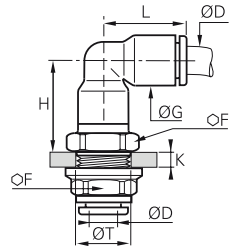

	Nickel-plated brass, NBR 	ØD		F1	F2	F3	K_{max}	L1	L2	ØT_{min}	kg
		4	3146 04 00	13	13	10	7	17.5	17.5	10.5	0.018
		6	3146 06 00	15	17	13	8	19	18	12.5	0.029
		8	3146 08 00	18	19	14	8	20.5	20.5	15.5	0.036
		10	3146 10 00	22	22	19	8.5	23	24.5	18.5	0.065
		12	3146 12 00	26	25	22	8.5	27	25	22.5	0.096
		14	3146 14 00	29	29	24	10.5	27	27	25.5	0.125

Push-in connection with compression fitting

3136 Bulkhead Connector, Female BSPP Thread

	Nickel-plated brass, NBR 	ØD	C		E	F1	F2	K_{max}	L1	L2	ØT_{min}	kg
		4	G1/8	3136 04 10	9.5	13	13	7	17	11.5	10.5	0.015
		4	G1/4	3136 04 13	13.5	13	16	7	17	15.5	10.5	0.021
		6	G1/8	3136 06 10	9.5	15	15	8	19	10.5	12.5	0.020
		6	G1/4	3136 06 13	13.5	15	17	7	19	15.5	12.5	0.027
		6	G3/8	3136 06 17	12	15	22	8	19	16	12.5	0.041
		8	G1/8	3136 08 10	9.5	18	17	8	20.5	10.5	15.5	0.029
		8	G1/4	3136 08 13	13.5	18	17	8	20.5	14.5	15.5	0.029
		10	G3/8	3136 10 17	14	22	22	8.5	23	16	18.5	0.051
		12	G3/8	3136 12 17	14	26	24	8.5	27	16	22.5	0.078
		12	G1/2	3136 12 21	19.5	26	27	8.5	27	21.5	22.5	0.097
		16	G3/8	3136 16 17	12	29	29	10.5	30	15	27.5	0.125
		16	G1/2	3136 16 21	15	29	29	10.5	30	19.5	27.5	0.126


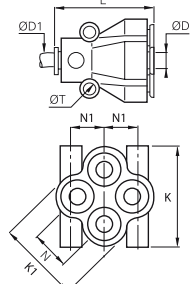

3139 Equal Bulkhead Elbow

	Technical polymer, nickel-plated brass, NBR 	ØD		F	G	H	K_{max}	L	ØT_{min}	kg
		4	3139 04 00	13	8.5	17	6.5	14.5	10.5	0.014
		6	3139 06 00	15	10.5	19.5	7	17.5	12.5	0.021
		8	3139 08 00	18	13.5	24	8	23	15.5	0.032
		10	3139 10 00	22	16	28	8.5	26	18.5	0.050
		12	3139 12 00	26	19	33	8.5	31	22.5	0.086
		14	3139 14 00	29	25.5	37.5	10.5	36	25.5	0.116


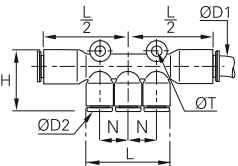

The body swivels for positioning purposes.

Multiple Fittings


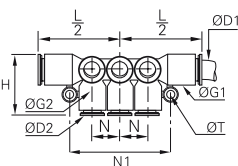

3144 Equal and Unequal Multiple Y Piece

	Technical polymer, NBR 	ØD	ØD1		K	K1	L	N	N1	ØT	kg
		4	4	3144 04 04	25.5	21	30.5	10	8.5	3.7	0.015
		4	6	3144 04 06	26	21	30.5	10	10	3.7	0.013
		6	6	3144 06 06	31.5	26.5	37.5	12	8.5	3.7	0.034
		6	8	3144 06 08	31.5	26.5	38	12	10	3.7	0.026


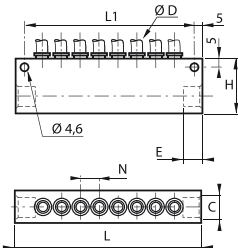

3304 Multiple Tee

	Technical polymer, NBR 	ØD1	ØD2		H	L	L/2	N	ØT	kg
		6	4	3304 06 04	24.5	34	37	11.5	4.2	0.015
		8	4	3304 08 04	24.5	34	37	11.5	4.2	0.012
		8	6	3304 08 06	24.5	34	37	11.5	4.2	0.010
		10	6	3304 10 06	36	44	40.5	14.5	4.2	0.019
			8	3304 10 08	36	44	40.5	15.5	4.2	0.015

3306 90° Multiple Elbow


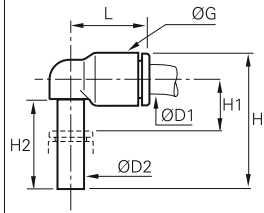

	Technical polymer, NBR 	ØD1	ØD2		G	G1	H	L/2	N	N1	ØT	kg
		6	4	3306 06 04	13.5	11	18.5	36	43	11.5	4.2	0.034
		8	4	3306 08 04	13.5	11	18.5	36.5	43	11.5	4.2	0.025
		8	6	3306 08 06	13.5	11	18.5	36.5	43	11.5	4.2	0.022
		10	6	3306 10 06	16	13.5	23	42	52	14.5	4.2	0.048
			8	3306 10 08	16	13.5	23.5	42	52	14.5	4.2	0.036

3310 In-Line Manifold

	Treated aluminium, NBR 	ØD	C		Number of Outlets	E	H	L	L1	N	kg
		4	G1/4	3310 04 13	8	10	33	114	104	11.5	0.175
		6	G1/4	3310 06 13	8	10	33	114	104	12.5	0.170
		8	G3/8	3310 08 17	6	12	33	114	104	15	0.157
		10	G1/2	3310 10 21	6	16	48	145.5	135.5	17	0.348
		12	G1/2	3310 12 21	6	16	45	158	148	20.5	0.370


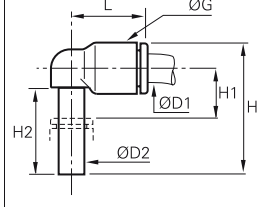

Plug-In Fittings and Accessories

3182 Equal and Unequal Plug-In Elbow

		Technical polymer, NBR	ØD1	ØD2		G	H	H1	H2	L	kg
			4	4	3182 04 00	8.5	23	6	15.5	14	0.001
			4	6	3182 04 06	10.5	26.5	7	17	16	0.003
			6	4	3182 06 04	10.5	24.5	7	15.5	16	0.001
			6	6	3182 06 00	10.5	26.5	7	17	16	0.001
			6	8	3182 06 08	13.5	33.5	8	21.5	23	0.007
			8	8	3182 08 00	13.5	33.5	8	21.5	23	0.003
			8	10	3182 08 10	16	39	10	24.5	26.5	0.010
			10	10	3182 10 00	16	39	10	24.5	26.5	0.004
			10	12	3182 10 12	19	44.5	10.5	27.5	31	0.017
			12	12	3182 12 00	19	45.5	10.5	27.5	31	0.007


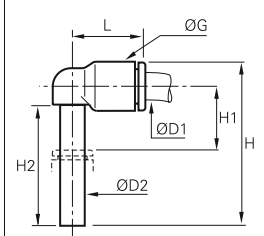

3182 Equal Plug-In Elbow

Inch


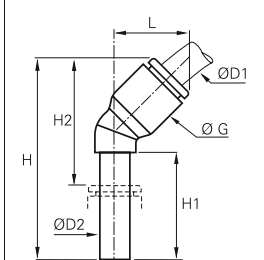

		Technical polymer, NBR	ØD1	ØD2		G	H	H1	H2	L	kg
			1/4	1/4	3182 56 00	11	27.5	7.5	18	18.5	0.002
			3/8	3/8	3182 60 00	16	38.5	9	24	26	0.010
			1/2	1/2	3182 62 00	22	51	13	28	35	0.030

5/32" (4 mm) and 5/16" (8 mm) also available

3184 Extended Equal and Unequal Plug-In Elbow


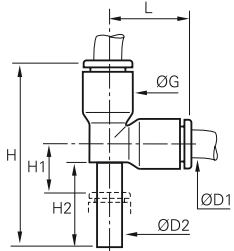

		Technical polymer, NBR	ØD1	ØD2		G	H	H1	H2	L	kg
			4	4	3184 04 00	8.5	32.5	15.5	25	14	0.004
			4	6	3184 04 06	10.5	38.5	19	29	16	0.004
			6	6	3184 06 00	10.5	38.5	19	29	16	0.002
			6	8	3184 06 08	13.5	49	23.5	37	23	0.010
			8	8	3184 08 00	13.5	49	23.5	37	23	0.003
			8	10	3184 08 10	16	56	26.5	41.5	26.5	0.013
			10	10	3184 10 00	16	56	26.5	41.5	26.5	0.010
			10	12	3184 10 12	19	62.5	28	45.5	31	0.020
			12	12	3184 12 00	19	62.5	28	45.5	31	0.014

3180 45° Plug-In Equal Elbow


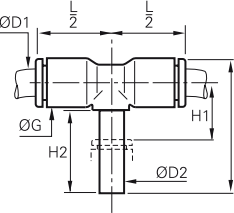

		Technical polymer, NBR	ØD1	ØD2		G	H	H1	H2	L	kg
			4	4	3180 04 00	9	33.5	19	21	13	0.001
			6	6	3180 06 00	11	39	21	25	14.5	0.003
			8	8	3180 08 00	13.5	44	21.5	25.5	19.5	0.005
			10	10	3180 10 00	16	53	27	32.5	23	0.004
			12	12	3180 12 00	19	58.5	27.5	34	26.5	0.007

Plug-In Fittings and Accessories


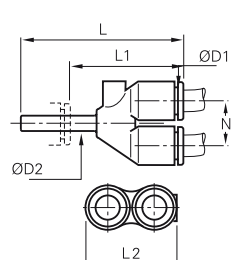

3183 Equal and Unequal Plug-In Run Tee

		Technical polymer, NBR	ØD1	ØD2		G	H	H1	H2	L	kg
			4	4	3183 04 00	8.5	33	6	15.5	14.5	0.002
			4	6	3183 04 06	10.5	38.5	7	17	17.5	0.006
			6	6	3183 06 00	10.5	38.5	7	17	17	0.002
			6	8	3183 06 08	13.5	48.5	8	21.5	23	0.014
			8	8	3183 08 00	13.5	49	8	21.5	23	0.004
			8	10	3183 08 10	16	56.5	10.5	24.5	26.5	0.018
			10	10	3183 10 00	16	57	10.5	24.5	26.5	0.007
			10	12	3183 10 12	19	65.5	10.5	27.5	31	0.034
			12	12	3183 12 00	19	65.5	10.5	27.5	31	0.011


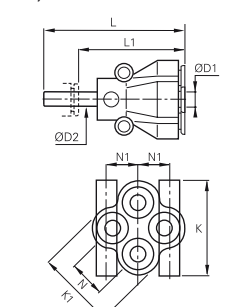

3188 Equal and Unequal Plug-In Branch Tee

		Technical polymer, NBR	ØD1	ØD2		G	H	H1	H2	L/2	kg
			4	4	3188 04 00	8.5	25	8	15.5	14.5	0.002
			4	6	3188 04 06	10.5	28.5	9	17	16	0.007
			6	6	3188 06 00	10.5	28.5	9	17	16	0.002
			6	8	3188 06 08	13.5	36.5	11	21.5	22	0.014
			8	8	3188 08 00	13.5	36.5	11	21.5	23	0.005
			8	10	3188 08 10	16	41	12.5	24.5	26.5	0.018
			10	10	3188 10 00	16	41	12.5	24.5	26.5	0.007
			10	12	3188 10 12	19	46.5	12.5	27.5	31	0.034
			12	12	3188 12 00	19	46.5	12.5	27.5	31	0.020

3142 Equal and Unequal Plug-In Single Y Piece


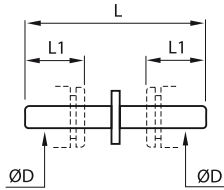

		Technical polymer, NBR	ØD1	ØD2		L	L1	L2	N	kg
			4	4	3142 04 00	34	21.5	17.5	9	0.002
			4	6	3142 04 06	35.5	21.5	17.5	9	0.004
			6	6	3142 06 00	39.5	25.5	21.5	11	0.004
			6	8	3142 06 08	44	25.5	21.5	11	0.015
			8	8	3142 08 00	50.5	32	28	14.5	0.007
			8	10	3142 08 10	53.5	32	28	14.5	0.024
			10	10	3142 10 00	57.5	36	33	17	0.010
			10	12	3142 10 12	60	35	33	17	0.037
			12	12	3142 12 00	66	41	39	20	0.017

3143 Multiple Plug-In Y Piece

		Technical polymer, nickel-plated brass, NBR	ØD1	ØD2		K	K1	L	L1	N	N1	kg
			4	6	3143 04 06	26	21.5	49.5	35.5	11	8.5	0.012
			4	8	3143 04 08	26	21.5	51	32	11	8.5	0.021
			6	8	3143 06 08	31.5	26.5	57.5	39	12	10	0.035


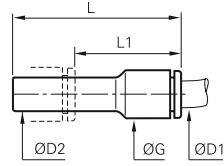

Plug-In Fittings and Accessories

3120 Stem Connector


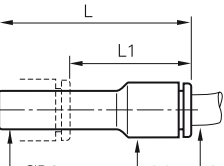

	Technical polymer 	ØD		L	L1	kg
		4	3120 04 00	34.5	12	0.001
		6	3120 06 00	38.5	14	0.001
		8	3120 08 00	41	18.5	0.001
		10	3120 10 00	51.5	20.5	0.002
		12	3120 12 00	60	24.5	0.004
		14	3120 14 00	69.5	25.5	0.007

This model is available in nickel-plated brass; please use suffix 85. Example: 3120 04 00 85.
Only compatible with Parker Legris fittings.
Drawing available upon request.


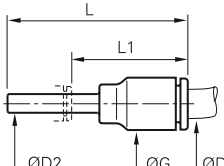

3166 Plug-In Reducer

	Technical polymer, NBR 	ØD1	ØD2		G	L	L1	kg
		3	4	3166 03 04	8.5	37.5	23.5	0.002
		4	6	3166 04 06	8.5	37.5	23.5	0.001
		4	8	3166 04 08	8.5	37.5	19	0.001
			10	3166 04 10	12	44	22.5	0.003
			8	3166 06 08	10.5	37.5	20	0.001
		6	10	3166 06 10	10.5	38	17.5	0.002
			12	3166 06 12	14.5	46	23	0.005
			14	3166 06 14	14.5	48	23	0.006
			10	3166 08 10	13.5	49	28.5	0.003
		8	12	3166 08 12	13.5	49	24.5	0.004
			14	3166 08 14	17	48	23	0.007
			12	3166 10 12	21.5	56.5	33.5	0.006
		10	14	3166 10 14	21.5	58.5	33.5	0.007
		12	14	3166 12 14	23.5	58.5	33.5	0.010


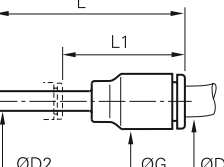

3166 Plug-In Reducer

	Technical polymer, NBR 	ØD1	ØD2		G	L	L1	kg
		1/4	5/16	3166 56 08	11	41	23	0.002
			3/8	3166 56 60	11	41	21	0.002

3168 Plug-In Increaser


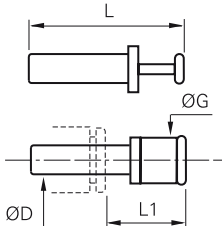

	Technical polymer, NBR 	ØD1	ØD2		G	L	L1	kg
		6	4	3168 06 04	10.5	35	23	0.001
		8	6	3168 08 06	13.5	45	31.5	0.003
			1/4	3168 08 56	16	40	25.5	0.008
		10	8	3168 10 08	16	42.5	21	0.009
		12	10	3168 12 10	19	49	24.5	0.012

3168 Plug-In Increaser

	Technical polymer, NBR 	ØD1	ØD2		G	L	L1	kg
		1/4	5/32	3168 56 04	11	41	29	0.001
			3/16	3168 56 55	20.5	41	25	0.003

Plug-In Fittings and Accessories


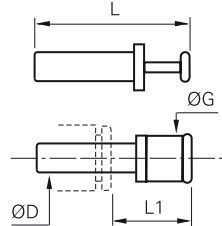

3126 Blanking Plug

	Technical polymer 	ØD		G	L	L1	kg
		3	3126 03 00	6	25	13.5	0.001
		4	3126 04 00	4	30	15.5	0.001
		6	3126 06 00	8	33	16.5	0.001
		8	3126 08 00	10	35	17.5	0.001
		10	3126 10 00	12	42	21	0.002
		12	3126 12 00	14	45	22	0.003
		14	3126 14 00	16	49	23.5	0.005
		16	3126 16 00*	19	57	30	0.063

*Nickel-plated brass


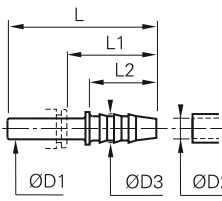

3126 Blanking Plug

Inch


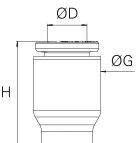

	Technical polymer 	ØD		G	L	L1	kg
		1/4	3126 56 00	8	36.5	22	0.001
		3/8	3126 60 00	12	42	22	0.002
		1/2	3126 62 00	15	48.5	21.5	0.003

5/32" (4 mm) and 5/16" (8 mm) also available

3122 Plug-In Barb Connector

	Technical polymer 	ØD1	ØD2		ØD3	L	L1	L2	kg
		4	3.2	3122 04 53	5	37	25	17	0.004
			5	3122 04 05	7	37	25	17	0.005
		6	5	3122 06 05	7	39	25	17	0.001
		8	6.3	3122 08 56	8.5	39.5	21	17	0.001
			8	3122 08 08	10	44.5	26	22	0.001
		10	6.3	3122 10 56	8	45	24.5	17	0.002
			8	3122 10 08	10	50	29.5	22	0.002
			8	3122 12 08	10	50	26	22	0.002
		12	10	3122 12 10	12	48.5	25.5	22.5	0.002
			12.5	3122 12 62	14.5	57	34	22.5	0.004
		14	12.5	3122 14 62	14.5	59.5	34.5	22.5	0.022

3151 End Cap

	Technical polymer, NBR 	ØD		G	H	kg
		4	3151 04 00	8.5	14.7	0.001
		6	3151 06 00	10.5	16.9	0.001
		8	3151 08 00	13.5	21.9	0.002
		10	3151 10 00	16	22.2	0.003
		12	3151 12 00	19	27.7	0.006
		14	3151 14 00	22	28	0.014

Other products are available upon request; please do not hesitate to consult us.

Banjo Fittings

This range of fittings is ideal when access is only possible from above and **orientation of the tube** is required. This range of modular fittings includes single and multiple configurations, allowing **wide flexibility of design**.

Product Advantages

- Compact**
- Compact design with minimum space between fittings
 - Banjo bolt designed for maximum flow
 - Easy access, even when fittings are close together
 - Easy assembly and automatic sealing:
 - with pre-coating on taper threads
 - with an integral O-ring seal on parallel threads
 - Safe operation: orientation of tube is ensured
 - 100% leak-tested in production
 - Date coding to guarantee quality and traceability

- Modular**
- Effortless stacking of banjo bodies to allow construction of 2 to 6 outlets
 - Orientable (360°) for perfect alignment
 - Modular: tube diameters may be different



- Applications**
- Robotics
 - Automotive Process
 - Pneumatics
 - Semi-Conductors
 - Textile
 - Packaging

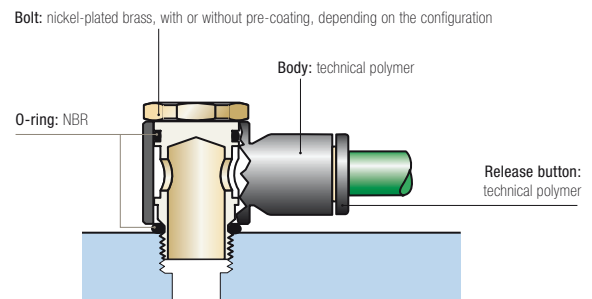
Technical Characteristics

Compatible Fluids	Compressed air Other fluids: please consult us
Working Pressure	Vacuum to 20 bar
Working Temperature	-20°C to +80°C

Tightening Torque (daN.m)	Threads					
	M3 x0.5	M5 x0.8	G1/8	G1/4	G3/8	G1/2
	0.05	0.1	0.4	0.5	0.6	0.7

Reliable performance is dependent upon the type of fluid conveyed, component materials and tubing being used. Use is guaranteed with a vacuum of 755 mm Hg (99% vacuum).

Component Materials



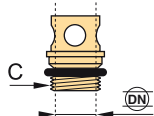
Silicone-free

Regulations

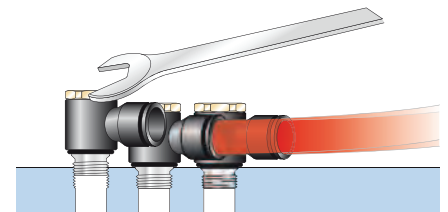
- ISO 14743: Pneumatic fluid power, push-in connectors for thermoplastic tubes
- DI: 2002/95/EC (RoHS)
2011/65/EC
DI: 1907/2006 (REACH)
DI: 97/23/EC (PED)

Installation Configurations

Thread and bore diameters for part numbers 3524 - 3527 - 3528 - 3529:


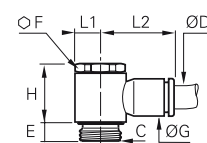



Thread (C)	M5x0.8	G1/8	G1/4	G3/8	G1/2
DN	2.5	5.5	8.5	11	13




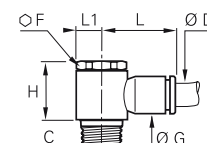

Banjo Fittings

3118 Single Banjo, Male BSPP and Metric Thread

	Technical polymer, nickel-plated brass, NBR			ØD	C		E	F	G	H	L1	L2	kg
	3	M3x0.5		3118 03 09*	3		-	8.5	13	5	16	0.005	
		M5x0.8		3118 03 19*	4		-	8.5	13	5	16	0.005	
	4	M5x0.8		3118 04 19*	4		-	8.5	13	5	16.5	0.004	
		G1/8		3118 04 10	4		13	8.5	17	7	18.5	0.012	
		M5x0.8		3118 06 19*	4		-	10.5	13	7	18.5	0.004	
	6	G1/8		3118 06 10	4		13	10.5	17	7	20	0.013	
		G1/4		3118 06 13	5.5		17	10.5	21	9.5	22	0.023	
		G1/8		3118 08 10	4		13	13.5	16.5	7	25	0.013	
	8	G1/4		3118 08 13	5.5		17	13.5	21	9	27	0.024	
		G3/8		3118 08 17	5.5		20	13.5	24.5	11	29	0.038	
		G1/4		3118 10 13	5.5		17	16	21	9.5	29	0.025	
	10	G3/8		3118 10 17	5.5		20	16	24.5	11	31	0.039	
		G1/2		3118 10 21	8		25	19	27.5	13.5	36.5	0.083	
12	G3/8	3118 12 17	5.5	20	19	24.5	11	34.5	0.044				
	G1/2	3118 12 21	8	25	19	27.5	13.5	36.5	0.074				


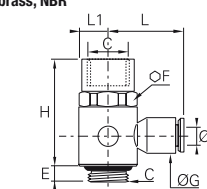

*With screwdriver slot

3018 Single Banjo, Male BSPT Thread

	Technical polymer, nickel-plated brass, NBR			ØD	C		F	G	H	L	L1	kg
	4	R1/8		3018 04 10	13		8.5	18.5	18.5	7	0.015	
	6	R1/8		3018 06 10	13		10.5	18.5	20	7	0.015	
		R1/4		3018 06 13	17		10.5	22.5	22	9.5	0.029	
		R1/8		3018 08 10	13		13.5	18.5	25	7	0.016	
	8	R1/4		3018 08 13	17		13.5	22.5	27	9.5	0.030	
		R3/8		3018 08 17	21		13.5	26.5	29	11	0.047	
	10	R1/4		3018 10 13	17		16	22.5	29	9.5	0.032	
		R3/8		3018 10 17	21		16	26.5	31	11	0.048	
		R1/4		3018 12 13	21		19	26.5	34.5	11	0.052	
12	R3/8	3018 12 17	21	19	26.5	34.5	11	0.050				
	R1/2	3018 12 21	25	19	30	37	13.5	0.086				


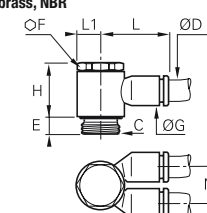

Pre-coated thread

3124 Single Banjo, Male/Female BSPP and Metric Thread

	Technical polymer, nickel-plated brass, NBR			ØD	C		E	F	G	H	L	L1	kg
	4	M5x0.8		3124 04 19	4		8	8.5	19	16	5	0.006	
		G1/8		3124 04 10	4		13	8.5	25.5	18.5	7	0.015	
	6	G1/4		3124 06 13	5.5		17	10.5	33	22	9	0.030	
	8	G3/8		3124 08 17	5.5		20	13.5	37.5	29	11	0.056	


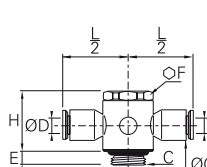

This product family was developed to allow assembly of a function fitting on a cylinder.

3149 Twin Banjo, Male BSPP and Metric Thread

	Technical polymer, nickel-plated brass, NBR			ØD	C		E	F	G	H	L	L1	N	kg
	4	M5x0.8		3149 04 19*	4		-	8.5	13	16	4.5	9	0.005	
		G1/8		3149 04 10	4		13	10.5	16.5	18.5	7	11.5	0.018	
	6	G1/8		3149 06 10	4		13	10.5	16.5	18.5	7	11.5	0.014	
		G1/4		3149 06 13	5.5		17	13.5	21	27	9.5	14.5	0.035	
	8	G1/4		3149 08 13	5.5		17	13.5	21	27	9.5	14.5	0.026	
		G3/8		3149 08 17	5.5		20	16	24.5	31	11	17	0.053	
10	G3/8	3149 10 17	5.5	20	16	24.5	31	11	17	0.042				

*With screwdriver slot


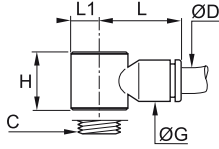

3119 Double Banjo, BSPP and Metric Thread

	Technical polymer, nickel-plated brass, NBR			ØD	C		E	F	G	H	L/2	kg
	4	M5x0.8		3119 04 19*	4		-	8.5	13	8	0.005	
		G1/8		3119 04 10	4		13	11	17	20	0.021	
	6	G1/8		3119 06 10	4		13	11	17	20	0.024	
		G1/4		3119 06 13	5.5		17	13.5	21	26.5	0.031	
	8	G1/4		3119 08 13	5.5		17	13.5	21	27	0.033	
	G3/8	3119 08 17	5.5	20	16	24.5	30.5	0.053				
10	G3/8	3119 10 17	5.5	20	16	24.5	31	0.045				


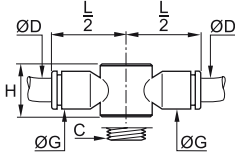

*With screwdriver slot

Banjo Fittings


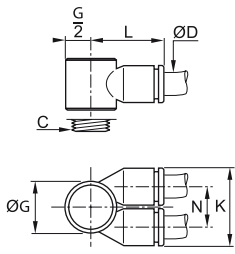

3538 Single Banjo Bodies

	Technical polymer, NBR 	ØD	C		G	H	L	L1	kg
		3	M5x0.8	3538 03 19	8.5	13	16	5	0.003
		4	M5x0.8	3538 04 19	8.5	13	16	5	0.001
			G1/8	3538 04 10	10.5	14.5	18.5	7	0.002
			M5x0.8	3538 06 19	11	13	18.5	5	0.001
		6	G1/8	3538 06 10	10.5	14.5	20	7	0.002
			G1/4	3538 06 13	13.5	18	22	9.5	0.003
			G1/8	3538 08 10	13.5	14.5	25	7	0.003
		8	G1/4	3538 08 13	13.5	18	27	9.5	0.004
			G3/8	3538 08 17	13.5	21.5	29	11.5	0.009
			G1/4	3538 10 13	16	18	29	9.5	0.005
		10	G3/8	3538 10 17	16	21.5	31	11.5	0.006
			G1/2	3538 10 21	19	22.5	36.5	13.5	0.019
		12	G3/8	3538 12 17	19	21.5	34.5	11.5	0.011
			G1/2	3538 12 21	19	22.5	36.5	13.5	0.015

3539 Double Banjo Bodies


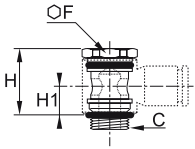

	Technical polymer, NBR 	ØD	C		G	H	L/2	kg
		4	M5x0.8	3539 04 19	8.5	13	16	0.002
			G1/8	3539 04 10	10.5	14.4	20	0.008
			G1/8	3539 06 10	10.5	14.4	20	0.011
		6	G1/4	3539 06 13	13.5	18	26	0.014
			G1/4	3539 08 13	13.5	18	27	0.013
		8	G3/8	3539 08 17	16	21.5	30.5	0.020
		10	G3/8	3539 10 17	16	21.5	31	0.016

3549 Twin Banjo Bodies

	Technical polymer, NBR 	ØD	C		G	K	L	N	kg
		4	M5x0.8	3549 04 19	10	17.5	15.5	9	0.003
			G1/8	3549 04 10	14	22.5	20	12	0.007
			G1/4	3549 04 13	18.5	28	25	14.5	0.019
			G1/8	3549 06 10	14	22.5	20.5	12	0.003
		6	G1/4	3549 06 13	18.5	28	25	14.5	0.017
			G3/8	3549 06 17	22.5	33	28.5	17	0.013
			G1/4	3549 08 13	18.5	28	26	14.5	0.010
		8	G3/8	3549 08 17	22.5	33	29.5	17	0.020
		10	G3/8	3549 10 17	22.5	33	29.5	17	0.016


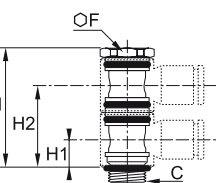

Modular Banjo Fittings

3527 Single Banjo Bolts, Male BSPP and Metric Thread

	Nickel-plated brass, NBR 	C		F	H	H1	kg
		M5x0.8	3527 00 19*	-	17	7.5	0.003
		G1/8	3527 00 10	13	17	7.5	0.011
		G1/4	3527 00 13	17	21	9.5	0.020
		G3/8	3527 00 17	20	24.5	11	0.033
		G1/2	3527 00 21	25	27.5	11.5	0.063


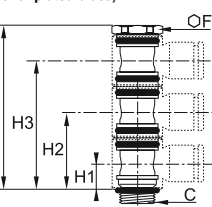

*With screwdriver slot
Full bore

3528 Stacking Banjo for 2 Body High Modules, Male BSPP and Metric Thread

	Nickel-plated brass, NBR 	C		F	H	H1	H2	kg
		M5x0.8	3528 00 19*	-	24.5	7.5	18.5	0.005
		G1/8	3528 00 10	13	31	7.5	22	0.017
		G1/4	3528 00 13	17	39	9.5	27.5	0.031
		G3/8	3528 00 17	20	46	11	32.5	0.053


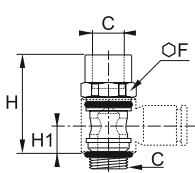

*With screwdriver slot
Full bore
Designed for use with 2 banjo bodies

3529 Stacking Banjo for 3 Body High Modules, Male BSPP Thread

	Nickel-plated brass, NBR 	C		F	H	H1	H2	H3	kg
		G1/8	3529 00 10	13	45.5	7.5	22	36	0.023
		G1/4	3529 00 13	17	54	9.5	27.5	45.5	0.042
		G3/8	3529 00 17	20	67.5	11	32.5	54	0.069

Full bore
Designed for use with 3 banjo bodies


3524 Threaded Banjo Bolts, Male/Female BSPP and Metric Thread

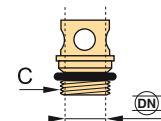
	Nickel-plated brass, NBR 	C		F	H	H1	kg
		M5x0.8	3524 00 19	8	17	7.5	0.005
		G1/8	3524 00 10	13	24.5	7.5	0.013
		G1/4	3524 00 13	17	33	9.5	0.027
		G3/8	3524 00 17	20	37.5	11	0.038
		G1/2	3524 00 21	26	42	11.5	0.067

Full bore

Banjo bolts 3527, 3528, 3529 and 3524 are only usable in association with the corresponding bodies for modular construction 3538, 3539 and 3549.

Thread and passage size for part numbers 3527, 3528, 3529 and 3524.

Thread	M5x0.8	G1/8	G1/4	G3/8	G1/2
	2.5	5.5	8.5	11	13



Modular Plug-In Connectors

These connectors allow a **maximum number of tube connections** in a **minimum of space**. Parker Legris offers an **ergonomic solution** to enable quick connection for the most complex installations.

Product Advantages

- Panel-Mounted**
 - Panel mounted to a machine or bulkhead
 - Reduced risk of incorrect assembly
 - Possible to connect in-line
 - Plated metal joiners and clips for reinforcement
- In-Line**
 - Locating pin prevents incorrect assembly
 - Cap guides the tubes and protects connections
 - Aluminium and technical polymer components
 - Bulkhead mountable
 - Customised multi-connectors upon request
- DIN Rail**
 - Used alongside electrical connectors
 - Pressure indication
 - Can be clipped side-by-side into a DIN rail profile [or Ω
 - Channels or slots for labels for tube identification



Robotics
Automotive Process
Pneumatics
Semi-Conductors
Textile
Packaging

Applications

Technical Characteristics

Compatible Fluids	Compressed air Other fluids: please consult us
Working Pressure	Vacuum to 10 bar
Working Temperature	-20°C to +80°C

Reliable performance is dependent upon the type of fluid conveyed, component materials and tubing being used. Use is guaranteed with a vacuum of 755 mm Hg (99% vacuum).

Component Materials

- Multi-connectors:**
 - panel-mounted: zinc-plated steel, technical polymer
 - in-line: aluminium, technical polymer
 - DIN rail: technical polymer

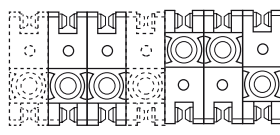
Connections: LF 3000®



Silicone-free

Installation Configurations

Panel-Mounted



Standard assembly Customised assembly

A box contains:

- 10 units
- 20 joining clips and 4 end pins
- 4 mounting brackets
- 4 coupling clips
- 1 dismantling tool

The module is constructed from a number of symmetrical components connected by joining clips. A coupling clip locks the module closed. A dismantling tool allows disconnection.

Maximum 5 modules recommended for the mating module; the fixed module is not limited.

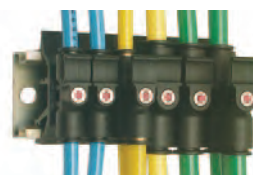
In-Line



Regulations


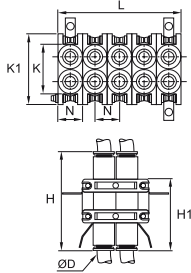

ISO 14743: Pneumatic fluid power, push-in connectors for thermoplastic tubes
 DI: 97/23/EC (PED)
 DI: 2002/95/EC (RoHS), 2011/65/EC
 DI: 1907/2006 (REACH)

DIN Rail Connector




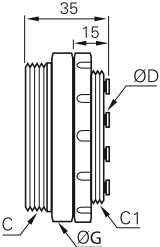

Modular Plug-In Connectors

3300 Modular Plug-In Connector

	Technical polymer, NBR 	$\varnothing D$ 	B	H	H1	K	K1	L	L1	L2	N	kg	
		4	3300 04 00	21	40.5	29.5	32	20	55	22	6	11	0.078
		6	3300 06 00	28	48	38.5	39	27.5	70	28	7.5	14	0.213
		8	3300 08 00	28	50	39	39	27.5	70	28	7.5	14	0.025


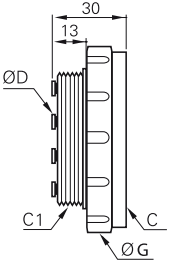

Clearance hole for $\varnothing 3$ mm screw

3320 Multi-Connector Male Screw Body

	Technical polymer, NBR 	$\varnothing D$	C	C1		Number of Outlets	G	kg
		4	M38x1.5	M32x1.5	3320 04 00 02	2	42	0.046
			M46x1.5	M40x1.5	3320 04 00 04	4	50	0.070
			M46x1.5	M40x1.5	3320 04 00 07	7	50	0.072
			M65x1.5	M58x1.5	3320 04 00 12	12	70	0.136
		6	M38x1.5	M32x1.5	3320 06 00 02	2	42	0.050
			M46x1.5	M40x1.5	3320 06 00 04	4	50	0.070
			M46x1.5	M40x1.5	3320 06 00 07	7	50	0.070
			M38x1.5	M32x1.5	3320 08 00 02	2	45	0.050


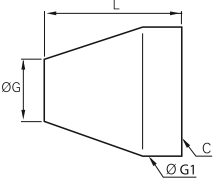

The number of male body outlets must correspond to the same number of outlets on the female body.

3321 Multi-Connector Female Screw Body

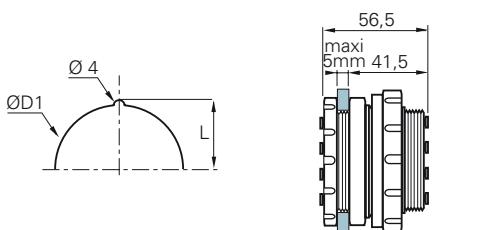
	Technical polymer, NBR 	$\varnothing D$	C	C1		Number of Outlets	G	kg
		4	M38x1.5	M32x1.5	3321 04 00 02	2	45	0.040
			M46x1.5	M40x1.5	3321 04 00 04	4	55	0.065
			M46x1.5	M40x1.5	3321 04 00 07	7	55	0.063
			M65x1.5	M58x1.5	3321 04 00 12	12	75	0.124
		6	M38x1.5	M32x1.5	3321 06 00 02	2	45	0.043
			M46x1.5	M40x1.5	3321 06 00 04	4	55	0.066
			M46x1.5	M40x1.5	3321 06 00 07	7	55	0.064
			M38x1.5	M32x1.5	3321 08 00 02	2	45	0.039

The number of female body outlets must correspond to the same number of outlets on the male body.

3329 Multi-Connector Screw Cap

	Technical polymer 	C 	Number of Outlets	G	G1	L	kg	
		M32x1.5	3329 00 01	2	32	42	50	0.043
		M40x1.5	3329 00 02	4-7	35	50	55	0.058
		M58x1.5	3329 00 03	12	34	70	70	0.139


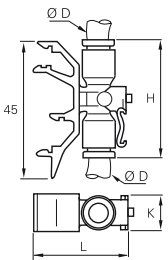

Overall Dimensions for Bulkhead Mounting




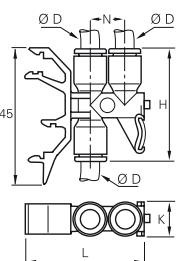

Number of Outlets	L	$\varnothing D1$
2	17	32.5
4-7	21	40.5
12	30.3	58.5

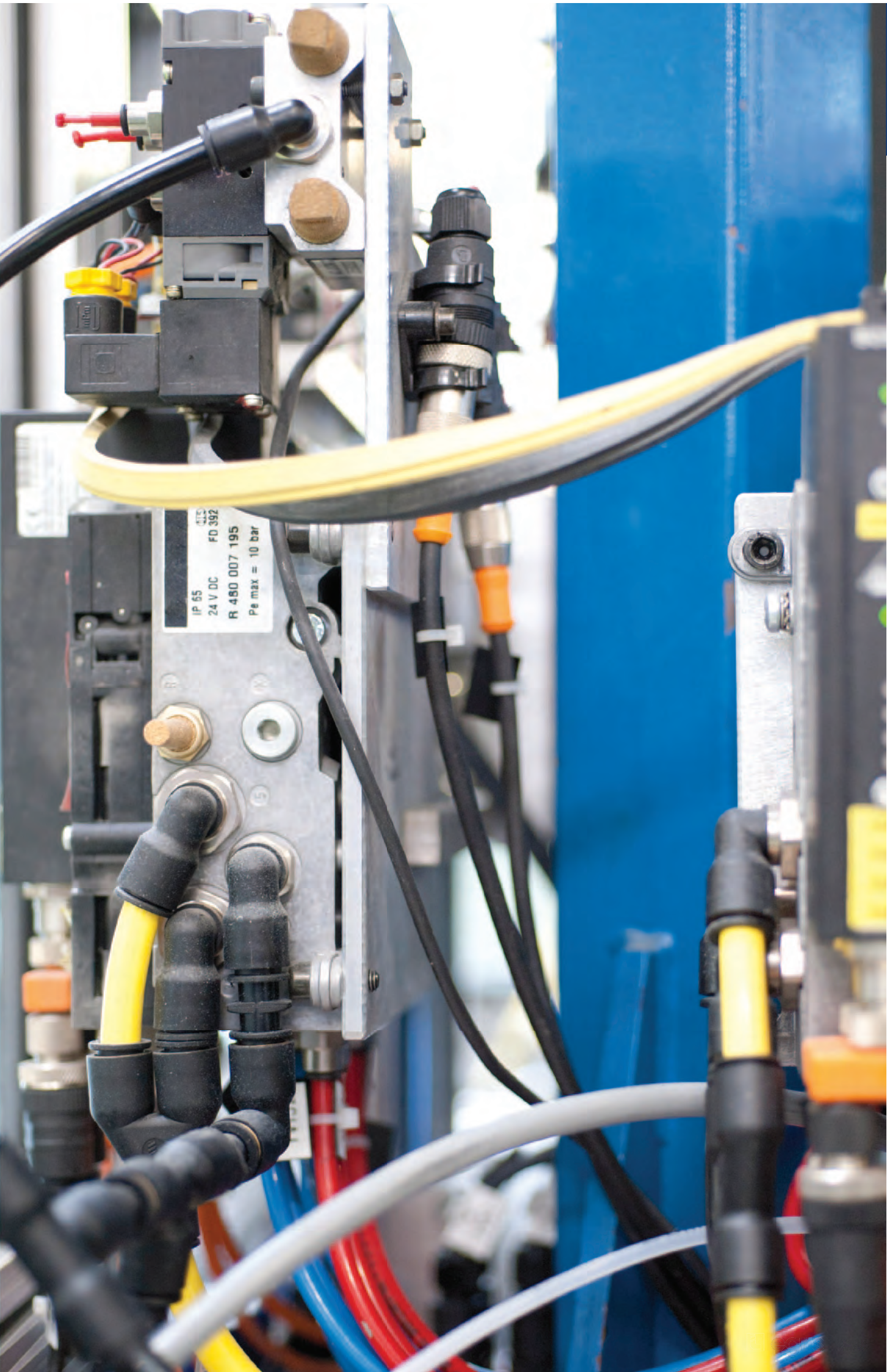
Modular Plug-In Connectors

3379 DIN Rail Connector for 2 Tubes

	<p>Technical polymer, NBR</p> 	<p>ØD </p>	H	K	L	kg	
		4	3379 04 00	34.5	11	39.5	0.016
		6	3379 06 00	34.5	11	39.5	0.026
		8	3379 08 00	46	13	44.5	0.034
<p>Start pressure test point on the system</p>							

3381 DIN Rail Connector for 3 Tubes

	<p>Technical polymer, NBR</p> 	<p>ØD </p>	H	K	L	N	kg	
		4	3381 04 00	36.5	11	39.5	11.5	0.012
		6	3381 06 00	36.5	11	39.5	11.5	0.008
		8	3381 08 00	46	13	44.5	14.5	0.013
<p>Start pressure test point on the system</p>								



LF 3000®

Push-In Fittings

Self-Sealing and Oscillating Fittings

Parker Legris has developed these two **innovative** push-in fittings in order to integrate various functions and allow **quick installation** on pneumatic circuits.

Product Advantages

Self-Sealing Fittings

Prevents fluid flow when there is no tube connected
 Circuits may remain pressurised when being checked and maintained
 When connected, the compressed air flow is restored in both directions

Oscillating Fittings

Rotation matched to cylinder rod stroke
 Prevents tube wear due to excessive flexing
 Optimum reliability and durability
 Simplifies circuit assembly



Applications

Robotics
 Automotive Process
 Pneumatics
 Semi-Conductors
 Textile
 Packaging

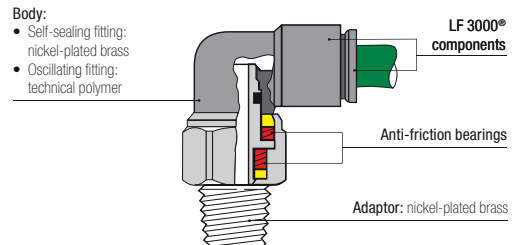
Technical Characteristics

Compatible Fluids	Compressed air Other fluids: please consult us
Working Pressure	Vacuum to 20 bar (10 bar: self-sealing fitting)
Working Temperature	-20°C to +80°C

Reliable performance is dependent upon the type of fluid conveyed, component materials and tubing being used.
 Use is guaranteed with a vacuum of 755 mm Hg (99% vacuum).

Component Materials

Swivel Fitting



Silicone-free

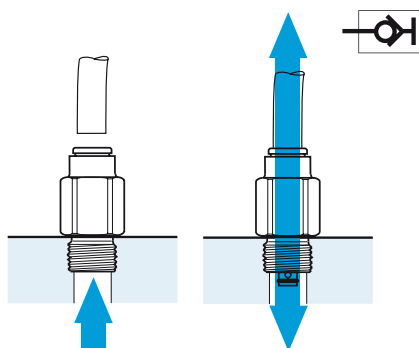
Regulations

ISO 14743: Pneumatic fluid power, push-in connectors for thermoplastic tubes
 DI: 97/23/EC (PED)

DI: 2002/95/EC (RoHS), 2011/65/EC
 DI: 1907/2006 (REACH)

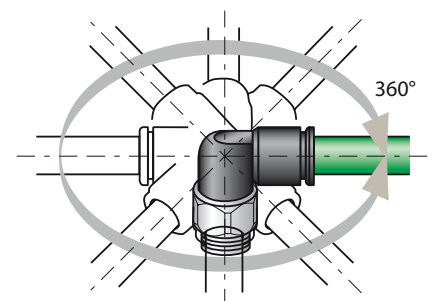
Installation Configurations

Self-Sealing Fitting




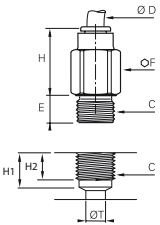

Oscillating Fitting

Tube O.D. (mm)	Torque (daN.m)	Max. Rotation Speed (turn/min.)
4	<math> < 2.5 \cdot 10^{-3}</math>	190
6	<math> < 4 \cdot 10^{-3}</math>	160
8	<math> < 7 \cdot 10^{-3}</math>	120
10	<math> < 11 \cdot 10^{-3}</math>	90
12	<math> < 16 \cdot 10^{-3}</math>	80




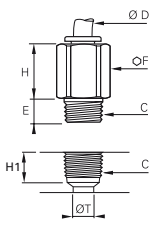

Self-Sealing and Oscillating Fittings

3391 Self-Sealing Stud Fitting, Male BSPP Thread

	Nickel-plated brass, NBR 	ØD C 	E	F	H	H1	H2	ØT	kg
		4 G1/8 3391 04 10	5	13	18	7.5	6	5	0.017
		6 G1/8 3391 06 10	5	14	19.5	9	6	7.5	0.019
		8 G1/8 3391 08 10	5	14	29.5	10	6	7.5	0.025
		8 G1/4 3391 08 13	5.5	16	25.5	11	8	9	0.032
		10 G3/8 3391 10 17	5.5	20	27.5	13	11	10	0.055


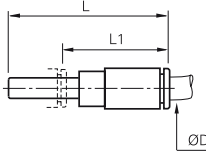

Maximum working pressure: 10 bar

3091 Self-Sealing Stud Fitting, Male BSPT Thread


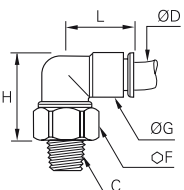

	Nickel-plated brass, NBR 	ØD C 	E	F	H	H1	ØT	kg
		4 R1/8 3091 04 10	7.5	12	18	9.5	5	0.015
		6 R1/8 3091 06 10	7.5	13	19.5	9.5	7.5	0.015
		8 R1/8 3091 08 10	6.5	14	25	10.5	7.5	0.024
		8 R1/4 3091 08 13	11	14	25.5	13.5	9	0.021
		10 R3/8 3091 10 17	11.5	17	27.5	14	10	0.035

Maximum working pressure: 10 bar
Pre-coated thread

3160 Self-Sealing Plug-In Fitting


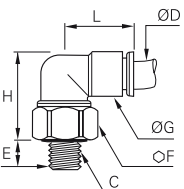

	Technical polymer, NBR 	ØD 	L	L1	kg
		4 3160 04 00	46	33.5	0.006
		6 3160 06 00	53.5	31	0.009
		8 3160 08 00	58	31	0.014

3159 Oscillating Elbow, Male BSPT Thread

	Technical polymer, nickel-plated brass, NBR 	ØD C 	F	G	H	L	kg
		4 R1/8 3159 04 10	12	11	22	17.5	0.012
		6 R1/8 3159 06 10	14	14	26.5	20.5	0.014
		6 R1/4 3159 06 13	14	14	23.5	20.5	0.022
		8 R1/8 3159 08 10	17	16	32	23.5	0.036
		8 R1/4 3159 08 13	17	16	29	23.5	0.037
		8 R3/8 3159 08 17	17	16	25	23.5	0.033
		10 R1/4 3159 10 13	19	19.5	37.5	29	0.053
		10 R3/8 3159 10 17	19	19.5	33.5	29	0.045
		12 R1/4 3159 12 13	21	22	44.5	33.5	0.080
		12 R3/8 3159 12 17	21	22	41	33.5	0.070

Pre-coated thread

3189 Oscillating Elbow, Male BSPP and Metric Thread

	Technical polymer, nickel-plated brass, NBR 	ØD C 	E	F	G	H	L	kg
		4 M5x0.8 3189 04 19	3	12	11	24.5	17.5	0.012
		4 G1/8 3189 04 10	5	13	11	23	17.5	0.013
		4 M5x0.8 3189 06 19	3	12	14	27.5	20.5	0.017
		6 G1/8 3189 06 10	5	14	14	27	20.5	0.019
		6 G1/4 3189 06 13	5.5	16	14	25.5	20.5	0.023
		6 G1/8 3189 08 10	5	17	16	33.5	23.5	0.034
		8 G1/4 3189 08 13	5.5	17	16	31	23.5	0.034
		8 G3/8 3189 08 17	5.5	20	16	29.5	23.5	0.042
		8 G1/4 3189 10 13	5.5	19	19.5	39	29	0.058
		10 G3/8 3189 10 17	5.5	20	19.5	37	29	0.050
		12 G1/4 3189 12 13	5.5	21	22	46.5	33.5	0.074
		12 G3/8 3189 12 17	5.5	21	22	45.5	33.5	0.072

Accessories for Push-In Fittings

Parker Legris has designed these different accessories to improve **safety** and circuit **identification**.

Product Advantages

Safety | Protection of operators and equipment
Prevents accidental disconnection
Disconnection only possible with tooling
Resistance to grease and cleaning agents

Ergonomic | Colour-coding for fluid circuit identification (6 colours)
Setting and fixing of your circuits thanks to clips and release button covers
Easy disconnection with tool where access is difficult
Adapted to meet all installation configurations



Robotics
Automotive Process
Pneumatics
Semi-Conductors
Textile
Water Treatment
Beverage Dispensers

Applications

Technical Characteristics

Compatible Ranges	LF 3000®, LIQUIfit®
Working Temperature	-20°C to +95°C
Materials	Tamper-proof safety clip, release button cover, clip: technical polymer Reducer and plug: nickel-plated brass

Installation Process

Tamper-Proof Safety Clip



Coloured Release Button Covers

Coloured release button covers can be mounted on LF 3000® and LIQUIfit® fittings, supplied fitted with manual release buttons.

5 colours are available and allows colour coding to be used throughout circuits.



Disconnection Tool

In cases where access is difficult, this tool can be particularly useful.



Clip Strips

Clips are also designed to fix LF 3000® fittings in series within a minimum of space.



The complete range of accessories can be found in Chapter 9.

Accessories for Push-In Fittings

3130 Tamper-Proof Safety Clip

Technical polymer	ØD							H	K	kg
	4	3130 04 01	3130 04 02	3130 04 03	3130 04 04	3130 04 05	3130 04 10	6.6	3	0.001
	6	3130 06 01	3130 06 02	3130 06 03	3130 06 04	3130 06 05	3130 06 10	7.8	3.1	0.001
	8	3130 08 01	3130 08 02	3130 08 03	3130 08 04	3130 08 05	3130 08 10	9.5	4.3	0.001
	10	3130 10 01	3130 10 02	3130 10 03	3130 10 04	3130 10 05	3130 10 10	10.8	4.2	0.002
	12	3130 12 01	3130 12 02	3130 12 03	3130 12 04	3130 12 05	3130 12 10	12.5	5.1	0.003
	14	3130 14 01	3130 14 02	3130 14 03	3130 14 04	3130 14 05	3130 14 10	15	6	0.004

CLIP Clip Strip for Tubes and Fittings

Technical polymer	ØD		H	K	N	kg
 	4	CLIP 04 00	9	13.5	10.5	0.007
	6	CLIP 06 00	10.5	13	10.5	0.004
	8	CLIP 08 00	12.5	10.5	12	0.007
	10	CLIP 10 00	14	12	15	0.005
	12	CLIP 12 00	16.5	14	16.5	0.009
	14	CLIP 14 00	18	16	20.5	0.008

Delivered in boxes of 10 strips of the same diameter (complete with selftapping screws of 95 mm length)

3000 Disconnection Tool

Treated steel	ØD	H	H1	L	kg
 	3000 70 00	25	20	96	0.021

For disconnecting LF 3000® tubing/fittings where access is difficult, we recommend the use of this disconnection tool.

3110 Coloured Release Button Covers

Technical polymer	ØD						kg
	4	3110 04 00	3110 04 02	3110 04 03	3110 04 04	3110 04 05	0.001
	6	3110 06 00	3110 06 02	3110 06 03	3110 06 04	3110 06 05	0.001
	8	3110 08 00	3110 08 02	3110 08 03	3110 08 04	3110 08 05	0.001
	10	3110 10 00	3110 10 02	3110 10 03	3110 10 04	3110 10 05	0.001
	12	3110 12 00	3110 12 02	3110 12 03	3110 12 04	3110 12 05	0.001
	14	3110 14 00	3110 14 02	3110 14 03	3110 14 04	3110 14 05	0.002

0178 Reducer, Male/Female BSP and Metric Thread

Nickel-plated brass, NBR	C1	C2		E	F	L	kg
 	M7x1	M5x0.8	0178 55 19	5	10	12	0.005
	G1/8	M5x0.8	0178 10 19	5	13	9	0.006
	G1/4	G1/8	0178 13 10	5.5	16	9.5	0.006
	G3/8	G1/8	0178 17 10	5.5	20	10.5	0.016
		G1/4	0178 17 13	5.5	20	10.5	0.011
	G1/2	G1/4	0178 21 13	7.5	24	12.5	0.024
		G3/8	0178 21 17	7.5	24	12.5	0.016
	G3/4	G1/2	0178 27 21	7.5	32	13.5	0.035

With integrated O-ring seal

0222 Internal Hex Plug, Male BSP and Metric Thread

Nickel-plated brass, NBR	C		E	F	F1	H	kg
 	M5x0.8	0222 19 00	3.5	8	2.5	7	0.002
	M7x1	0222 55 00	5	10	3	8.5	0.003
	G1/8	0222 10 00	5	13	5	8.5	0.006
	G1/4	0222 13 00	5.5	16	6	9.5	0.010
	G3/8	0222 17 00	5.5	20	8	10.5	0.019
	G1/2	0222 21 00	7.5	24	10	12	0.030

With integrated O-ring seal



LF 3200 (3 mm) Push-In Fittings Range

Stud Fittings

3281 Metric Page 1-41	3299 Metric Page 1-41	3229 Metric Page 1-41	3298 Metric Page 1-41	3293 Metric Page 1-41	3218 Metric Page 1-42
------------------------------------	------------------------------------	------------------------------------	------------------------------------	------------------------------------	------------------------------------



Tube-to-Tube Fittings and Accessories

3206 Straight Page 1-43	3202 Elbow Page 1-43	3204 Tee Page 1-43	3266 Reducer Page 1-43	3226 Plug Page 1-43
--------------------------------------	-----------------------------------	---------------------------------	-------------------------------------	----------------------------------



LF 3200 Push-In Fittings (3 mm)

Miniature pneumatic installations are very precise and sensitive systems, having specific operating characteristics. Consequently, Parker Legris has developed this **ergonomic** range of brass push-in fittings for its **mechanical robustness** and **compactness**.

Product Advantages

- Compact & Lightweight**
 - 25% smaller than other fittings on the market for optimum actuator dimensions
 - Minimum weight for maximum efficiency
 - Reduces energy consumption and limits actuator wear
- Resistance & Performance**
 - All brass components for excellent impact resistance
 - Gripping system with collet for increased robustness and service life
 - Excellent resistance to high operating pressures
- Reliability**
 - 100% leak-tested in production
 - Date coding to guarantee quality and traceability
 - Ideal for very sensitive applications
 - Corrosion-resistant



Applications

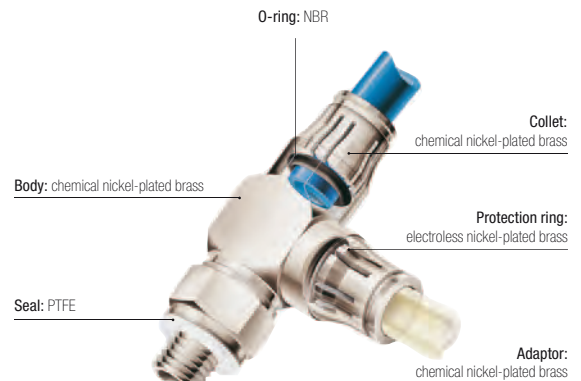
- Pneumatic Panels
- Robotics
- Semi-Conductors
- Textile
- Pneumatics
- Vacuum

Technical Characteristics

Compatible Fluids	Compressed air
Working Pressure	Vacuum to 20 bar
Working Temperature	-15°C to +80°C
Tightening Torque (daN.m)	0.01 to 0.1

Reliable performance is dependent upon the type of fluid conveyed, component materials and tubing being used. Use is guaranteed with a vacuum of 755 mm Hg (99% vacuum).

Component Materials



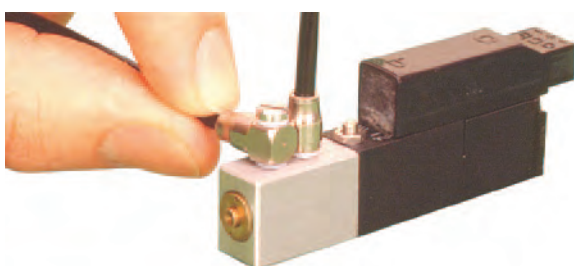
Silicone-free

Regulations

ISO 14743 ISO 14743: Pneumatic fluid power, push-in connectors for thermoplastic tubes

DI: 97/23/EC (PED)
DI: 2002/95/EC (RoHS), 2011/65/EC
DI: 94/9/EC (ATEX)
RG: 1907/2006 (REACH)

Installation Configurations


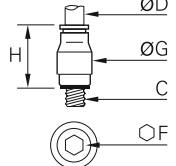



The LF 3200 fitting, connected with a 3 mm polyurethane or antistatic polyurethane tube, is the perfect solution for compact installations:


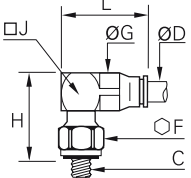

- which are highly stressed
- whose reliability is critical

Stud Fittings


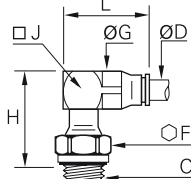

3281 Stud Fitting, Male Metric Thread

		Nickel-plated brass, NBR	ØD	C		F	G	H	kg	
			3	M3x0.5		3281 03 09	1.5	6	9.5	0.001
				M5x0.8		3281 03 19	1.5	8	9.5	0.002


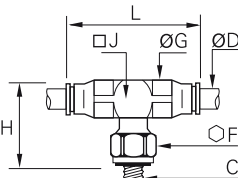

3299 Compact Stud Elbow, Male Metric Thread

		Nickel-plated brass, NBR	ØD	C		F	G	H	J	L	kg	
			3	M3x0.5		3299 03 09	6	6	13.5	6	13.5	0.004
				M5x0.8		3299 03 19	8	6	13	6	13.5	0.005


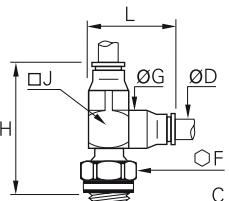

3229 Extended Stud Elbow, Male Metric Thread

		Nickel-plated brass, NBR	ØD	C		F	G	H	J	L	kg	
			3	M3x0.5		3229 03 09	6	6	16	6	13.5	0.004
				M5x0.8		3229 03 19	8	6	17	6	13.5	0.005

3298 Stud Branch Tee, Male Metric Thread


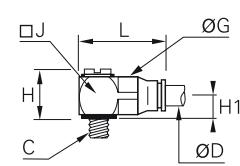

		Nickel-plated brass, NBR	ØD	C		F	G	H	J	L	kg	
			3	M3x0.5		3298 03 09	6	6	13.5	6	20.5	0.004
				M5x0.8		3298 03 19	8	6	13	6	20.5	0.005

3293 Stud Run Tee, Male Metric Thread

		Nickel-plated brass, NBR	ØD	C		F	G	H	J	L	kg	
			3	M3x0.5		3293 03 09	6	6	20	6	13.5	0.004
				M5x0.8		3293 03 19	8	6	20	6	13.5	0.005


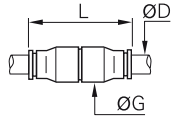

Stud Fittings

3218 Single Banjo, Male Metric Thread


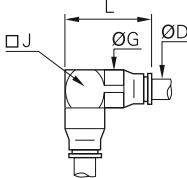

	Nickel-plated brass, NBR 	ØD	C		G	H	H1	J	L	kg
		3	M3x0.5	3218 03 09	6	9.5	4	6	12.5	0.002
			M5x0.8	3218 03 19	6	10.5	4.5	8	15	0.005

Tube-to-Tube Fittings and Accessories


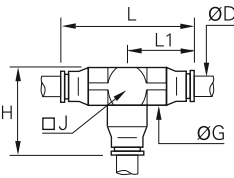

3206 Equal Tube-to-Tube Connector

	Nickel-plated brass, NBR		ØD		G	L	kg
			3	3206 03 00	6	17	0.002


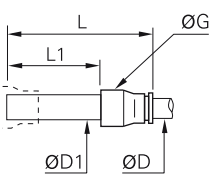

3202 Equal Elbow

	Nickel-plated brass, NBR		ØD		G	J	L	kg
			3	3202 03 00	6	6	13.5	0.003


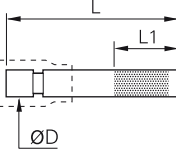

3204 Equal Tee

	Nickel-plated brass, NBR		ØD		G	H	J	L	L1	kg
			3	3204 03 00	6	13.5	6	20.5	10.25	0.004

3266 Plug-In Reducer

	Nickel-plated brass, NBR, technical polymer		ØD	ØD1		G	L	L1	kg
			3	4	3266 03 04	6	28	19	0.001

3226 Blanking Plug

	Nickel-plated brass		ØD		L	L1	kg
			3	3226 03 00	20	10	0.001

Range of LIQUIfit® Push-In Fittings

Stud Fittings										
Straights				Straights - Inch						Carstick®
6505 BSPT Page 1-48	6315 BSPT Page 1-48	6353 BSPP Page 1-49	6521 BSPT Page 1-50	6505 NPTF/BSPT Page 1-48	6315 NPTF Page 1-49	6353 BSPP Page 1-49	6352 BSPP Page 1-49	6325 UNS Page 1-49	6521 NPTF/BSPT Page 1-50	6300 Page 1-50
Carstick® - Inch	Elbows		Elbows - Inch		Tees		Tees - Inch		Plugs	
6300 Page 1-50	6579 BSPT Page 1-51	6509 BSPT Page 1-51	6579 BSPT/NPTF Page 1-51	6509 BSPT/NPTF Page 1-52	6508 BSPT Page 1-52	6503 BSPT Page 1-53	6508 BSPT/NPTF Page 1-53	6503 BSPT/NPTF Page 1-53	6355 BSPT Page 1-53	

Tube-to-Tube Fittings					
Straight	Straight - Inch	Elbow	Elbow - Inch	Tee	Tee - Inch
6306 Page 1-54	6306 Page 1-54	6302 Page 1-54	6302 Page 1-54	6304 Page 1-55	6304 Page 1-55
Y	Y - Inch	Cross	Cross - Inch		
6340 Page 1-55	6340 Page 1-55	6307 Page 1-56	6307 Page 1-56		

Bulkhead Connectors	
Straight	Straight - Inch
6316 Page 1-56	6316 Page 1-56

Plug-In Fittings and Accessories					
Elbows		Elbow - Inch	Tees		Tee - Inch
6382 Page 1-57	6380 Page 1-57	6382 Page 1-57	6383 Page 1-57	6388 Page 1-57	6388 Page 1-58
Accessories			Accessories - Inch		
6366 Page 1-58	6326 Page 1-58	6322 Page 1-59	6351 Page 1-59	6366 Page 1-58	6368 Page 1-58

Range of LIQUIfit+ Push-In Fittings

Stud Fittings

Straight - Inch

6333

Page 1-63



Tube-to-Tube Fittings

Straight - Inch

6336

Page 1-63



Elbow - Inch

6332

Page 1-63



Plug-In Fittings

Elbow - Inch

6331

Page 1-63



LIQUIfit® and LIQUIfit+ Accessories

3130

Page 1-60

3110

Page 1-60

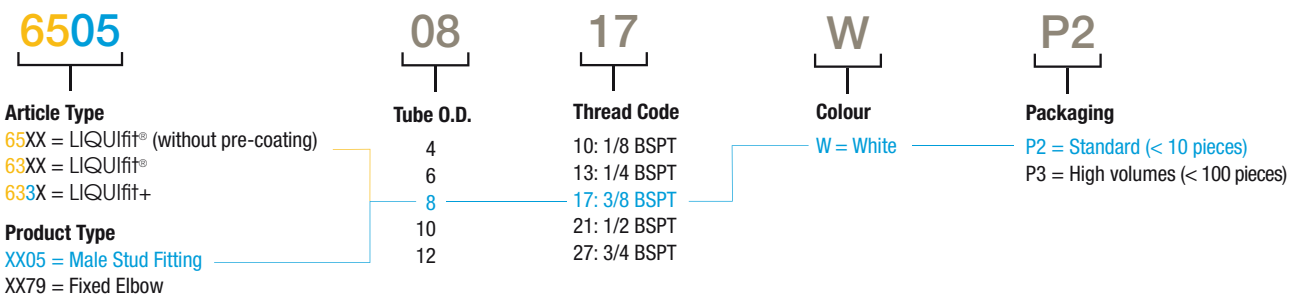
0605

Page 1-60



Part Number Construction

Example: **6505 08 17WP2**



LIQUIfit® Push-In Fittings

This "eco-designed" range proposes an **innovative alternative** for water applications; **no fluid contamination** occurs and **environmental protection is guaranteed**. These fittings ensure **reliable and compact** connections for **liquid transfer** applications.

Product Advantages

Innovative Technology & Concept

- Ergonomic and aesthetic design
- The most compact product on the market for water, beverages and liquid foodstuffs
- Easy-to-clean external surfaces
- Push-in connection and disconnection
- Full flow
- Use with a pre-prepared metallic tubing
- Gripping system preventing any pumping effect
- Eco-designed (materials, manufacturing process, weight, dimensions and performance)

Optimal Performance

- Patented sealing technology
- 100% leak-tested in production
- Date coding to guarantee quality and traceability
- Wide range of shapes and numerous configurations

High Performance Material

- Bio-sourced polymer meeting the most severe food process regulations
- Suitable for contact with water and beverages
- Excellent chemical and mechanical resistance, even at high temperature
- Free of bisphenol A and phtalates, conforming with regulations



- Hot & Cold Drinks Dispensers
- Neutral Gases
- Cooling Systems
- Food Process
- Water Purification Systems
- Water Dispensers
- Medical

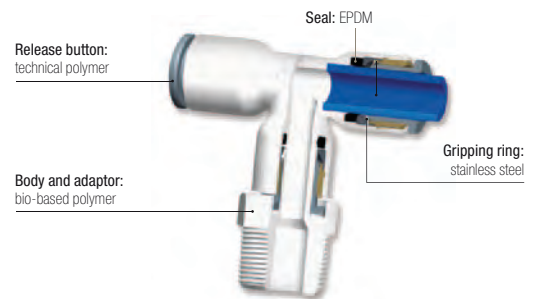
Applications

Technical Characteristics

Compatible Fluids	Water, beverages, CO ₂ (inert use) Chemical fluids: please consult us		
Working Pressure	Vacuum to 16 bar		
Working Temperature	-10°C to +95°C		
Tightening Torques (BSPT/NPTF)	Thread	1/8" and 1/4"	3/8" and 1/2"
	daN.m	0.15	0.30

Reliable performance is dependent upon the type of fluid conveyed, component materials and tubing being used. Use is guaranteed with a vacuum of 755 mm Hg (99% vacuum).

Component Materials



Silicone-free

Regulations

- | | |
|-----------------------------------|---------------------------|
| DI: 2002/95/EC (RoHS), 2011/65/EC | DM 174 |
| RG: 1935/2004/EC | KTW: fittings, on request |
| FDA: 21 CFR | WRAS |
| NSF 51 at 95°C | ACS |
| NSF/ANSI 61 - C HOT | |

Pressure and Temperature of the Different Diameters and Related Products of the LIQUIfit® Range

-10°C		Pressure (bar)	
mm Ø	inch Ø	Fittings	Tubing
4	5/32	16	16
6	1/4	16	16
8	5/16	16	16
10	3/8	13	15
12	1/2	11	11

+1°C		Pressure (bar)	
mm Ø	inch Ø	Fittings	Tubing
4	5/32	16	16
6	1/4	16	16
8	5/16	16	16
10	3/8	13	15
12	1/2	11	11

+20°C		Pressure (bar)	
mm Ø	inch Ø	Fittings	Tubing
4	5/32	16	16
6	1/4	16	16
8	5/16	16	16
10	3/8	13	15
12	1/2	11	11

+40°C		Pressure (bar)	
mm Ø	inch Ø	Fittings	Tubing
4	5/32	16	16
6	1/4	16	16
8	5/16	16	16
10	3/8	13	15
12	1/2	11	11

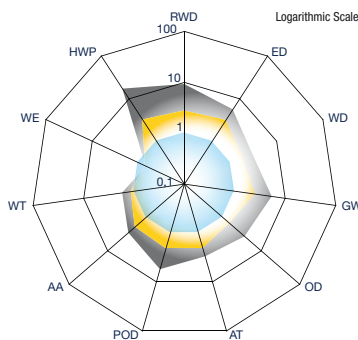
+65°C		Pressure (bar)	
mm Ø	inch Ø	Fittings	Tubing
4	5/32	10	10
6	1/4	10	10
8	5/16	10	10
10	3/8	7	7
12	1/2	7	7

+95°C		Pressure (bar)	
mm Ø	inch Ø	Fittings	Tubing
4	5/32	4	4
6	1/4	4	4
8	5/16	4	4
10	3/8	4	4
12	1/2	4	4

LIQUIfit®

Environmental Footprint

Example: representation of the environmental footprint of an equal tube-to-tube connector



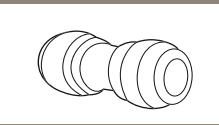
Double Union
 ■ Market Standard in POM
 ■ Market Standard in PP
 ■ PARKER LEGRIS

LIQUIfit® Tube-to-Tube Connector



Market Standard

Tube-to-Tube Connector



Environmental Approach

The Life Cycle Analysis (LCA) offers a true alternative in terms of environmental differentiation.

We carried out a comparative LCA on the market of drinking water between 3 Parker Legris fittings and the standard products on the market.

This analysis relies on ISO 14020, ISO 14025 and IEC PAS 62545 standards and the results are presented in a report approved by an ethics committee (Bureau Veritas).


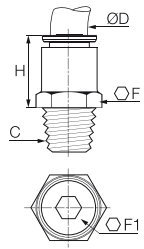




RWD: Raw Material Depletion
 ED: Energy Depletion
 WD: Water Depletion
 GW: Global Warming
 OZ: Ozone Depletion
 AT: Air Toxicity

POC: Photochemical Ozone Creation
 AA: Air Acidification
 WT: Water Toxicity
 WE: Water Eutrophication
 HWP: Hazardous Waste Production

Stud Fittings


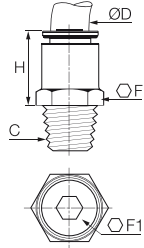


6505 Stud Fitting, Male BSPT Thread

	Bio-based polymer, EPDM			ØD	C		F	F1	H	kg
	4	R1/8	6505 04 10WP2	11	3	18	0.003			
		R1/4	6505 04 13WP2	14	3	18	0.004			
	6	R1/8	6505 06 10WP2	11	4	18	0.002			
		R1/4	6505 06 13WP2	14	4	18	0.004			
	8	R1/8	6505 08 10WP2	17	6	20	0.004			
		R1/4	6505 08 13WP2	14	6	20	0.004			
	10	R1/4	6505 10 13WP2	17	7	21.5	0.005			
		R3/8	6505 10 17WP2	19	7	21.5	0.007			
	12	R1/2	6505 10 21WP2	22	7	21.5	0.010			
		R3/8	6505 12 17WP2	19	9	24.5	0.008			
		R1/2	6505 12 21WP2	22	9	24.5	0.012			

These part numbers are also available in WP3 = high volumes (number of parts per bag: 40, 50 or 100, depending on the diameters).
Thread without pre-coating.

6505 Stud Fitting, Male NPTF Thread


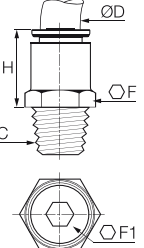


Inch

	Bio-based polymer, EPDM			ØD	C		F	F1	H	kg
	1/4	NPT1/8	6505 56 11WP2	1/2	5/32	17	0.002			
		NPT1/4	6505 56 14WP2	9/16	5/32	17	0.003			
		NPT3/8	6505 56 18WP2	3/4	1/4	21.5	0.004			
	3/8	NPT1/8	6505 60 11WP2	3/4	5/32	22.1	0.005			
		NPT1/4	6505 60 14WP2	3/4	1/4	22	0.006			
		NPT3/8	6505 60 18WP2	3/4	1/4	22	0.007			
	1/2	NPT1/2	6505 60 22WP2	15/16	1/4	27	0.012			
		NPT3/8	6505 62 18WP2	15/16	3/8	28	0.012			
		NPT1/2	6505 62 22WP2	15/16	3/8	28	0.013			

These part numbers are also available in WP3 = high volumes (number of parts per bag: 40, 50 or 100, depending on the diameters).
Thread without pre-coating.
6505 56 18WP3, 6505 60 11WP3 and 6505 60 22WP3 are also available.


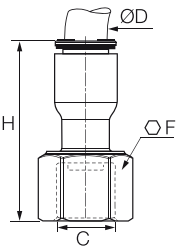


6505 Stud Fitting, Male BSPT Thread

Inch

	Bio-based polymer, EPDM			ØD	C		F	F1	H	kg
	1/4	R1/8	6505 56 10WP2	11	5	17	0.002			
		R1/4	6505 56 13WP2	14	5	17	0.003			
		R1/4	6505 60 13WP2	17	7	22	0.006			
	3/8	R3/8	6505 60 17WP2	19	7	22	0.006			
		R1/2	6505 60 21WP2	22	7	28	0.012			
		R1/2	6505 62 21WP2	24	9	28	0.014			

These part numbers are also available in WP3 = high volumes (number of parts per bag: 40, 50 or 100, depending on the diameters).
5/32" (4 mm) and 5/16" (8 mm) also available.
Thread without pre-coating.

6315 Stud Fitting, Female BSPT Thread


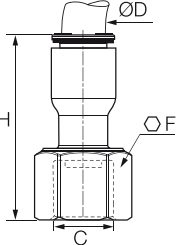

	Bio-based polymer, EPDM			ØD	C		F	H	kg
	6	R1/8	6315 06 10WP2	13	32	0.003			
		R1/4	6315 06 13WP2	16	33	0.004			
	8	R1/4	6315 08 13WP2	16	33.5	0.004			
		R3/8	6315 08 17WP2	20	36	0.009			

These part numbers are also available in WP3 = high volumes (number of parts per bag: 40, 50 or 100, depending on the diameters).

Stud Fittings


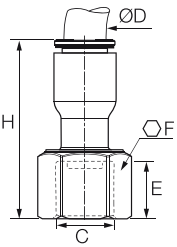

6315 Stud Fitting, Female NPTF Thread

Inch

		Bio-based polymer, EPDM			ØD C F H kg		
		1/4	NPT1/4	6315 56 14WP2	11/16	30	0.003
		3/8	NPT3/8	6315 60 18WP2	13/16	36	0.007

These part numbers are also available in WP3 = high volumes (number of parts per bag: 40, 50 or 100, depending on the diameters).


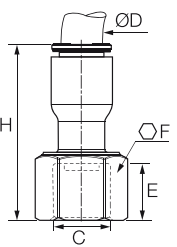

6353 Tap Connector Cone Type, Female BSPP Thread

		Bio-based polymer, EPDM			ØD C E F H kg			
		6	G3/4	6353 06 27WP2	10	32	32	0.011
		8	G3/4	6353 08 27WP2	10	32	40.5	0.017
		10	G1/2	6353 10 21WP2	12	27	36	0.011

These part numbers are also available in WP3 = high volumes (number of parts per bag: 40, 50 or 100, depending on the diameters).

6353 Tap Connector Cone Type, Female BSPP Thread


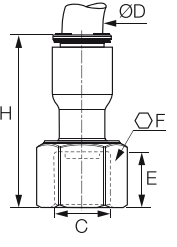

Inch

		Bio-based polymer, EPDM			ØD C E F H kg			
		1/4	G3/4	6353 56 27WP2	10	32	31	0.006
		3/8	G1/2	6353 60 21WP2	12	27	36	0.011
			G3/4	6353 60 27WP2	10	32	41	0.018
		1/2	G3/4	6353 62 27WP2	10	32	44.5	0.014

These part numbers are also available in WP3 = high volumes (number of parts per bag: 40, 50 or 100, depending on the diameters).

6352 Stud Fitting Flat Type, Female BSPP Thread


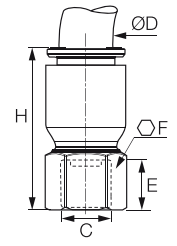

Inch

		Bio-based polymer, EPDM			ØD C E F H kg			
		5/16	G1/2	6352 08 21WP2	10.5	27	37	0.009
		3/8	G5/8	6352 08 23WP2	10.5	29	32	0.013
			G3/8	6352 60 17WP2	12	22	36	0.008
		1/2	G1/2	6352 60 21WP2	12	27	36	0.011
			G5/8	6352 62 23WP2	10.5	29	32	0.013

These part numbers are also available in WP3 = high volumes (number of parts per bag: 40, 50 or 100, depending on the diameters).

6325 Faucet Connector, Female UNS Thread

Inch

		Bio-based polymer, EPDM			ØD C E F H kg			
		1/4	UNS7/16-24	6325 56 133WP2	7	9/16	31	0.002
		3/8	UNS7/16-24	6325 60 133WP2	7	9/16	32	0.004

These part numbers are also available in WP3 = high volumes (number of parts per bag: 40, 50 or 100, depending on the diameters).

Stud Fittings

6521 Stud Standpipe, Male BSPT Thread

	Bio-based polymer		ØD	C		F	H	kg
			6	R1/8	6521 06 10WP2	13	19	0.002
			R1/4	6521 06 13WP2	14	19	0.003	
			R3/8	6521 06 17WP2	17	19	0.004	
			8	R1/8	6521 08 10WP2	19	23	0.003
			R1/4	6521 08 13WP2	19	23	0.004	
			R3/8	6521 08 17WP2	19	23	0.004	
			10	R1/4	6521 10 13WP2	19	25	0.004
			R3/8	6521 10 17WP2	19	25	0.005	
			R1/2	6521 10 21WP2	22	25	0.008	
			12	R3/8	6521 12 17WP2	22	28	0.005
R1/2	6521 12 21WP2	22	28	0.007				

These part numbers are also available in WP3 = high volumes (number of parts per bag: 40, 50 or 100, depending on the diameters).
Thread without pre-coating.

6521 Stud Standpipe, Male NPTF Thread

Inch

	Bio-based polymer		ØD	C		F	H	kg
			1/4	NPT1/8	6521 56 11WP2	1/2	19	0.001
			NPT1/4	6521 56 14WP2	1/2	19	0.002	
			NPT3/8	6521 56 18WP2	3/4	19.5	0.004	
			3/8	NPT1/4	6521 60 14WP2	3/4	25	0.004
			NPT3/8	6521 60 18WP2	3/4	25	0.004	
			1/2	NPT3/8	6521 62 18WP2	15/16	31	0.010
NPT1/2	6521 62 22WP2	15/16	32.5	0.013				

These part numbers are also available in WP3 = high volumes (number of parts per bag: 40, 50 or 100, depending on the diameters).
Thread without pre-coating.

6521 Stud Standpipe, Male BSPT Thread

Inch

	Bio-based polymer		ØD	C		F	H	kg
			1/4	R1/8	6521 56 10WP2	14	19	0.001
			R1/4	6521 56 13WP2	14	19	0.002	
			R3/8	6521 56 17WP2	17	19	0.004	
			3/8	R1/4	6521 60 13WP2	19	25	0.004
			R3/8	6521 60 17WP2	19	25	0.004	
			1/2	R3/8	6521 62 17WP2	24	31.5	0.006
R1/2	6521 62 21WP2	24	31.5	0.009				

These part numbers are also available in WP3 = high volumes (number of parts per bag: 40, 50 or 100, depending on the diameters). 5/32" (4 mm) and 5/16" (8 mm) also available.
Thread without pre-coating.

6300 LIQUIfit® Cartridge

	Brass, EPDM		ØD		G	H	kg
			4	6300 04 00	8	10	0.002
			6	6300 06 00	10	11.5	0.002
			8	6300 08 00	13	15	0.003
			10	6300 10 00	15.5	17	0.005
			12	6300 12 00	18.5	19.5	0.010
			50 cartridges per Carstick® Cavity dimensions are available in Chapter 2.				


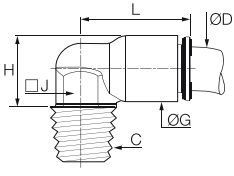

6300 LIQUIfit® Cartridge

Inch

	Brass, EPDM		ØD		G	H	kg
			1/4	6300 56 00	10.5	12.5	0.002
			3/8	6300 60 00	15.5	17	0.005
			1/2	6300 62 00	22	23	0.011
50 cartridges per Carstick® 5/32" (4 mm) and 5/16" (8 mm) also available. Cavity dimensions are available in Chapter 2.							


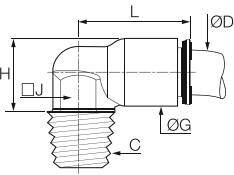

Stud Fittings

6579 Fixed Elbow, Male BSPT Thread

		Bio-based polymer, EPDM	ØD C 	G H J L kg
			6 R1/8 6579 06 10WP2	11 14 10 19 0.002
			R1/4 6579 06 13WP2	11 14 10 19 0.003
			R3/8 6579 06 17WP2	11 14 10 19 0.004


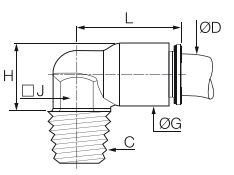

These part numbers are also available in WP3 = high volumes (number of parts per bag: 40, 50 or 100, depending on the diameters).
Thread without pre-coating.

6579 Fixed Elbow, Male NPTF Thread Inch

		Bio-based polymer, EPDM	ØD C 	G H J L kg
			1/4 NPT1/8 6579 56 11WP2	11 22 3/8 18 0.009
			NPT1/4 6579 56 14WP2	11 26 3/8 18 0.003
			NPT3/8 6579 56 18WP2	11 26.5 3/8 18 0.004


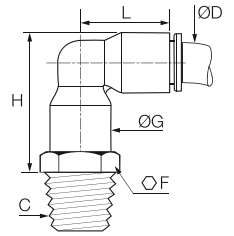

These part numbers are also available in WP3 = high volumes (number of parts per bag: 40, 50 or 100, depending on the diameters).
Thread without pre-coating.

6579 Fixed Elbow, Male BSPT Thread Inch

		Bio-based polymer, EPDM	ØD C 	G H J L kg
			1/4 R1/8 6579 56 10WP2	11 22 10 18 0.002
			R1/4 6579 56 13WP2	11 26 10 18 0.003
			R3/8 6579 56 17WP2	11 26 10 18 0.004

These part numbers are also available in WP3 = high volumes (number of parts per bag: 40, 50 or 100, depending on the diameters).
Thread without pre-coating.

6509 Stud Elbow, Male BSPT Thread

		Bio-based polymer, EPDM	ØD C 	F G H L kg
			6 R1/8 6509 06 10WP2	13 10.5 28 24 0.037
			R1/4 6509 06 13WP2	14 10.5 28 24 0.007
			R3/8 6509 06 17WP2	17 10.5 28 24 0.008
			8 R1/8 6509 08 10WP2	19 13.5 34 29.5 0.010
			R1/4 6509 08 13WP2	19 13.5 34 29.5 0.011
			R3/8 6509 08 17WP2	19 13.5 34 29.5 0.011
			10 R1/4 6509 10 13WP2	19 16 38 34.5 0.019
			R3/8 6509 10 17WP2	19 16 38 34.5 0.020
			R1/2 6509 10 21WP2	22 16 38 34.5 0.023
			12 R3/8 6509 12 17WP2	22 19 44 40 0.022
			R1/2 6509 12 21WP2	22 19 44 40 0.024

These part numbers are also available in WP3 = high volumes (number of parts per bag: 40, 50 or 100, depending on the diameters).
Thread without pre-coating; the body swivels for positioning purposes.

Complementary LIQUIfit® Range Products

The other LIQUIfit® range products are presented in the corresponding chapters of this catalogue:

Technical Tubing and Hose

Advanced PE

P. 3-26



Function Fittings

Non-Return Valves

P. 4-44



Industrial Ball Valves

LIQUIfit® Ball Valves



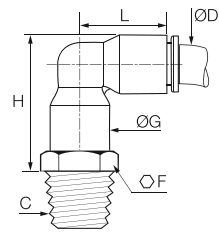
P. 6-34



Stud Fittings

6509 Elbow, Male NPTF Thread



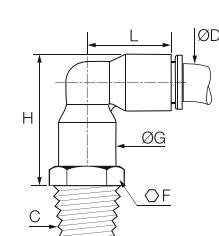
Inch

Bio-based polymer, EPDM		ØD	C		F	G	H	L	kg	
		NPT1/8	6509 56	11WP2	1/2	11	28	23.5	0.003	
		1/4	NPT1/4	6509 56	14WP2	9/16	11	28	23.5	0.004
		NPT3/8	6509 56	18WP2	3/4	11	28.5	23.5	0.006	
3/8		NPT1/4	6509 60	14WP2	3/4	16	38	34	0.010	
		NPT3/8	6509 60	18WP2	3/4	16	38	34	0.011	
1/2		NPT3/8	6509 62	18WP2	15/16	22	50.5	46.5	0.024	
		NPT1/2	6509 62	22WP2	15/16	22	51.5	46.5	0.027	

These part numbers are also available in WP3 = high volumes (number of parts per bag: 40, 50 or 100, depending on the diameters).
Thread without pre-coating; the body swivels for positioning purposes.



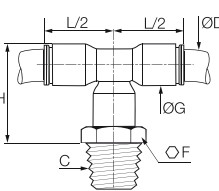
6509 Elbow, Male BSPT Thread

Inch

Bio-based polymer, EPDM		ØD	C		F	G	H	L	kg	
		R1/8	6509 56	10WP2	14	11	28	23.5	0.003	
		1/4	R1/4	6509 56	13WP2	14	11	28	23.5	0.004
		R3/8	6509 56	17WP2	17	11	28	23.5	0.006	
3/8		R1/4	6509 60	13WP2	19	16	38	34	0.010	
		R3/8	6509 60	17WP2	19	16	38	34	0.011	
1/2		R3/8	6509 62	17WP2	24	22	50.5	46.5	0.024	
		R1/2	6509 62	21WP2	24	22	50.5	46.5	0.027	

These part numbers are also available in WP3 = high volumes (number of parts per bag: 40, 50 or 100, depending on the diameters). 5/32" (4 mm) and 5/16" (8 mm) also available.
Thread without pre-coating; the body swivels for positioning purposes.



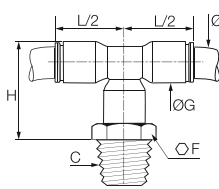
6508 Branch Tee, Male BSPT Thread

Bio-based polymer, EPDM		ØD	C		F	G	H	L/2	kg		
		6	R1/8	6508 06	10WP2	13	10.5	28	18	0.008	
			R1/4	6508 06	13WP2	14	10.5	28	18	0.009	
			R3/8	6508 06	17WP2	17	10.5	28	18	0.010	
		8		R1/8	6508 08	10WP2	19	13.5	34	23	0.012
				R1/4	6508 08	13WP2	19	13.5	34	23	0.013
				R3/8	6508 08	17WP2	19	13.5	34	23	0.013
		10		R1/4	6508 10	13WP2	19	16	38	26.5	0.018
				R3/8	6508 10	17WP2	19	16	38	26.5	0.019
				R1/2	6508 10	21WP2	22	16	38	26.5	0.022
		12		R3/8	6508 12	17WP2	22	19	44	31	0.024
				R1/2	6508 12	21WP2	22	19	44	31	0.026

These part numbers are also available in WP3 = high volumes (number of parts per bag: 40, 50 or 100, depending on the diameters).
Thread without pre-coating; the body swivels for positioning purposes.

6508 Branch Tee, Male NPTF Thread

Inch


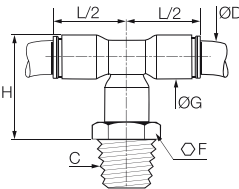

Bio-based polymer, EPDM		ØD	C		F	G	H	L/2	kg		
		1/4	NPT1/8	6508 56	11WP2	1/2	11	28	18	0.004	
			NPT1/4	6508 56	14WP2	9/16	11	28	18	0.005	
			NPT3/8	6508 56	18WP2	3/4	11	29	18	0.007	
		3/8		NPT1/4	6508 60	14WP2	3/4	16	38	26	0.013
				NPT3/8	6508 60	18WP2	3/4	16	38	26	0.013
		1/2		NPT3/8	6508 62	18WP2	15/16	22	50	35.5	0.031
				NPT1/2	6508 62	22WP2	15/16	22	51	35.5	0.034

These part numbers are also available in WP3 = high volumes (number of parts per bag: 40, 50 or 100, depending on the diameters).
Thread without pre-coating; the body swivels for positioning purposes.

Stud Fittings


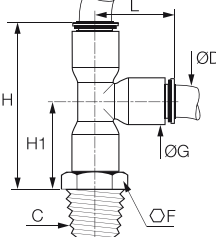

6508 Branch Tee, Male BSPT Thread

Inch

 	Bio-based polymer, EPDM		ØD	C		F	G	H	L/2	kg
	R1/8	6508 56 10WP2	13	11	28	18	0.004			
	R1/4	6508 56 13WP2	14	11	28	18	0.005			
	R3/8	6508 56 17WP2	17	11	28	18	0.007			
	R1/4	6508 60 13WP2	19	16	38	26	0.013			
	R3/8	6508 60 17WP2	19	16	38	26	0.013			
	R3/8	6508 62 17WP2	24	22	50	35.5	0.032			
	R1/2	6508 62 21WP2	24	22	50	35.5	0.032			

These part numbers are also available in WP3 = high volumes (number of parts per bag: 40, 50 or 100, depending on the diameters). 5/32" (4 mm) and 5/16" (8 mm) also available.
Thread without pre-coating; the body swivels for positioning purposes.


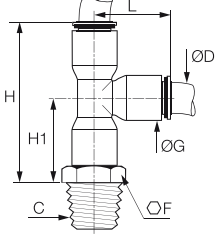

6503 Run Tee, Male BSPT Thread

 	Bio-based polymer, EPDM		ØD	C		F	G	H	H1	L	kg
	R1/8	6503 06 10WP2	13	10.5	40	22	18.5	0.008			
	R1/4	6503 06 13WP2	14	10.5	40	22	18.5	0.009			
	R3/8	6503 06 17WP2	17	10.5	40	22	18.5	0.010			
	R1/8	6503 08 10WP2	19	13.5	50	27	23	0.012			
	R1/4	6503 08 13WP2	19	13.5	50	27	23	0.013			
	R3/8	6503 08 17WP2	19	13.5	50	27	23	0.013			
	R1/4	6503 10 13WP2	19	16	56.5	30	26.5	0.018			
	R3/8	6503 10 17WP2	19	16	56.5	30	26.5	0.019			
	R1/2	6503 10 21WP2	22	16	56.5	30	26.5	0.022			
R3/8	6503 12 17WP2	22	19	65.5	34.5	31	0.024				
R1/2	6503 12 21WP2	22	19	65.5	34.5	31	0.026				

These part numbers are also available in WP3 = high volumes (number of parts per bag: 40, 50 or 100, depending on the diameters).
Thread without pre-coating; the body swivels for positioning purposes.

6503 Run Tee, Male NPTF Thread


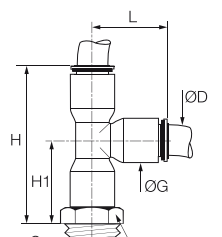

Inch

 	Bio-based polymer, EPDM		ØD	C		F	G	H	H1	L	kg
	NPT1/8	6303 56 11WP2	1/2	11	40.5	22.5	18	0.004			
	NPT1/4	6503 56 14WP2	9/16	11	40.5	22.5	18	0.005			
	NPT3/8	6503 56 18WP2	3/4	11	41.5	23	18	0.007			
	NPT1/4	6503 60 14WP2	3/4	16	56	30	26	0.013			
	NPT3/8	6503 60 18WP2	3/4	16	56	30	26	0.013			
	NPT3/8	6503 62 18WP2	15/16	22	75	39.5	35.5	0.031			
	NPT1/2	6503 62 22WP2	15/16	22	76	40.5	35.5	0.035			

These part numbers are also available in WP3 = high volumes (number of parts per bag: 40, 50 or 100, depending on the diameters).
Thread without pre-coating; the body swivels for positioning purposes.


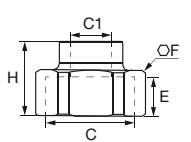

6503 Run Tee, Male BSPT Thread

Inch

 	Bio-based polymer, EPDM		ØD	C		F	G	H	H1	L	kg
	R1/8	6503 56 10WP2	13	11	41.5	22.5	18	0.004			
	R1/4	6503 56 13WP2	14	11	41.5	22.5	18	0.005			
	R3/8	6503 56 17WP2	17	11	41.5	23	18	0.007			
	R1/4	6503 60 13WP2	19	16	56	30	26	0.013			
	R3/8	6503 60 17WP2	19	16	56	30	26	0.013			
	R3/8	6503 62 17WP2	24	22	75	39.5	35.5	0.032			
	R1/2	6503 62 21WP2	24	22	75	39.5	35.5	0.035			

These part numbers are also available in WP3 = high volumes (number of parts per bag: 40, 50 or 100, depending on the diameters). 5/32" (4 mm) and 5/16" (8 mm) also available.
Thread without pre-coating; the body swivels for positioning purposes.



6355 Unequal Connector, Female BSPP Thread

 	Bio-based polymer		C	C1		E	F	H	kg
	G3/4	G1/4	6355 13 27WP2	10	32	23.5	0.050		

These part numbers are also available in WP3 = high volumes (number of parts per bag: 40, 50 or 100, depending on the diameters).



Tube-to-Tube Fittings

6306 Equal and Unequal Tube-to-Tube Connector

Bio-based polymer, EPDM		ØD	ØD1		G	L	kg
4		4	4	6306 04 00WP2	8.5	26.5	0.002
			6	6306 04 06WP2	10.5	29	0.002
			8	6306 04 08WP2	13.5	37	0.005
6		6	6	6306 06 00WP2	10.5	30	0.004
			8	6306 06 08WP2	13.5	37	0.005
			10	6306 06 10WP2	16	42	0.007
8		8	8	6306 08 00WP2	13.5	37	0.004
			10	6306 08 10WP2	16	42	0.007
			12	6306 08 12WP2	19	50	0.012
10		10	10	6306 10 00WP2	16	42	0.009
			12	6306 10 12WP2	19	50	0.013
			12	6306 12 00WP2	19	50.5	0.009



These part numbers are also available in WP3 = high volumes (number of parts per bag: 40, 50 or 100, depending on the diameters).

6306 Equal and Unequal Tube-to-Tube Connector Inch

Bio-based polymer, EPDM		ØD	ØD1		G	L	kg
5/16		3/8	3/8	6306 08 60WP2	16	42	0.008
			1/2	6306 08 62WP2	22	55	0.018
1/4		1/4	5/16	6306 56 00WP2	11	30	0.002
			3/8	6306 56 08WP2	13.5	37	0.007
3/8		3/8	3/8	6306 60 00WP2	16	41	0.007
			1/2	6306 60 62WP2	22	56	0.020
1/2		1/2	1/2	6306 62 00WP2	22	57	0.016



These part numbers are also available in WP3 = high volumes (number of parts per bag: 40, 50 or 100, depending on the diameters).

6302 Equal and Unequal Elbow

Bio-based polymer, EPDM		ØD	ØD1		G	L	kg
4		4	4	6302 04 00WP2	8.5	19	0.002
			6	6302 04 06WP2	10.5	24	0.004
6		6	6	6302 06 00WP2	10.5	24	0.004
			8	6302 06 08WP2	13.5	29.5	0.006
8		8	8	6302 08 00WP2	13.5	29	0.004
			10	6302 08 10WP2	16	34.5	0.008
10		10	10	6302 10 00WP2	16	34.5	0.005
			12	6302 10 12WP2	19	40.5	0.013
12		12	12	6302 12 00WP2	19	40.5	0.010

These part numbers are also available in WP3 = high volumes (number of parts per bag: 40, 50 or 100, depending on the diameters).


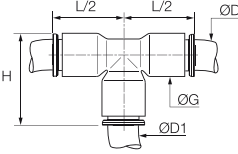

6302 Equal and Unequal Elbow Inch

Bio-based polymer, EPDM		ØD	ØD1		G	L	kg
5/16		3/8	3/8	6302 08 60WP2	16	34	0.009
			1/4	6302 56 00WP2	11	24	0.005
1/4		1/4	5/16	6302 56 08WP2	13.5	29.5	0.006
			3/8	6302 56 60WP2	16	34	0.008
3/8		3/8	3/8	6302 60 00WP2	16	34	0.006
			1/2	6302 60 62WP2	22	46.5	0.011
1/2		1/2	1/2	6302 62 00WP2	22	46.5	0.017

These part numbers are also available in WP3 = high volumes (number of parts per bag: 40, 50 or 100, depending on the diameters).

Tube-to-Tube Fittings


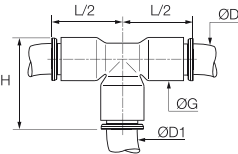

6304 Equal Tee

		Bio-based polymer, EPDM			ØD	ØD1		G	H	L/2	kg
		4	4	6304 04 00WP2	8.5	20	15.5	0.004			
		6	6	6304 06 00WP2	10.5	23	18	0.006			
		8	8	6304 08 00WP2	13.5	29	22.5	0.006			
		10	10	6304 10 00WP2	16	34.5	26.5	0.009			
		12	12	6304 12 00WP2	19	40	31	0.014			

These part numbers are also available in WP3 = high volumes (number of parts per bag: 40, 50 or 100, depending on the diameters).


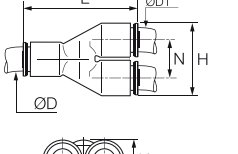

6304 Equal and Unequal Tee

Inch

		Bio-based polymer, EPDM			ØD	ØD1		G	H	L/2	kg
		1/4	1/4	6304 56 00WP2	11	24	18	0.002			
		3/8	3/8	6304 60 00WP2	16	34	26	0.009			
			1/4	6304 60 56WP2	16	34	26	0.011			
		1/2	1/2	6304 62 00WP2	22	47	36	0.027			
			3/8	6304 62 60WP2	22	47	36	0.009			

These part numbers are also available in WP3 = high volumes (number of parts per bag: 40, 50 or 100, depending on the diameters).
5/32" (4 mm) and 5/16" (8 mm) also available.


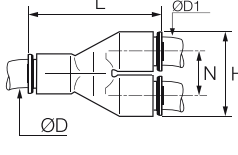

6340 Equal Single Y Piece

		Bio-based polymer, EPDM			ØD	ØD1		H	K	L	N	kg
		4	4	6340 04 00WP2	17.5	8.5	30	9	0.004			
		6	6	6340 06 00WP2	21.5	10.5	36.5	11	0.008			
		8	8	6340 08 00WP2	28	13.5	44.5	14.5	0.007			
		10	10	6340 10 00WP2	33	16	53	17	0.010			
		12	12	6340 12 00WP2	39	19	60.5	20	0.025			

These part numbers are also available in WP3 = high volumes (number of parts per bag: 40, 50 or 100, depending on the diameters).

6340 Equal Single Y Piece


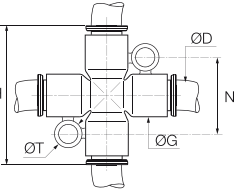

Inch

		Bio-based polymer, EPDM			ØD	ØD1		H	K	L	N	kg
		1/4	1/4	6340 56 00WP2	22	11	36	11.5	0.010			
		3/8	3/8	6340 60 00WP2	33	16	53	17	0.011			
		1/2	1/2	6340 62 00WP2	45	22	67	23	0.028			

These part numbers are also available in WP3 = high volumes (number of parts per bag: 40, 50 or 100, depending on the diameters).
5/32" (4 mm) and 5/16" (8 mm) also available.


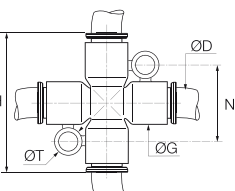

Tube-to-Tube and Bulkhead Connectors

6307 Equal Cross


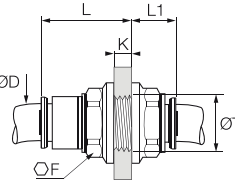

	Bio-based polymer, EPDM 	ØD 	G H N ØT kg
		6 6307 06 00WP2	11 36 20 4.2 0.005
		8 6307 08 00WP2	13.5 45 22.5 4.2 0.020

These part numbers are also available in WP3 = high volumes (number of parts per bag: 40, 50 or 100, depending on the diameters).

6307 Equal Cross


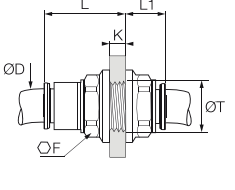

	Bio-based polymer, EPDM 	ØD 	G H N ØT kg
		1/4 6307 56 00WP2	11 36 20 4.2 0.010
		These part numbers are also available in WP3 = high volumes (number of parts per bag: 40, 50 or 100, depending on the diameters). 5/32" (4 mm) and 5/16" (8 mm) also available.	

6316 Equal Bulkhead Union

	Bio-based polymer, EPDM 	ØD 	F K max L L1 ØT min kg
		4 6316 04 00WP2	13 5.5 15.5 10.5 10.5 0.018
		6 6316 06 00WP2	15 8.5 20 10 12.5 0.004
		8 6316 08 00WP2	18 14.5 27 10.5 15.5 0.007
		10 6316 10 00WP2	22 14.5 30 13 18.5 0.012
		12 6316 12 00WP2	26 18.5 35 15.5 22.5 0.020


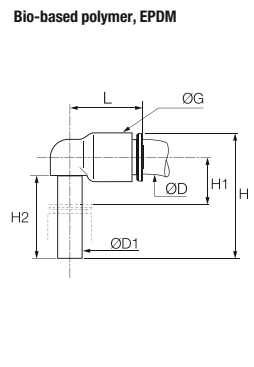


These part numbers are also available in WP3 = high volumes (number of parts per bag: 40, 50 or 100, depending on the diameters).

6316 Equal Bulkhead Union

	Bio-based polymer, EPDM 	ØD 	F K max L L1 ØT min kg
		1/4 6316 56 00WP2	15 8.5 20 10 12.5 0.004
		3/8 6316 60 00WP2	22 14.5 29.5 12.5 18.5 0.012
		1/2 6316 62 00WP2	29 20.5 40.5 17 25.5 0.030
		These part numbers are also available in WP3 = high volumes (number of parts per bag: 40, 50 or 100, depending on the diameters). 5/32" (4 mm) and 5/16" (8 mm) also available.	

Plug-In Fittings and Accessories


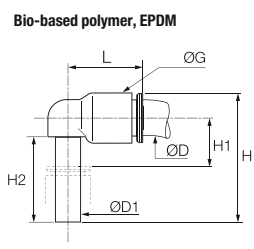


6382 Equal and Unequal Plug-In Elbow

		Bio-based polymer, EPDM			G	H	H1	H2	L	kg									
		ØD	ØD1																
																			
											4	4	6382 04 00WP2	8.5	23	6	15.5	15	0.003
												6	6382 04 06WP2	10.5	26.5	7	17	16.5	0.002
												6	6382 06 00WP2	10.5	26.5	7	17	17	0.003
												6	6382 06 04WP2	10.5	25	7	15.5	17	0.001
												8	6382 06 08WP2	13.5	33.5	8	21.5	22.5	0.004
												8	6382 08 00WP2	13.5	33.5	8	21.5	22.5	0.004
												10	6382 08 10WP2	16	39	9.5	24.5	26	0.007
												10	6382 10 00WP2	16	39	9.5	24.5	26.5	0.004
												12	6382 10 12WP2	19	44.5	10	27	30	0.011
												12	6382 12 00WP2	19	44.5	10	27	31	0.012

These part numbers are also available in WP3 = high volumes (number of parts per bag: 40, 50 or 100, depending on the diameters).


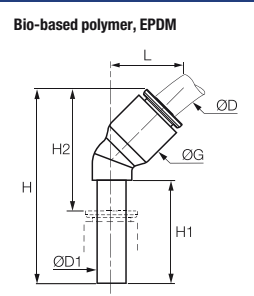


6382 Equal and Unequal Plug-In Elbow

Inch

		Bio-based polymer, EPDM			G	H	H1	H2	L	kg									
		ØD	ØD1																
																			
											5/16	3/8	6382 08 60WP2	16	39	10	24.5	26	0.009
												1/4	6382 56 00WP2	11	30.5	11	18	18	0.002
												3/8	6382 56 60WP2	16	39	9	24.5	25.5	0.006
												3/8	6382 60 00WP2	16	39	9	24.5	26.5	0.005
												1/2	6382 62 00WP2	22	49	13	28.5	36	0.011


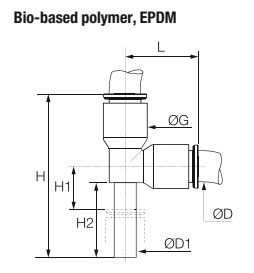


These part numbers are also available in WP3 = high volumes (number of parts per bag: 40, 50 or 100, depending on the diameters).
Equal plug-in elbow: 5/32" (4 mm) and 5/16" (8 mm) also available.

6380 Plug-In 45° Equal Elbow

		Bio-based polymer, EPDM			G	H	H1	H2	L	kg									
		ØD	ØD1																
																			
											4	4	6380 04 00WP2	8.5	33.5	19	21	13	0.001
												6	6380 06 00WP2	11	39	21	25	14.5	0.002
												8	6380 08 00WP2	13.5	44	21.5	25.5	19.5	0.006
												10	6380 10 00WP2	16	53	27	32.5	23	0.004
	12	6380 12 00WP2	19	58	27	34	26	0.012											


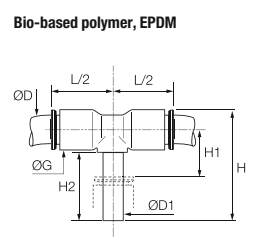


These part numbers are also available in WP3 = high volumes (number of parts per bag: 40, 50 or 100, depending on the diameters).

6383 Plug-In Equal Run Tee

		Bio-based polymer, EPDM			G	H	H1	H2	L	kg									
		ØD	ØD1																
																			
											4	4	6383 04 00WP2	8.5	33	6	15.5	15	0.002
												6	6383 06 00WP2	10.5	38.5	7	17	18	0.002
												8	6383 08 00WP2	13.5	49	8	21.5	23	0.005
												10	6383 10 00WP2	16	57	10.5	25.5	26.5	0.012
	12	6383 12 00WP2	19	65	36.5	27	31	0.016											

These part numbers are also available in WP3 = high volumes (number of parts per bag: 40, 50 or 100, depending on the diameters).

6388 Plug-In Equal Branch Tee


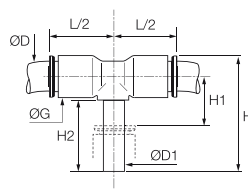

		Bio-based polymer, EPDM			G	H	H1	H2	L/2	kg									
		ØD	ØD1																
																			
											4	4	6388 04 00WP2	8.5	25	6	15.5	15	0.005
												6	6388 06 00WP2	10.5	28.5	7	17	16	0.006
												8	6388 08 00WP2	13.5	33.5	8	21.5	23	0.005
												10	6388 10 00WP2	16	41	9.5	24.5	26.5	0.007
	12	6388 12 00WP2	19	46.5	10	27	31	0.016											

These part numbers are also available in WP3 = high volumes (number of parts per bag: 40, 50 or 100, depending on the diameters).

Plug-In Fittings and Accessories


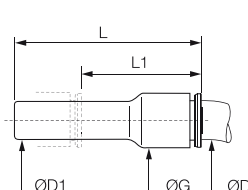

6388 Plug-In Equal Branch Tee

Inch

	Bio-based polymer, EPDM 	ØD ØD1 	G H H1 H2 L/2 kg
		1/4 1/4 6388 56 00WP2	11 30.5 11 20 18 0.002
		3/8 3/8 6388 60 00WP2	16 42 12 25 25 0.008
		1/2 1/2 6388 62 00WP2	22 51 13 29 32 0.020

These part numbers are also available in WP3 = high volumes (number of parts per bag: 40, 50 or 100, depending on the diameters).
5/32" (4 mm) and 5/16" (8 mm) also available.


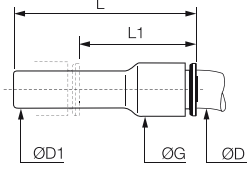

6366 Plug-In Reducer

	Bio-based polymer, EPDM 	ØD ØD1 	G L L1 kg
		4 6 6366 04 06WP2	8.5 38 23.5 0.004
		4 8 6366 04 08WP2	8.5 38 19 0.004
		6 8 6366 06 08WP2	10.5 38 20 0.004
		6 10 6366 06 10WP2	10.5 39 17.5 0.002
		8 10 6366 08 10WP2	13.5 48.5 28.5 0.009
		8 12 6366 08 12WP2	13.5 48.5 24.5 0.004
		10 12 6366 10 12WP2	16 52 33.5 0.005
		10 14 6366 10 14WP2	16 53 33.5 0.005
		12 14 6366 12 14WP2	19 55.5 33.5 0.023

These part numbers are also available in WP3 = high volumes (number of parts per bag: 40, 50 or 100, depending on the diameters).

6366 Plug-In Reducer


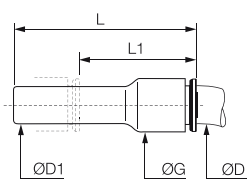

Inch

	Bio-based polymer, EPDM 	ØD ØD1 	G L L1 kg
		1/4 5/16 6366 56 08WP2	11 41 22.5 0.015
		1/4 3/8 6366 56 60WP2	11 41 20.5 0.002
		5/16 3/8 6366 08 60WP2	13.5 48.5 29 0.003
		5/16 1/2 6366 08 62WP2	16 48.5 22 0.007
		3/8 1/2 6366 60 62WP2	16 51 30 0.011

These part numbers are also available in WP3 = high volumes (number of parts per bag: 40, 50 or 100, depending on the diameters).


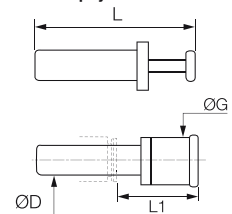

6368 Plug-In Increaser

Inch

	Bio-based polymer, EPDM 	ØD ØD1 	G L L1 kg
		3/8 5/16 6368 60 08WP2	16 44 25.5 0.004

These part numbers are also available in WP3 = high volumes (number of parts per bag: 40, 50 or 100, depending on the diameters).

6326 Blanking Plug


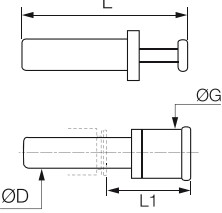

	Bio-based polymer 	ØD 	G L L1 kg
		4 6326 04 00WP2	6 30 15.5 0.001
		6 6326 06 00WP2	8 33 16.5 0.001
		8 6326 08 00WP2	10 35 17.5 0.002
		10 6326 10 00WP2	12 42 21 0.003
		12 6326 12 00WP2	14 45 22 0.004

These part numbers are also available in WP3 = high volumes (number of parts per bag: 40, 50 or 100, depending on the diameters).

Plug-In Fittings and Accessories


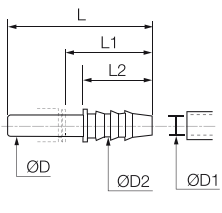

6326 Blanking Plug

Inch

	Bio-based polymer 	ØD		G	L	L1	kg
		1/4	6326 56 00WP2	8	36.5	22	0.001
		3/8	6326 60 00WP2	11.6	42.5	22	0.002
		1/2	6326 62 00WP2	14.7	48.5	21.5	0.004

These part numbers are also available in WP3 = high volumes (number of parts per bag: 40, 50 or 100, depending on the diameters).
5/32" (4 mm) and 5/16" (8 mm) also available


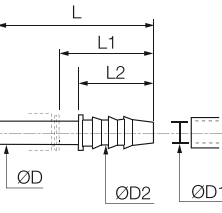

6322 Plug-In Barb Connector Inch

	Bio-based polymer 	ØD	ØD1	ØD2		L	L1	L2	kg
		6	4	7	6322 06 04WP2	39	25	17	0.004
		8	6	8.5	6322 08 06WP2	43	25	17	0.005
		10	7	8	6322 10 07WP2	50	29.5	22	0.006
		12	12.5	15.5	6322 12 62WP2	56	32	27.5	0.004

These part numbers are also available in WP3 = high volumes (number of parts per bag: 40, 50 or 100, depending on the diameters).


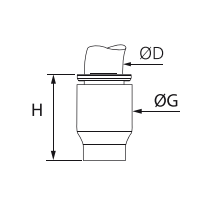

6322 Plug-In Barb Connector Inch

Inch

	Bio-based polymer 	ØD	ØD1	ØD2		L	L1	L2	kg
		1/4	0.28	0.32	6322 56 56WP2	39	24.5	17	0.001
			0.33	0.38	6322 60 08WP2	50	29.5	22	0.001
		3/8	0.28	0.32	6322 60 56WP2	45	24.5	17	0.008
			0.40	0.45	6322 60 60WP2	50	29	22	0.002
		1/2	0.40	0.45	6322 62 60WP2	58	37.5	30	0.005

These part numbers are also available in WP3 = high volumes (number of parts per bag: 40, 50 or 100, depending on the diameters).


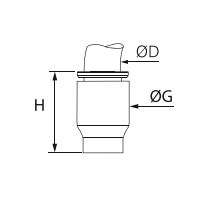

6351 End Cap

	Bio-based polymer, EPDM 	ØD		G	H	kg
		4	6351 04 00WP2	8.5	15	0.001
		6	6351 06 00WP2	10.5	17	0.002
		8	6351 08 00WP2	13.5	21.5	0.003
		10	6351 10 00WP2	16	22	0.003
		12	6351 12 00WP2	19	27.5	0.006

These part numbers are also available in WP3 = high volumes (number of parts per bag: 40, 50 or 100, depending on the diameters).

6351 End Cap







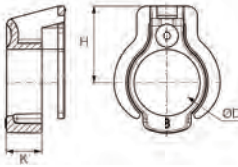
Inch

	Bio-based polymer, EPDM 	ØD		G	H	kg
		1/4	6351 56 00WP2	11	16	0.001
		3/8	6351 60 00WP2	16	22.5	0.003

These part numbers are also available in WP3 = high volumes (number of parts per bag: 40, 50 or 100, depending on the diameters).
5/32" (4 mm) and 5/16" (8 mm) also available.







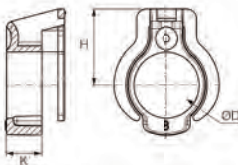
Accessories

3130 Tamper-Proof Safety Clip







Technical Polymer	ØD							H	K	kg
	4	3130 04 01	3130 04 02	3130 04 03	3130 04 04	3130 04 05	3130 04 10	6.60	3.00	0.001
	6	3130 06 01	3130 06 02	3130 06 03	3130 06 04	3130 06 05	3130 06 10	7.80	3.10	0.001
	8	3130 08 01	3130 08 02	3130 08 03	3130 08 04	3130 08 05	3130 08 10	9.50	4.30	0.001
	10	3130 10 01	3130 10 02	3130 10 03	3130 10 04	3130 10 05	3130 10 10	10.80	4.20	0.002
	12	3130 12 01	3130 12 02	3130 12 03	3130 12 04	3130 12 05	3130 12 10	12.50	5.10	0.003
	14	3130 14 01	3130 14 02	3130 14 03	3130 14 04	3130 14 05	3130 14 10	12.50	5.10	0.004

3130 Tamper-Proof Safety Clip

Inch







Technical Polymer	ØD							H	K	kg
	1/4	3130 56 01	3130 56 02	3130 56 03	3130 56 04	3130 56 05	3130 56 10	7.80	3.10	0.001
	3/8	3130 60 01	3130 60 02	3130 60 03	3130 60 04	3130 60 05	3130 60 10	10.80	4.20	0.002
	1/2	3130 62 01	3130 62 02	3130 62 03	3130 62 04	3130 62 05	3130 62 10	12.50	5.10	0.003
	5/32" (4 mm) and 5/16" (8 mm) also available.									

3110 Coloured Release Button Covers



Technical Polymer	ØD						kg
	4	3110 04 00	3110 04 02	3110 04 03	3110 04 04	3110 04 05	0.001
	6	3110 06 00	3110 06 02	3110 06 03	3110 06 04	3110 06 05	0.001
	8	3110 08 00	3110 08 02	3110 08 03	3110 08 04	3110 08 05	0.001
	10	3110 10 00	3110 10 02	3110 10 03	3110 10 04	3110 10 05	0.001
	12	3110 12 00	3110 12 02	3110 12 03	3110 12 04	3110 12 05	0.001
	14	3110 14 00	3110 14 02	3110 14 03	3110 14 04	3110 14 05	0.002

3110 Coloured Release Button Covers

Inch

Technical Polymer	ØD						kg
	1/4	3110 56 00	3110 56 02	3110 56 03	3110 56 04	3110 56 05	0.001
	3/8	3110 60 00	3110 60 02	3110 60 03	3110 60 04	3110 60 05	0.001
	1/2	3110 62 00	3110 62 02	3110 62 03	3110 62 04	3110 62 05	0.001
	5/32" (4 mm) and 5/16" (8 mm) also available						

0605 Fluoropolymer Tape

	FKM		kg
		0605 12 12	0.012
	Can be used for temperatures from - 250°C to +260°C. Chemically inert and resistant to gases, acids, solvents, hydrocarbons, oils, alkalines, steam, etc. Non-toxic, waterproof, self-lubricating. In accordance with CFR21. Can be used on all materials. Used to facilitate the preparation of leak-free threaded joints. Supplied on a reel: length = 12 m; width = 12.7 mm; thickness = 0.08 mm.		

LIQUIfit+ Push-In Fittings

For the transfer of sensitive fluids, the LIQUIfit+ range **reduces the growth of bacteria** in your circuits **for 100% cleanliness after cleaning**, and can be **directly** connected to stainless steel tubing, without grooving.

Product Advantages

Zero Retention for 100% Cleanliness

- Up to 10 times less microbial growth within the fitting
- Elimination of 99.9% of bacteria during cleaning operations
- No degradation of the beverage taste
- Preservation of the integrity of sensitive or industrial fluids
- Extension of the fitting's life due to the absence of bacteria after cleaning

Quality & Reliability

- 100% leak-tested in production
- Date coding to guarantee quality and traceability
- Quality approved for contact with food
- Excellent chemical resistance (chlorine, cleaning agents, UV...)
- Excellent long-term mechanical resistance
- Safety clip to avoid any untimely disconnection

Innovative Technology

- Patented push-in connection, unique on stainless steel tubing (without preparation) and on polymer tubing
- Extremely compact
- 100% bio-based material
- Patented sealing technology (FR29461418)
- No tube movement after connection



Applications

- Food Process
- Medical
- Beverage Dispensers
- Pharmaceutical
- Chemical
- Brewing

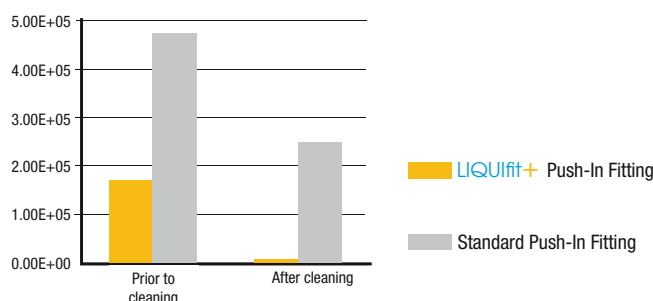
Technical Characteristics

Compatible Fluids	Beer, water, beverages, industrial fluids
Working Pressure	Vacuum to 16 bar
Working Temperature	-10°C to +95°C (see LIQUIfit® chart p. 1-47)

Reliable performance is dependent upon the type of fluid conveyed, component materials and tubing being used. The use is guaranteed with a vacuum of 755 mm Hg (99% vacuum).

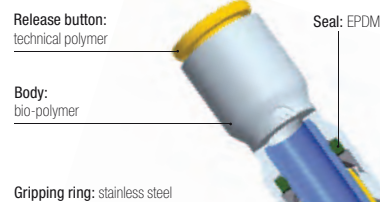
Cleaning Efficiency

Comparison of the contamination by micro-organisms before and after cleaning operations (cfu/surface)*



* Tests carried out by an independent laboratory

Component Materials



Silicone-free

Regulations


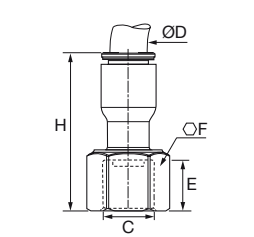

- DI: 2002/95/EC (RoHS), 2011/65/EC
- RG: 1935/2004/EC
- FDA: 21 CFR NSF51
- NSF/ANSI 61 - C HOT



LIQUIfit+ Push-In Fittings

6333 Stud Fitting, Female BSPP Thread


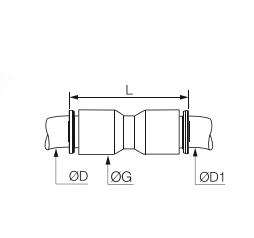

Inch

		ØD	C		E	F	H	kg
		3/8	G1/2	6333 60 21WP3	14	11	30	0.010
		3/8	G5/8	6333 60 23WP3	14	13	36	0.016

WP3 suffix = high volume (number of parts per bag: 40, 50 or 100 depending on the diameters).

6336 Equal and Unequal Tube-to-Tube Connector


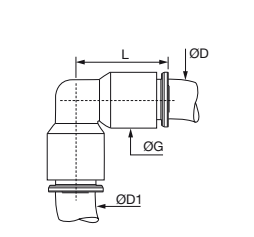

Inch

		ØD	ØD1		ØG	L	kg
		5/16		6336 08 00WP3	13.5	37	0.004
		5/16	3/8	6336 08 60WP3	16	42	0.008
			1/2	6336 08 62WP3	22	55	0.016
		3/8	3/8	6336 60 00WP3	16	42	0.006
			1/2	6336 60 62WP3	22	56	0.020
		1/2	1/2	6336 62 00WP3	22	57	0.016

WP3 suffix = high volume (number of parts per bag: 40, 50 or 100 depending on the diameters).

6332 Equal and Unequal Elbow


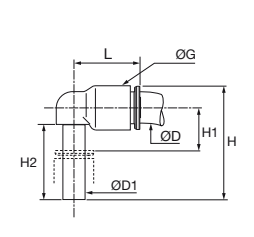

Inch

		ØD	ØD1		ØG	L	kg
		5/16	5/16	6332 08 00WP3	13.5	29	0.004
		5/16	3/8	6332 08 60WP3	16	34	0.009
		3/8	3/8	6332 60 00WP3	16	34	0.006
		3/8	1/2	6332 60 62WP3	22	46.5	0.011
		1/2	1/2	6332 62 00WP3	22	46.5	0.017

WP3 suffix = high volume (number of parts per bag: 40, 50 or 100 depending on the diameters).

6331 Equal Plug-In Elbow

Inch

		ØD	ØD1		ØG	H	H1	H2	L	kg
		5/16	5/16	6331 08 00WP3	13.5	33.5	8	21.5	22.5	0.004
		3/8	3/8	6331 60 00WP3	16	39	9	24.5	26.5	0.005

WP3 suffix = high volume (number of parts per bag: 40, 50 or 100 depending on the diameters).

Use with Stainless Steel Tubing

- These fittings are approved for use with 304 and 316L stainless steel tubing, 160 Hv, with tolerances on the external diameter +0.05/-0.10 mm.
- Carefully deburr the stainless steel tube end.
- For easy disconnection, press firmly on the release button.
- After 5 connections/disconnections, we recommend that you change the fitting.



LF 3600 Push-In Fittings Range

Stud Fittings

Straights



Elbows



Tees



Banjo



Tube-to-Tube Fittings

Straight



Elbow



Tee



Bulkhead Connector Fittings

Straights



Elbow



Plug-In Accessories



Accessories



LF 3600 Push-In Fittings

In order to meet your **technical and environment requirements**, Parker Legris designed this range of metal fittings, offering **robustness, reliability** and **resistance to industrial fluids** for the most demanding environments.

Product Advantages

- High Performance**
 - Resistant up to +150°C at 30 bar
 - Excellent mechanical performance
 - Long threads to resist shock and vibration
 - Excellent abrasion and corrosion resistance due to high phosphorus chemical nickel plating
 - Full flow, minimal pressure drop
- Versatility**
 - Materials conform to FDA standards
 - Spring collet gripping system suitable for both metal (grooved) and polymer tubing
 - Excellent resistance to high pressure and vacuum
 - Excellent chemical compatibility
 - More than 250 part numbers
 - One fitting for numerous applications: stock optimisation
 - Manual connection and disconnection
 - Compact and ergonomic
- Reliability**
 - High performance brass for increased lifespan
 - 100% leak-tested in production
 - Date coding to guarantee quality and traceability



Food Process
Coffee Machines
In-Plant Automotive
Medical Equipment
Printing
Misting
Welding Robots

Applications

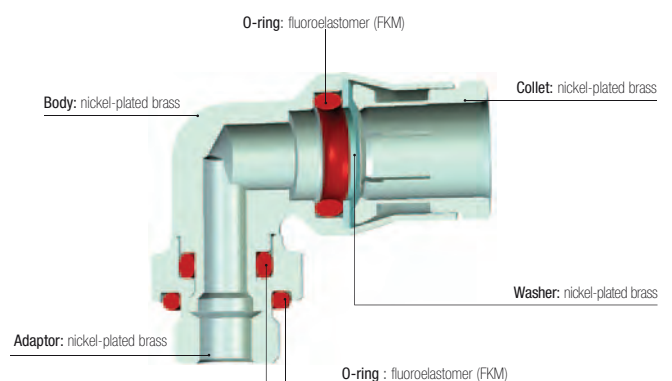
Technical Characteristics

Suitable Fluids	Compressed air, grease, lubricant, water...
Working Pressure	Vacuum to 30 bar (20 bar: 3699, 3609)
Working Temperature	-20°C to +150°C

Maximum Tightening Torque (daN.m)	Thread							
	M5 x0.8	M6 x1	M8 x1	M10 x1	G1/8	G1/4	G3/8	G1/2
	0.16	0.18	0.6	0.8	0.8	1.2	3	3.5

Reliable performance is dependent upon the type of fluid conveyed, component materials and tubing being used.
Use is guaranteed with a vacuum of 755 mm Hg (99% vacuum).

Component Materials



Silicone-free


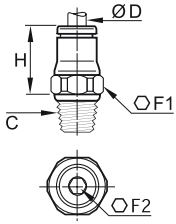


Regulations

Industrial
 ISO 14743: pneumatic transmissions, push-in fittings for thermoplastic tubing
 DI: 97/23/EC (PED)
 DI: 2002/95/EC (RoHS), 2011/65/EC
 RG: 1907/2006 (REACH)
 DI: 94/9/EC (ATEX)
 UL94 V-0: please consult us


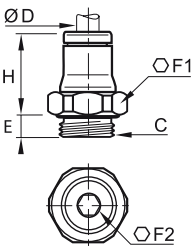


Food
 RG: 21CFR (FDA)
 RG: 1935/2004/EC (minimum flow 0.02 l/h)
 USDA NSF H1: grease
 ASTM B733-04: autocatalytic (electroless) nickel-phosphorus coatings

Stud Fittings


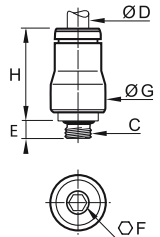


3675 Stud Fitting, Male BSPT Thread

  	FDA chemical nickel-plated brass, FKM		ØD	C		F1	F2	H	kg
	4	R1/8	3675 04 10	10	3	15	0.009		
		R1/4	3675 04 13	14	3	15	0.017		
	6	R1/8	3675 06 10	13	4	17	0.011		
		R1/4	3675 06 13	14	4	17	0.018		
	8	R1/8	3675 08 10	15	5	19	0.015		
		R1/4	3675 08 13	16	6	18	0.019		
		R3/8	3675 08 17	17	6	18.5	0.027		
		R1/4	3675 10 13	18	7	23	0.026		
	10	R3/8	3675 10 17	18	8	22.5	0.031		
		R1/2	3675 10 21	22	8	22.5	0.056		
		R1/4	3675 12 13	20	7	25.5	0.033		
	12	R3/8	3675 12 17	20	9	24	0.035		
		R1/2	3675 12 21	22	10	23	0.051		
	14	R3/8	3675 14 17	22	9	27	0.042		
		R1/2	3675 14 21	24	11	26	0.057		

3601 Stud Fitting, Male BSPP and Metric Thread

  	FDA chemical nickel-plated brass, FKM		ØD	C		E	F1	F2	H	kg
	4	M5x0.8	3601 04 19	3.5	10	2.5	15.5	0.006		
		M6x1	3601 04 52	4.5	10	3	16	0.006		
		M8x1	3601 04 56	5	11	3	14.5	0.007		
		G1/8	3601 04 10	5.5	13	3	14.5	0.009		
		G1/4	3601 04 13	6.5	16	3	14.5	0.015		
	6	M5x0.8	3601 06 19	3.5	13	2.5	19	0.010		
		M10x1	3601 06 60	5.5	13	4	17.5	0.011		
		G1/8	3601 06 10	5.5	13	4	17.5	0.011		
		G1/4	3601 06 13	6.5	16	4	17	0.015		
	8	G1/8	3601 08 10	5.5	16	5	20	0.014		
		G1/4	3601 08 13	6.5	16	6	18	0.016		
		G3/8	3601 08 17	7.5	20	6	19	0.028		
		G1/4	3601 10 13	6.5	18	7	25	0.025		
	10	G3/8	3601 10 17	7.5	20	8	22.5	0.028		
		G1/2	3601 10 21	9	24	8	22.5	0.043		
		G1/4	3601 12 13	6.5	20	7	26.5	0.030		
	12	G3/8	3601 12 17	7.5	20	9	26	0.034		
		G1/2	3601 12 21	9	24	10	23.5	0.042		
	14	G3/8	3601 14 17	7.5	22	9	28	0.038		
	G1/2	3601 14 21	9	24	11	26.5	0.045			

3681 Stud Fitting with Internal Hexagon, Male Metric Thread


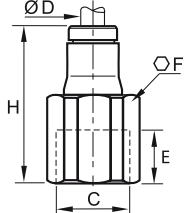


  	FDA chemical nickel-plated brass, FKM		ØD	C		E	F	G	H	kg
	4	M5x0.8	3681 04 19	3.5	2.5	10	16	0.005		

Related Products


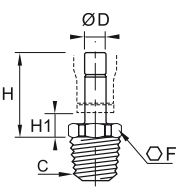


- Polyurethane Tubing
- Polyamide Tubing
- Polyethylene Tubing
- Fluoropolymer Tubing
- Anti-Spark Tubing
- Fireproof PA Tubing
- Brass Flow Control Regulators

Stud Fittings


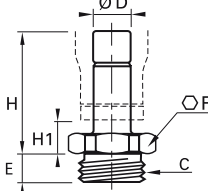


3614 Stud Fitting, Female BSPP and Metric Thread

	FDA chemical nickel-plated brass, FKM				E	F	H	kg
	ØD	C						
		M5x0.8	3614 04 19		5	10	22	0.009
	4	G1/8	3614 04 10		7.5	14	25	0.016
		G1/4	3614 04 13		11	17	29	0.026
	6	G1/8	3614 06 10		7.5	14	27.5	0.019
		G1/4	3614 06 13		11	17	31.5	0.028
	8	G1/8	3614 08 10		9.5	15	28.5	0.022
		G1/4	3614 08 13		13.5	17	32.5	0.028
	10	G3/8	3614 10 17		14	22	38	0.052
		G3/8	3614 12 17		14	22	39	0.055
	12	G1/2	3614 12 21		18.5	24	43.5	0.062


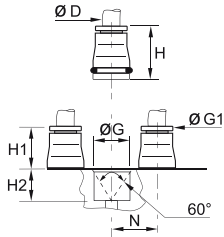


3621 Stud Standpipe, Male BSPT Thread

	FDA chemical nickel-plated brass				F	H	H1	kg
	ØD	C						
	4	R1/8	3621 04 10		10	21	7	0.006
		R1/4	3621 04 13		14	21	7	0.014
	6	R1/8	3621 06 10		10	23.5	6.5	0.008
		R1/4	3621 06 13		14	23.5	6.5	0.016
	8	R1/8	3621 08 10		10	24	6.5	0.009
		R1/4	3621 08 13		14	24	6.5	0.017
	10	R1/4	3621 10 13		14	22	6.5	0.018
		R3/8	3621 10 17		17	30	7.5	0.022
	12	R3/8	3621 12 17		17	31	7.5	0.023
		R1/2	3621 12 21		22	31	7.5	0.041
	14	R1/2	3621 14 21		22	33	8	0.042

3631 Stud Standpipe, Male BSPP and Metric Thread

	FDA chemical nickel-plated brass, FKM				E	F	H	H1	kg
	ØD	C							
		M5x0.8	3631 04 19		3.5	13	21.5	7	0.003
	4	G1/8	3631 04 10		5.5	13	20	7	0.007
		G1/4	3631 04 13		6.5	8	20	7.5	0.011
	6	G1/8	3631 06 10		5.5	13	22.5	6.5	0.009
		G1/4	3631 06 13		6.5	16	22.5	6.5	0.012
	8	G1/8	3631 08 10		5.5	13	22.5	6.5	0.010
		G1/4	3631 08 13		6.5	16	23	6.5	0.013
	10	G3/8	3631 08 17		7.5	20	23	7.5	0.018
		G1/4	3631 10 13		6.5	16	28	6.5	0.015
	12	G3/8	3631 10 17		7.5	20	28	7.5	0.022
		G1/2	3631 10 21		9	24	28	7.5	0.028
	14	G3/8	3631 12 17		7.5	20	29	7.5	0.023
		G1/2	3631 12 21		9	24	29	7.5	0.033
		G1/2	3631 14 21		9	24	31	8	0.033


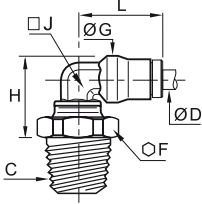

3600 Cartridge

	FDA chemical nickel-plated brass, FKM				G	G1	H	H1	H2	N	kg
	ØD										
	4	3600 04 00			9.8	8	17	8.5	8.5	11	0.006
	6	3600 06 00			12.1	10	19	10.5	8.5	13.5	0.009
	8	3600 08 00			14.8	13	21	12.5	8.5	16	0.012
	10	3600 10 00			17.5	15	24.5	14	10.5	20	0.019
	12	3600 12 00			20	17	25	14.5	10.5	22.5	0.023
	14	3600 14 00			22	20	28.5	16.5	12	25	0.031

Cavity dimensions available in Chapter 2


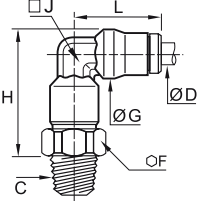

Stud Fittings

3609 Stud Elbow, Male BSPT Thread

		FDA chemical nickel-plated brass, FKM			ØD	C	F	G	H	J	L	kg
		4	R1/8 3609 04 10	13	10	15	7	18	0.014			
		4	R1/4 3609 04 13	14	10	17	7	18	0.020			
		6	R1/8 3609 06 10	13	12	17.5	8	21.5	0.018			
		6	R1/4 3609 06 13	14	12	19	8	21.5	0.025			
		8	R1/8 3609 08 10	13	15	19.5	10	23.5	0.023			
		8	R1/4 3609 08 13	14	15	21	10	23.5	0.029			
		8	R3/8 3609 08 17	17	15	21	10	23.5	0.035			
		10	R1/4 3609 10 13	15	17.5	23.5	12	29	0.037			
		10	R3/8 3609 10 17	17	17.5	25.5	12	29	0.043			
		12	R1/4 3609 12 13	15	19.5	26	15	31	0.049			
		12	R3/8 3609 12 17	17	19.5	28.5	15	31	0.055			
		12	R1/2 3609 12 21	21	19.5	28.5	15	31	0.072			
		14	R3/8 3609 14 17	19	21.5	29	16	34	0.063			
		14	R1/2 3609 14 21	22	21.5	30	16	34	0.072			


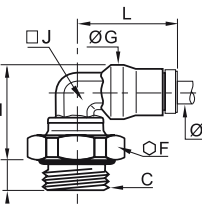

The body swivels for positioning purposes.

3629 Extended Stud Elbow, Male BSPT Thread

		FDA chemical nickel-plated brass, FKM			ØD	C	F	G	H	J	L	kg
		4	R1/8 3629 04 10	10	10	24.5	7	18	0.025			
		4	R1/8 3629 06 10	13	12	29.5	8	21.5	0.024			
		6	R1/4 3629 06 13	14	12	30.5	8	21.5	0.031			
		8	R1/8 3629 08 10	14	15	32.5	10	23.5	0.031			
		8	R1/4 3629 08 13	14	15	34	10	23.5	0.037			
		10	R1/4 3629 10 13	18	17.5	39	12	29	0.054			

The body swivels for positioning purposes.


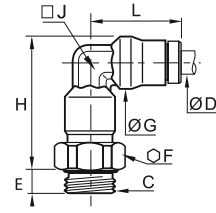


3699 Compact Elbow, Male BSPP and Metric Thread

		FDA chemical nickel-plated brass, FKM			ØD	C	E	F	G	H	J	L	kg
		4	M5x0.8 3699 04 19	3.5	10	10	18	7	18	0.011			
		4	M6x1 3699 04 52	4.5	10	10	18	7	18	0.011			
		4	M8x1 3699 04 56	5	11	10	18	7	18	0.013			
		4	G1/8 3699 04 10	5.5	13	10	17	7	18	0.014			
		4	G1/4 3699 04 13	6.5	16	10	17.5	7	18	0.019			
		6	M10x1 3699 06 60	5.5	13	12	19	8	21.5	0.017			
		6	G1/8 3699 06 10	5.5	13	12	19	8	21.5	0.018			
		6	G1/4 3699 06 13	6.5	16	12	19.5	8	21.5	0.022			
		6	G1/8 3699 08 10	5.5	13	15	20.5	10	23.5	0.021			
		8	G1/4 3699 08 13	6.5	16	15	21.5	10	23.5	0.027			
		8	G3/8 3699 08 17	7.5	20	15	21.5	10	23.5	0.033			
		10	G1/4 3699 10 13	6.5	16	17.5	27	12	29	0.037			
		10	G3/8 3699 10 17	7.5	20	17.5	25.5	12	29	0.043			
		12	G1/4 3699 12 13	6.5	16	19.5	29.5	15	31	0.050			
		12	G3/8 3699 12 17	7.5	20	19.5	28.5	15	31	0.057			
		12	G1/2 3699 12 21	9	24	19.5	28.5	15	31	0.065			
		14	G3/8 3699 14 17	7.5	20	21.5	29	16	34	0.059			
		14	G1/2 3699 14 21	9	24	21.5	29.5	16	34	0.062			

The body swivels for positioning purposes.


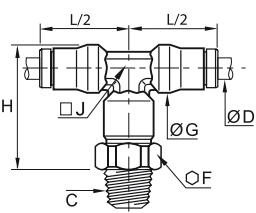


Stud Fittings

3669 Extended Stud Elbow, Male BSPP and Metric Thread

	FDA chemical nickel-plated brass, FKM			ØD	C		E	F	G	H	J	L	kg
				4	M5x0.8	3669 04 19	3.5	10	10	27.5	7	18	0.014
					G1/8	3669 04 10	5.5	13	10	25.5	7	18	0.017
				6	G1/8	3669 06 10	5.5	13	12	31	8	21.5	0.024
					G1/4	3669 06 13	6.5	16	12	30.5	8	21.5	0.028
				8	G1/8	3669 08 10	5.5	14	15	33.5	10	23.5	0.031
					G1/4	3669 08 13	5.5	16	15	34	10	23.5	0.035
				10	G1/4	3669 10 13	6.5	18	17.5	42	12	29	0.052
					G3/8	3669 10 17	7.5	20	17.5	41	12	29	0.056
				12	G1/4	3669 12 13	6.5	20	19.5	47	15	31	0.070
					G3/8	3669 12 17	7.5	20	19.5	46	15	31	0.072
				14	G1/2	3669 14 21	9	24	21.5	49	16	34	0.094


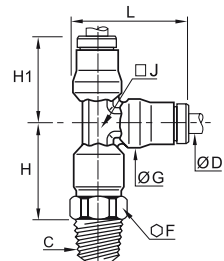


The body swivels for positioning purposes.

3608 Stud Branch Tee, Male BSPT Thread

	FDA chemical nickel-plated brass, FKM			ØD	C		F	G	H	J	L/2	kg
				4	R1/8	3608 04 10	10	10	24.5	7	18	0.020
					R1/8	3608 06 10	13	12	29.5	8	21.5	0.031
				6	R1/4	3608 06 13	14	12	30.5	8	21.5	0.038
					R1/8	3608 08 10	14	15	32.5	10	23.5	0.040
				8	R1/4	3608 08 13	14	15	34	10	23.5	0.047
				10	R1/4	3608 10 13	18	17.5	39	12	29	0.067
					R3/8	3608 10 17	18	17.5	41	12	29	0.070
				12	R3/8	3608 12 17	20	19.5	46.5	15	31	0.094
				14	R1/2	3608 14 21	22	21.5	50.5	16	34	0.125


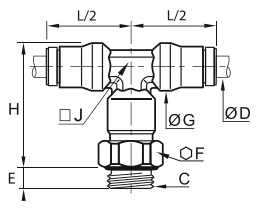


The body swivels for positioning purposes.

3603 Stud Run Tee, Male BSPT Thread

	FDA chemical nickel-plated brass, FKM			ØD	C		F	G	H	H1	J	L	kg
				4	R1/8	3603 04 10	10	10	19.5	18	7	23	0.018
					R1/8	3603 06 10	13	12	23.5	21.5	8	28	0.031
				6	R1/4	3603 06 13	14	12	24.5	21.5	8	28	0.037
					R1/8	3603 08 10	14	15	25	23.5	10	31	0.041
				8	R1/4	3603 08 13	14	15	26.5	23.5	10	31	0.044
				10	R1/4	3603 10 13	18	17.5	30.5	29	12	37.5	0.067
					R3/8	3603 10 17	18	17.5	32.5	29	12	37.5	0.069
				12	R3/8	3603 12 17	20	19.5	36.5	31	15	40.5	0.103
				14	R1/2	3603 14 21	22	21.5	40	34	16	45	0.147

The body swivels for positioning purposes.


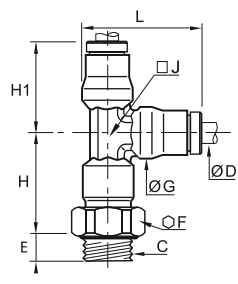

3698 Stud Branch Tee, Male BSPP and Metric Thread

	FDA chemical nickel-plated brass, FKM			ØD	C		E	F	G	H	J	L/2	kg
				4	M5x0.8	3698 04 19	3.5	10	10	27.5	7	18	0.018
					G1/8	3698 04 10	5.5	13	10	25.5	7	18	0.021
				6	G1/8	3698 06 10	5.5	13	12	31	8	21.5	0.031
					G1/4	3698 06 13	6.5	16	12	30.5	8	21.5	0.035
				8	G1/8	3698 08 10	5.5	14	15	33.5	10	23.5	0.041
					G1/4	3698 08 13	6.5	16	15	34	10	23.5	0.045
				10	G1/4	3698 10 13	6.5	18	17.5	42	12	29	0.066
					G3/8	3698 12 17	7.5	20	19.5	46	15	31	0.088
				14	G1/2	3698 14 21	9	24	21.5	49	16	34	0.111

The body swivels for positioning purposes.


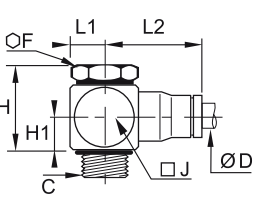

Stud Fittings

3693 Stud Run Tee, Male BSPP and Metric Thread

	FDA chemical nickel-plated brass, FKM			ØD	C		E	F	G	H	H1	J	L	kg
	4	M5x0.8		3693 04 19	3.5		10	10	22.5	18	7	23	0.019	
	G1/8	3693 04 10	5.5	13	10	20.5	18	7	23	0.021				
	6	G1/8	3693 06 10	5.5	13	12	25	21.5	8	28	0.031			
	G1/4	3693 06 13	6.5	16	12	24.5	21.5	8	28	0.035				
	8	G1/8	3693 08 10	5.5	14	15	26.5	23.5	10	31	0.041			
	G1/4	3693 08 13	6.5	16	15	26.5	23.5	10	31	0.044				
	10	G1/4	3693 10 13	6.5	18	17.5	33	29	12	37.5	0.066			
	12	G3/8	3693 12 17	7.5	20	19.5	36.5	31	15	40.5	0.090			
	14	G1/2	3693 14 21	9	24	21.5	38.5	34	16	45	0.112			

The body swivels for positioning purposes.

3618 Single Banjo, Male BSPP and Metric Thread

	FDA chemical nickel-plated brass, FKM			ØD	C		F	H	H1	J	L1	L2	kg
	4	M5x0.8		3618 04 19	8		14.5	6.5	10	6	18.5	0.011	
	G1/8	3618 04 10	14	23	9.5	17	10	20.5	0.029				
	6	M5x0.8	3618 06 19	8	15	7	10	6	22.5	0.015			
	G1/8	3618 06 10	14	23	9.5	17	10	23.5	0.031				
	G1/4	3618 06 13	17	22	9	22	13	25.5	0.049				
	8	G1/8	3618 08 10	14	23	9.5	17	10	26	0.033			
	G1/4	3618 08 13	17	22	9	22	13	27.5	0.051				
	10	G3/8	3618 10 17	22	33	14	22	13	32	0.105			


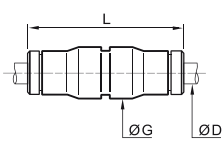

Maximum temperature: +80°C

Each model has been designed to meet specific requirements: compactness due to small overall dimensions, with inter-connectability for customised configurations.


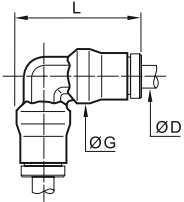



Tube-to-Tube Fittings


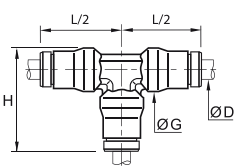

3606 Equal Tube-to-Tube Connector

 	FDA chemical nickel-plated brass, FKM		ØD		G	L	kg
	4	3606 04 00	10	30.5	0.010		
	6	3606 06 00	12	36.5	0.016		
	8	3606 08 00	15	37.5	0.021		
	10	3606 10 00	17.5	47.5	0.034		
	12	3606 12 00	19.5	50	0.042		
	14	3606 14 00	21.5	52.5	0.050		

3602 Equal Elbow


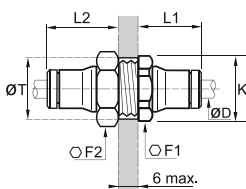

 	FDA chemical nickel-plated brass, FKM		ØD		G	L	kg
	4	3602 04 00	10	23	0.010		
	6	3602 06 00	12	28	0.016		
	8	3602 08 00	15	31	0.023		
	10	3602 10 00	17.5	37.5	0.033		
	12	3602 12 00	19.5	40.5	0.045		
	14	3602 14 00	21.5	45	0.056		

3604 Equal Tee


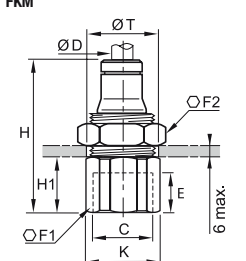

 	FDA chemical nickel-plated brass, FKM		ØD		G	H	L/2	kg
	4	3604 04 00	10	23	18	0.014		
	6	3604 06 00	12	28	21.5	0.023		
	8	3604 08 00	15	31	23.5	0.032		
	10	3604 10 00	17.5	37.5	29	0.048		
	12	3604 12 00	19.5	40.5	31	0.063		
	14	3604 14 00	21.5	45	34	0.078		

Bulkhead Connector Fittings


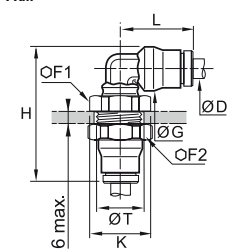

3616 Equal Bulkhead Connector

	FDA chemical nickel-plated brass, FKM 	ØD		F1	F2	K	L1	L2	ØT min	kg
		4	3616 04 00	13	14	14	14	20	12.5	0.018
		6	3616 06 00	16	17	17.5	17	22	15	0.028
		8	3616 08 00	18	19	19.5	18.5	23.5	17	0.035
		10	3616 10 00	22	27	24	21.5	26.5	21	0.063
		12	3616 12 00	24	24	26	23	27	23	0.062
		14	3616 14 00	27	27	29.5	25.5	29.5	25	0.079

3636 Bulkhead Connector, Female BSPP Thread

	FDA chemical nickel-plated brass, FKM 	ØD	C		E	F1	F2	H	H1	K	ØT min	kg
		4	G1/8	3636 04 10	8.5	14	14	30.5	11	15	13	0.020
		6	G1/8	3636 06 10	8.5	17	17	33	11	18.5	15	0.033
			G1/4	3636 06 13	11.5	17	17	37	15	18.5	15	0.033
		8	G1/8	3636 08 10	8.5	19	19	34	10.5	21	17	0.044
			G1/4	3636 08 13	11.5	19	19	38	14.5	21	17	0.044
		10	G3/8	3636 10 17	12	22	27	42.5	16	24	21	0.073
			G3/8	3636 12 17	12	24	24	43	16	26	23	0.077
		12	G1/2	3636 12 21	16	27	24	48.5	21.5	29.5	23	0.133


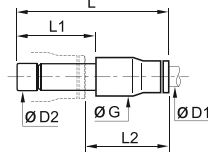

3639 Equal Bulkhead Elbow

	FDA chemical nickel-plated brass, FKM 	ØD		F1	F2	G	H	K	L	ØT min	kg
		4	3639 04 00	13	14	10	35	14	18	12.5	0.023
		6	3639 06 00	16	17	12	40.5	17.5	21.5	15	0.035
		8	3639 08 00	18	19	15	44	19.5	23.5	17	0.046
		10	3639 10 00	22	27	17.5	51	24	29	21	0.080
		12	3639 12 00	24	24	19.5	55	26	31	23	0.086
		14	3639 14 00	27	27	21.5	59	29.5	34	25	0.144


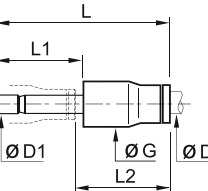

The body swivels for positioning purposes.

Plug-In Accessories


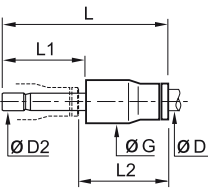

3666 Plug-In Reducer

	 <p>FDA chemical nickel-plated brass, FKM</p>	ØD1	ØD2		G	L	L1	L2	kg
		4	6	3666 04 06	10	35	19.5	18	0.008
			8	3666 04 08	10	35.5	20	18	0.009
		6	8	3666 06 08	12	38	20	20.5	0.012
			10	3666 06 10	12	43.5	25	21	0.015
		8	10	3666 08 10	15	44	25	21.5	0.016
			12	3666 08 12	15	44	26	20.5	0.018
		10	12	3666 10 12	17.5	50	26	27	0.026
		12	14	3666 12 14	19.5	53	28	28.5	0.032


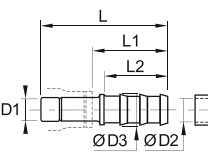

3667 Plug-In Metric/Inch Adaptor

	 <p>FDA chemical nickel-plated brass, FKM</p>	ØD1	ØD2		G	L	L1	L2	kg
		6	1/4	3667 06 56	12.5	38.5	19.5	21	0.012
		10	3/8	3667 10 60	17	49.5	25	27	0.026
		12	1/2	3667 12 62	20	51	26	27.5	0.030


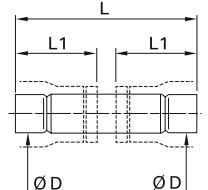

3668 Plug-In Increaser

	 <p>FDA chemical nickel-plated brass, FKM</p>	ØD1	ØD2		G	L	L1	L2	kg
		6	4	3668 06 04	12	36	17	21.5	0.010

3622 Plug-In Barb Connector


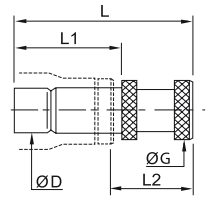

	 <p>FDA chemical nickel-plated brass</p>	ØD1	ØD2		ØD3	L	L1	L2	kg
		4	3.2	3622 04 53	5	40.5	27	22.5	0.003
			5	3622 04 05	7	40.5	27	22.5	0.005
		6	5	3622 06 05	7	43	27	22.5	0.006
			6.3	3622 08 56	8.3	42	25	22.5	0.008
		8	8	3622 08 08	10	44	27	22.5	0.010
			6.3	3622 10 56	8.3	47.5	25.5	22.5	0.011
		10	8	3622 10 08	10	47.5	25.5	22.5	0.011
			8	3622 12 08	10	48.5	25.5	22.5	0.015
		12	10	3622 12 10	10	48.5	25.5	22.5	0.014
			12.5	3622 12 62	14.5	57	34	29.5	0.019
		14	12.5	3622 14 62	16	57.5	33	29.5	0.023
			14	3622 14 14	16	59.5	35	29.5	0.023

3620 Male Stem Connector



	 <p>FDA chemical nickel-plated brass</p>	ØD		L	L1	kg
		4	3620 04 00	31	14	0.002
		6	3620 06 00	36.5	17	0.005
		8	3620 08 00	37.5	17.5	0.007
		10	3620 10 00	47.5	22.5	0.011
		12	3620 12 00	49.5	23.5	0.015
		14	3620 14 00	53	25	0.016

Plug-In Accessories


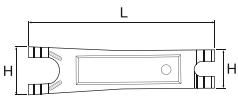

3626 Blanking Plug

	FDA chemical nickel-plated brass 		ØD	G	L	L1	L2	kg
			4 3626 04 00 6 3626 06 00 8 3626 08 00 10 3626 10 00 12 3626 12 00 14 3626 14 00	6 8 10 12 14 16	25.5 30.5 33 40 43 47	17.5 19.5 20 25 26 28	11.5 13.5 16 18 20 22.5	0.004 0.009 0.009 0.015 0.021 0.029

0605 Fluoropolymer Tape



	FKM		kg
			0605 12 12 0.012 Can be used for temperatures from - 250°C to +260°C. Chemically inert and resistant to gases, acids, solvents, hydrocarbons, oils, alkalines, steam etc. Non-toxic, waterproof, self-lubricating. In accordance with CFR21. Can be used on all materials. Used to facilitate the preparation of leak-free threaded joints. Supplied on a reel, length = 12 m; width = 12.7 mm; thickness 0.08 mm.

3000 70 00 Disconnection Tool

	Treated steel 		H	H1	L	kg
			3000 70 00	25 20 96	20 20 96	96 96 96

For disconnecting LF 3000® fittings/tubing where access is difficult, we recommend the use of this disconnection tool.

3610 Coloured Release Button Covers

	Anodised aluminium		ØD	kg
			6 3610 06 00 3610 06 04 8 3610 08 00 3610 08 04 10 3610 10 00 3610 10 04 12 3610 12 00 3610 12 04 14 3610 14 00 3610 14 04	0.004 0.007 0.011 0.013 0.016

Red and green colours are available upon request
 Coloured release buttons covers help the identification of circuits and will protect your connections against spark projections.

LF 3800/LF 3900 Push-In Fittings Range

Stud Fittings

Straights

3805
3905
BSPT
Page 1-79



3805
NPT
Page 1-79



3801
3901
BSPP/Metric
Page 1-79



3821
3921
BSPT
Page 1-80



3821
3921
NPT
Page 1-80



3831
3931
BSPP/Metric
Page 1-80



3800
3900
Page 1-81



Straights - Inch

3805
NPT
Page 1-79



3821
NPT
Page 1-80



Elbows

3809
3909
BSPT
Page 1-81



3809
NPT
Page 1-81



3899
3999
BSPP/Metric
Page 1-81



3889
3989
BSPT
Page 1-82



3889
NPT
Page 1-82



3879
3979
BSPP
Page 1-82



3889
NPT
Page 1-82



Elbow - Inch

Tees

3803
3903
BSPT
Page 1-83



3803
NPT
Page 1-83



3893
3993
BSPP/Metric
Page 1-83



3808
3908
BSPT
Page 1-83



3808
NPT
Page 1-84



3898
3998
BSPP/Metric
Page 1-84



Tube-to-Tube Fittings

Straight

3806
3906
Page 1-85



Straight - Inch

3806
3906
Page 1-85



Elbow

3802
3902
Page 1-85



Elbow - Inch

3802
3902
Page 1-85



Tee

3804
3904
Page 1-85



Tee - Inch

3804
Page 1-86



Bulkhead Connector Fittings

Straight

3816
3916
Page 1-86



Straight - Inch

3816
3916
Page 1-86



Plug-In Fittings and Accessories

3866
3966
Reducer
Page 1-87



3826
Plug
Page 1-87



Accessories

3800 70
Page 1-87



0605
Page 1-87



3000 70
Page 1-87



LF 3800/LF 3900 Push-In Fittings

Parker Legris has developed two ranges of **stainless steel fittings (LF 3800 or LF 3900 in full 316L)** for conveying corrosive fluids in **aggressive environments**. These ranges provide two complementary levels of corrosion resistance and a **hygienic external design**.

Product Advantages

- High Resistance to Aggressive Environments**
 - LF 3800: excellent for conveying aggressive fluids
 - LF 3900: maximum chemical resistance to internal and external corrosion
 - Hygienic external design for reducing retention zones
 - Easy cleaning in situ
 - Proven gripping technology
- Wide Range of Applications**
 - Perfect for permanent contact with foodstuffs
 - Compatible with frequent sterilization
 - Excellent in saline environments and outdoor applications
 - Resistant to industrial cleaning agents and detergents
 - Compatible with polymer and grooved stainless steel tubing
 - One fitting for many applications: optimised stock management
- Reliability & Safety**
 - All-metal product allowing detection of all components
 - Full bore, with minimal pressure drop
 - Resistant to hammering, mechanical shock and impulse
 - Manual connection and disconnection, no tools required
 - 100% leak-tested in production
 - Date coding to guarantee quality and traceability
 - IP 51 bulkhead: complete protection against ingress in food and non-food zones



Applications

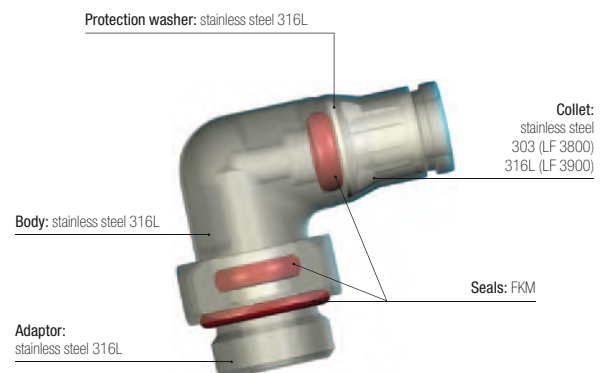
- Food Process
- Paper Industry
- Petrochemical
- Pharmaceutical
- Chemical
- Medical

Technical Characteristics

Compatible Fluids	All fluids compatible with the fitting and tubing component materials					
Working Pressure	Vacuum to 30 bar (20 bar: 3879/3979 and 3889/3989)					
Working Temperature	-20° to +150°C					
Adaptor Tightening Torque	Threads	M5x0.8	G1/8	G1/4	G3/8	G1/2
	daN.m	0.16	0.8	1.2	3	3.5
Bulkhead Tightening Torque	Ø (mm)	4	6	8	10	12
	daN.m min. max.	0.5 0.9	0.5 0.9	0.6 1	0.6 1	0.6 1

Reliable performance is dependent upon the type of fluid conveyed, component materials and tubing being used. Use is guaranteed with a vacuum of 755 mm Hg (99% vacuum).

Component Materials



Silicone-free


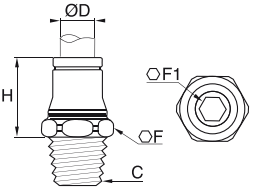


Regulations

- ISO 14743 Pneumatic transmissions, push-in fittings for thermoplastic tubing
- DI: 97/23/EC (PED)
- DI: 2002/95/EC (RoHS), 2011/65/EC
- DI: 94/9/EC (ATEX)
- RG: 1907/2006 (REACH)
- UL94 V-0: Seal
- RG: 21CFR (FDA)
- RG: 1935/2004/EC
- USDA NSF H1: Grease

Stud Fittings


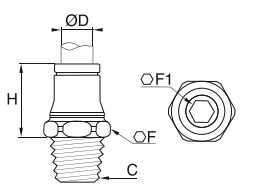

3805/3905

Stud Fitting, Male BSPT Thread

	Stainless steel 316L, FKM		ØD	C			F	F1	H	kg
			4	R1/8	3805 04 10	3905 04 10	10	3	14.5	0.008
				R1/4	3805 04 13	3905 04 13	14	3	14.5	0.016
			6	R1/8	3805 06 10	3905 06 10	13	4	18	0.012
				R1/4	3805 06 13	3905 06 13	14	4	16.5	0.018
			8	R1/8	3805 08 10	3905 08 10	15	5	19	0.015
				R1/4	3805 08 13	3905 08 13	15	6	18	0.018
				R3/8	3805 08 17	3905 08 17	17	6	18.5	0.025
			10	R1/4	3805 10 13	3905 10 13	19	6	24	0.029
				R3/8	3805 10 17	3905 10 17	19	6	22.5	0.031
				R1/4	3805 12 13	3905 12 13	22	7	25	0.035
			12	R3/8	3805 12 17	3905 12 17	22	8	24	0.038
				R1/2	3805 12 21	3905 12 21	22	10	23	0.046

3805


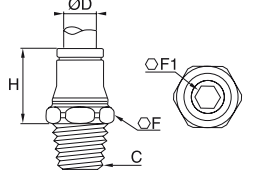

Stud Fitting, Male NPT Thread

	Stainless steel 316L, FKM		ØD	C		F	F1	H	kg
			4	NPT1/8	3805 04 11	11	3	14.5	0.009
				NPT1/8	3805 06 11	13	4	18	0.012
			6	NPT1/4	3805 06 14	14	4	16.5	0.017
				NPT1/8	3805 08 11	15	5	19	0.015
			8	NPT1/4	3805 08 14	15	6	18	0.019
				NPT1/4	3805 10 14	19	6	24	0.028
			10	NPT3/8	3805 10 18	19	7	22.5	0.031
				NPT1/4	3805 12 14	22	7	25	0.035
			12	NPT3/8	3805 12 18	22	8	24	0.039
				NPT1/2	3805 12 22	22	10	23	0.045

3805

Stud Fitting, Male NPT Thread


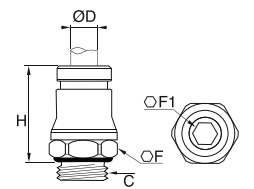


Inch

	Stainless steel 316L, FKM		ØD	C		F	F1	H	kg
			3/16	NPT1/8	3805 55 11	10	3	15.5	0.010
				NPT1/4	3805 55 14	14	3	15.5	0.016
			1/4	NPT1/8	3805 56 11	13	4	19	0.012
				NPT1/4	3805 56 14	14	4	17.5	0.017
			3/8	NPT1/4	3805 60 14	19	6	25	0.029
				NPT3/8	3805 60 18	19	7	24	0.032
				NPT1/4	3805 62 14	22	7	26	0.039
			1/2	NPT3/8	3805 62 18	22	8	25	0.042
				NPT1/2	3805 62 22	22	10	25	0.050

5/32" (4 mm) and 5/16" (8 mm) also available

3801/3901

Stud Fitting, Male BSPP and Metric Thread

	Stainless steel 316L, FKM		ØD	C			F	F1	H	kg
			4	M5x0.8	3801 04 19	3901 04 19	10	2.5	17	0.006
				G1/8	3801 04 10	3901 04 10	13	3	16.5	0.009
				M5x0.8	3801 06 19	3901 06 19	13	2.5	20.5	0.010
			6	G1/8	3801 06 10	3901 06 10	13	4	18	0.010
				G1/4	3801 06 13	3901 06 13	17	4	18	0.015
				G1/8	3801 08 10	3901 08 10	15	5	19	0.013
			8	G1/4	3801 08 13	3901 08 13	17	5	20.5	0.017
				G3/8	3801 08 17	3901 08 17	21	6	20	0.027
			10	G1/4	3801 10 13	3901 10 13	19	7	25	0.025
				G3/8	3801 10 17	3901 10 17	21	7	25	0.035
			12	G1/4	3801 12 13	3901 12 13	21	7	27	0.030
				G3/8	3801 12 17	3901 12 17	21	9	26.5	0.034

Other products are available upon request; please do not hesitate to consult us.

Stud Fittings

3821/3921 Stud Standpipe, Male BSPT Thread

ØD	C	LF		F	H	kg
		3821	3921			
4	R1/8	3821 04 10	3921 04 10	10	21	0.006
	R1/4	3821 06 10	3921 06 10	10	23	0.007
6	R1/8	3821 06 13	3921 06 13	14	24	0.015
	R1/4	3821 08 10	3921 08 10	11	24	0.008
8	R1/8	3821 08 13	3921 08 13	14	25	0.015
	R1/4	3821 10 13	3921 10 13	19	30	0.020
10	R3/8	3821 10 17	3921 10 17	19	30	0.022
	R1/4	3821 12 13	3921 12 13	19	31	0.017
12	R3/8	3821 12 17	3921 12 17	19	31	0.022
	R1/2	3821 12 21	3921 12 21	22	32	0.040

3821/3921 Stud Standpipe, Male NPT Thread

ØD	C	LF		F	H	kg
		3821	3921			
4	R1/8	3821 04 11	3921 04 11	10	21	0.006
	R1/4	3821 06 11	3921 06 11	10	23	0.008
6	R1/8	3821 06 14	3921 06 14	14	24	0.016
	R1/4	3821 08 11	3921 08 11	14	24	0.010
8	R1/8	3821 08 14	3921 08 14	14	25	0.016
	R1/4	3821 10 14	3921 10 14	14	30	0.016
10	R3/8	3821 10 18	3921 10 18	17	30	0.022
	R1/4	3821 12 14	3921 12 14	14	31	0.022
12	R3/8	3821 12 18	3921 12 18	17	31	0.026
	R1/2	3821 12 22	3921 12 22	22	32	0.052

3821 Stud Standpipe, Male NPT Thread

Inch

ØD	C	LF	F	H	kg
3/16	NPT1/8	3821 55 11	9.9	24.9	0.009
	NPT1/8	3821 56 11	9.9	25.9	0.009
1/4	NPT1/4	3821 56 14	14	26.9	0.018
	NPT1/4	3821 60 14	19	32	0.018
3/8	NPT3/8	3821 60 18	19	32	0.029
	NPT1/4	3821 62 14	19	36.1	0.033
1/2	NPT3/8	3821 62 18	19	37.1	0.037
	NPT1/2	3821 62 22	22.1	37.1	0.055

5/32" (4 mm) and 5/16" (8 mm) also available

3831/3931 Stud Standpipe, Male BSPP and Metric Thread

ØD	C	LF		F	H	K	kg
		3831	3931				
4	M5x0.8	3831 04 19	3931 04 19	7	23.5	8	0.005
	G1/8	3831 04 10	3931 04 10	13	22	14	0.008
6	G1/4	3831 04 13	3931 04 13	17	22	18.5	0.016
	G1/8	3831 06 10	3931 06 10	13	24	14	0.009
8	G1/4	3831 06 13	3931 06 13	17	24	18.5	0.015
	G1/8	3831 08 10	3931 08 10	13	25	14	0.010
10	G1/4	3831 08 13	3931 08 13	17	27	18.5	0.018
	G3/8	3831 08 17	3931 08 17	21	27	23	0.025
12	G1/4	3831 10 13	3931 10 13	17	32	18.5	0.020
	G3/8	3831 10 17	3931 10 17	21	27	23	0.026
12	G1/4	3831 12 13	3931 12 13	17	33	18.5	0.022
	G3/8	3831 12 17	3931 12 17	21	33	23	0.028
12	G1/2	3831 12 21	3931 12 21	24	36	26	0.043


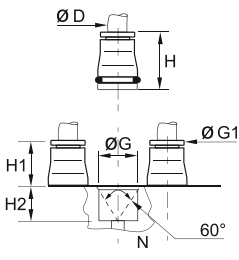
LF 3800 : full 316L stainless steel (body) with 303 stainless steel collet, FKM seals
 LF 3900 : full 316L, FKM seals

Stud Fittings

3800/3900

Cartridge

ØD	Stainless steel 316L, FKM		L	G	G1	H	H1	H2	kg
4	3800 04 00	3900 04 00	9.8	8	17	8.5	8.5	11	0.006
6	3800 06 00	3900 06 00	12.1	10	19	10.5	8.5	13.5	0.008
8	3800 08 00	3900 08 00	14.8	13	21	12.5	8.5	16	0.012
10	3800 10 00	3900 10 00	17.5	15	24.5	14	10.5	20	0.019
12	3800 12 00	3900 12 00	20	17	25	14.5	10.5	22.5	0.023


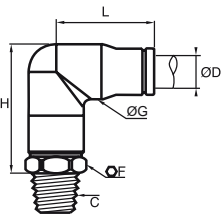



Cavity dimensions are available in Chapter 2.
 3800: collet in stainless steel 303
 3900: collet in stainless steel 316L

3809/3909

Stud Elbow, Male BSPT Thread

ØD	C	Stainless steel 316L, FKM		F	G	H	L	kg
4	R1/8	3809 04 10	3909 04 10	10	10	23.5	16.5	0.020
	R1/8	3809 06 10	3909 06 10	13	12	27.5	20	0.031
6	R1/4	3809 06 13	3909 06 13	14	12	27.5	25	0.036
	R1/8	3809 08 10	3909 08 10	14	15	32	25	0.041
8	R1/4	3809 08 13	3909 08 13	14	14.5	34	25	0.046
	R1/4	3809 10 13	3909 10 13	19	17.5	37.5	27.5	0.068
10	R3/8	3809 10 17	3909 10 17	19	17.5	37.5	27.5	0.069


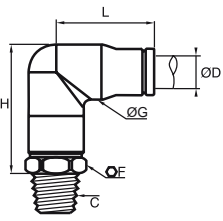



The body swivels for positioning purposes.

3809

Stud Elbow, Male NPT Thread

ØD	C	Stainless steel 316L, FKM		F	G	H	L	kg
4	NPT1/8	3809 04 11		11	10	25.5	18.5	0.021
	NPT1/8	3809 06 11		13	12.5	29	22.5	0.025
6	NPT1/4	3809 06 14		14	12.5	29	22.5	0.030
	NPT1/8	3809 08 11		14	15	34	24	0.041
8	NPT1/4	3809 08 14		14	15	34	24	0.046
	NPT1/4	3809 10 14		19	17.5	39.5	30	0.057
10	NPT3/8	3809 10 18		19	17.5	39.5	30	0.071


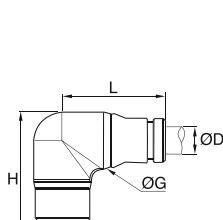



The body swivels for positioning purposes.

3899/3999

Stud Elbow, Male BSPP and Metric Thread

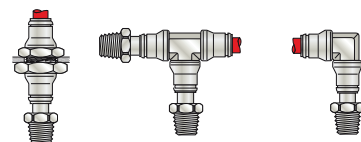
ØD	C	Stainless steel 316L, FKM		F	G	H	L	kg
4	M5x0.8	3899 04 19	3999 04 19	10	10	26	18	0.019
	G1/8	3899 04 10	3999 04 10	13	10	27	19	0.021
	G1/4	3899 04 13	3999 04 13	17	10	27	19	0.018
6	M5x0.8	3899 06 19	3999 06 19	13	12	33	24	0.031
	G1/8	3899 06 10	3999 06 10	6	12	33	24	0.031
	G1/4	3899 06 13	3999 06 13	17	12	32	24	0.035
8	G1/8	3899 08 10	3999 08 10	14	15	35	25	0.039
	G1/4	3899 08 13	3999 08 13	17	15	35	25	0.044
	G3/8	3899 08 17	3999 08 17	21	15	34.5	25	0.048
10	G1/4	3899 10 13	3999 10 13	19	17	43	31	0.068
	G3/8	3899 10 17	3999 10 17	21	17	42	31	0.072

The body swivels for positioning purposes.

Stud standpipe 3821, 3921, 3831, 3931 can be used as illustrated, allowing:


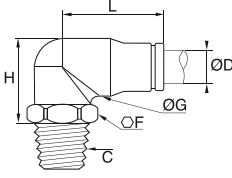


- stock optimisation
- installation of tees and elbows where required



Stud Fittings

3889/3989


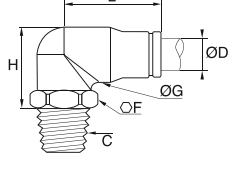

Compact Stud Elbow, Male BSPT Thread

	Stainless steel 316L, FKM			ØD	C			F	G	H	L	kg
	4	R1/8		3889 04 10	3989 04 10	13	10	18	17	0.018		
		R1/4		3889 04 13	3989 04 13	17	10	19.5	16.5	0.025		
	6	R1/8		3889 06 10	3989 06 10	13	12	21.5	20.5	0.026		
		R1/4		3889 06 13	3989 06 13	14	12	21.5	20.5	0.032		
	8	R1/8		3889 08 10	3989 08 10	14	15	24	22	0.036		
		R1/4		3889 08 13	3989 08 13	14	15	24	22	0.041		
	10	R1/4		3889 10 13	3989 10 13	17	17.5	28.5	27.5	0.057		
		R3/8		3889 10 17	3989 10 17	19	17.5	28.5	27.5	0.062		
	12	R1/4		3889 12 13	3989 12 13	22	20	33.5	30	0.086		
		R3/8		3889 12 17	3989 12 17	22	20	33.5	30	0.088		
		R1/2		3889 12 21	3989 12 21	22	20	33.5	33	0.095		

The body swivels for positioning purposes.
Max. 20 bar

3889

Compact Stud Elbow, Male NPT Thread


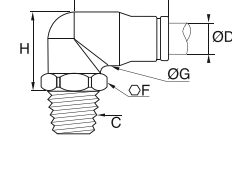

	Stainless steel 316L, FKM			ØD	C		F	G	H	L	kg
	4	NPT1/8		3889 04 11	13	10	17.5	19	0.019		
		NPT1/8		3889 06 11	13	12.5	20	22.5	0.020		
	6	NPT1/4		3889 06 14	14	12.5	20	22.5	0.033		
		NPT1/8		3889 08 11	13	15	25	24	0.037		
	8	NPT1/4		3889 08 14	14	15	24	24	0.037		
		NPT1/4		3889 10 14	17	17.5	27.5	27.5	0.058		
	10	NPT3/8		3889 10 18	19	17.5	28.5	26.5	0.067		
		NPT1/4		3889 12 14	22	20	31.5	32.5	0.070		
	12	NPT3/8		3889 12 18	22	20	32.5	32.5	0.087		
		NPT1/2		3889 12 22	22	20	27.5	32.5	0.072		

The body swivels for positioning purposes.
Max. 20 bar

3889

Compact Stud Elbow, Male NPT Thread


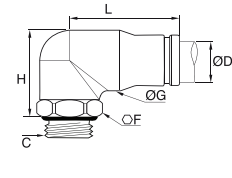


Inch

	Stainless steel 316L, FKM			ØD	C		F	G	H	L	kg
	3/16	NPT1/8		3889 55 11	10	9.9	20.6	19.6	0.019		
		NPT1/4		3889 55 14	14	9.9	20.6	19.6	0.022		
	1/4	NPT1/8		3889 56 11	13	11.9	21.6	23.1	0.026		
		NPT1/4		3889 56 14	14	11.9	21.6	23.1	0.031		
	3/8	NPT1/4		3889 60 14	17	17.5	28.4	30.5	0.059		
		NPT3/8		3889 60 18	19	17.5	28.4	30.5	0.062		
	1/2	NPT1/4		3889 62 14	22	20.1	34	33	0.086		
		NPT3/8		3889 62 18	22	20.1	34	33	0.088		
		NPT1/2		3889 62 22	22	20.1	27.2	33	0.091		

The body swivels for positioning purposes; 5/32" (4 mm) and 5/16" (8 mm) also available.
Max. 20 bar

3879/3979

Compact Stud Elbow, Male BSPP Thread


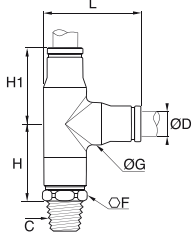


	Stainless steel 316L, FKM			ØD	C			F	G	H	L	kg
	4	G1/8		3879 04 10	3979 04 10	10	11	22	19	0.021		
		G1/4		3879 04 13	3979 04 13	17	11	20	19	0.026		
	6	G1/8		3879 06 10	3979 06 10	13	12	24	24	0.029		
		G1/4		3879 06 13	3979 06 13	17	12	22	24	0.034		
	8	G1/8		3879 08 10	3979 08 10	13	15	25	25	0.035		
		G1/4		3879 08 13	3979 08 13	17	15	25	25	0.040		
	10	G3/8		3879 08 17	3979 08 17	21	15	23	25	0.048		
		G1/4		3879 10 13	3979 10 13	18	17	43	31	0.056		
		G3/8		3879 10 17	3979 10 17	21	17	40	31	0.067		
	12	G1/4		3879 12 13	3979 12 13	17	20	33	33	0.075		
		G3/8		3879 12 17	3979 12 17	21	20	33	33	0.082		
		G1/2		3879 12 21	3979 12 21	24	20	30	33	0.094		

The body swivels for positioning purposes.
Max. 20 bar

Stud Fittings

3803/3903


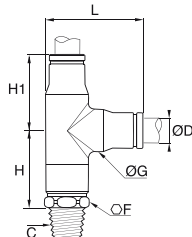

Stud Run Tee, Male BSPT Thread

	Stainless steel 316L, FKM		ØD	C			F	G	H	H1	L	kg
			4	R1/8	3803 04 10	3903 04 10	10	10	19	17	22	0.020
			6	R1/8	3803 06 10	3903 06 10	13	12	22	20	26.5	0.038
				R1/4	3803 06 13	3903 06 13	14	15	22	20	27	0.035
			8	R1/8	3803 08 10	3903 08 10	14	15	24	23	31	0.050
				R1/4	3803 08 13	3903 08 13	14	15	24	23	31	0.055
			10	R1/4	3803 10 13	3903 10 13	19	17.5	30	29	38	0.070
				R3/8	3803 10 17	3903 10 17	19	17.5	30	29	38	0.084

The body swivels for positioning purposes.

3803


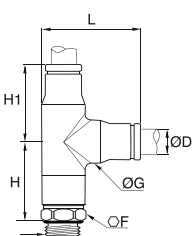


Stud Run Tee, Male NPT Thread

	Stainless steel 316L, FKM		ØD	C		F	G	H	H1	L	kg
			4	NPT1/8	3803 04 11	11	10	21	19	25	0.020
			6	NPT1/8	3803 06 11	13	12	24	21	27	0.031
				NPT1/4	3803 06 14	14	12	24	21	27.5	0.037
			8	NPT1/8	3803 08 11	14	15	26.5	24	30.5	0.050
				NPT1/4	3803 08 14	14	15	26.5	24	30.5	0.048
			10	NPT1/4	3803 10 14	19	17.5	31	29.5	37.5	0.084

The body swivels for positioning purposes.

3893/3993


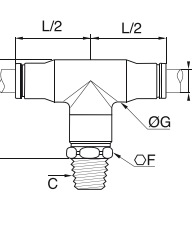


Stud Run Tee, Male BSPP and Metric Thread

	Stainless steel 316L, FKM		ØD	C			F	G	H	H1	L	kg
			4	M5x0.8	3893 04 19	3993 04 19	10	11	21.5	19	24.5	0.023
G1/8	3893 04 10	3993 04 10		13	11	21.5	19	24.5	0.026			
G1/4	3893 04 13	3993 04 13		17	11	22	19	28	0.033			
			6	G1/8	3893 06 10	3993 06 10	13	12	26.5	24	30	0.038
				G1/4	3893 06 13	3993 06 13	17	12	26	24	32	0.044
			8	G1/8	3893 08 10	3993 08 10	14	15	27.5	25	32	0.049
				G1/8	3893 08 13	3993 08 13	17	15	28	25	33.5	0.054
			10	G3/8	3893 08 17	3993 08 17	21	15	27	25	35.5	0.094
				G1/4	3893 10 13	3993 10 13	19	17	35.5	31	39.5	0.081
				G3/8	3893 10 17	3993 10 17	21	17	35.5	31	39.5	0.082

The body swivels for positioning purposes.

3808/3908

Stud Branch Tee, Male BSPT Thread

	Stainless steel 316L, FKM		ØD	C			F	G	H	L/2	kg
			4	R1/8	3808 04 10	3908 04 10	10	10	23.5	19	0.020
			6	R1/8	3808 06 10	3908 06 10	13	12	27.5	24	0.038
				R1/4	3808 06 13	3908 06 13	14	12	27.5	24	0.043
			8	R1/8	3808 08 10	3908 08 10	14	15	32	25	0.049
				R1/4	3808 08 13	3908 08 13	14	15	32	25	0.048
			10	R3/8	3808 08 17	3908 08 17	19	15	33	25	0.068
				R1/4	3808 10 13	3908 10 13	19	17.5	37.5	31	0.081
				R3/8	3808 10 17	3908 10 17	19	17.5	37.5	31	0.070

The body swivels for positioning purposes.

These models enable compact connection for elbow outlets, thus allowing space saving.

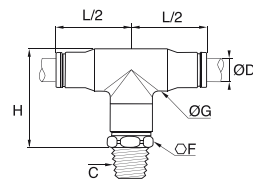
Stud Fittings

3808

Stud Branch Tee, Male NPT Thread



Stainless steel 316L, FKM



ØD	C		F	G	H	L/2	kg
4	NPT1/8	3808 04 11	11	10	22	19	0.021
6	NPT1/8	3808 06 11	13	12.5	30	24	0.031
	NPT1/4	3808 06 14	14	12.5	30	24	0.044
8	NPT1/8	3808 08 11	14	15	34	25	0.042
	NPT1/4	3808 08 14	14	15	34	25	0.048
10	NPT1/4	3808 10 14	19	17.5	40	31	0.069
	NPT3/8	3808 10 18	19	17.5	40	31	0.084

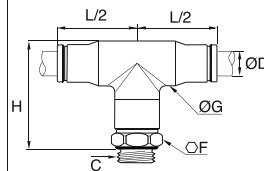
The body swivels for positioning purposes.

3898/3998

Stud Branch Tee, Male BSPP and Metric Thread



Stainless steel 316L, FKM




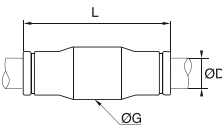


ØD	C			F	G	H	L/2	kg
4	M5x0.8	3898 04 19	3998 04 19	10	11	27	19	0.024
	G1/8	3898 04 10	3998 04 10	13	11	27	19	0.026
	G1/4	3898 04 13	3998 04 13	17	11	27	19	0.032
6	M5x0.8	3898 06 19	3998 06 19	13	12	33.5	24	0.038
	G1/8	3898 06 10	3998 06 10	13	12	33	24	0.038
	G1/4	3898 06 13	3998 06 13	17	12	32	24	0.043
8	G1/8	3898 08 10	3998 08 10	14	15	35	25	0.051
	G1/4	3898 08 13	3998 08 13	17	15	35	25	0.054
	G3/8	3898 08 17	3998 08 17	21	15	34.5	25	0.058
10	G1/4	3898 10 13	3998 10 13	19	17	43	31	0.082
	G3/8	3898 10 17	3998 10 17	21	17	41	31	0.087

The body swivels for positioning purposes.


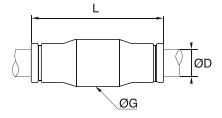


LF 3800 : full 316L stainless steel (body) with 303 stainless steel collet, FKM seals
 LF 3900 : full 316L, FKM seals

Tube-to-Tube Fittings

3806/3906 Equal Straight Connector


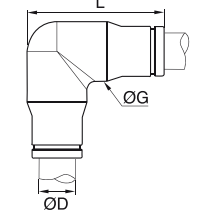


	Stainless steel 316L, FKM 	ØD			G	L	kg
		4	3806 04 00	3906 04 00	10	29	0.009
		6	3806 06 00	3906 06 00	12	34	0.015
		8	3806 08 00	3906 08 00	15	36	0.019
		10	3806 10 00	3906 10 00	17.5	45	0.032
		12	3806 12 00	3906 12 00	20	46.5	0.041

3806/3906 Equal Straight Connector Inch


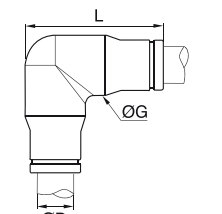


	Stainless steel 316L, FKM 	ØD			G	L	kg
		3/16	3806 55 00	3906 55 00	9.9	30	0.010
		1/4	3806 56 00	3906 56 00	11.9	35.1	0.015
		3/8	3806 60 00	3906 60 00	17.5	46	0.030
		1/2	3806 62 00	3906 62 00	20.1	48	0.040

5/32" (4 mm) and 5/16" (8 mm) also available

3802/3902 Equal Stud Elbow


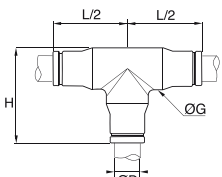


	Stainless steel 316L, FKM 	ØD			G	L	kg
		4	3802 04 00	3902 04 00	10	21.5	0.015
		6	3802 06 00	3902 06 00	12	26.5	0.024
		8	3802 08 00	3902 08 00	15	29.5	0.031
		10	3802 10 00	3902 10 00	17.5	36.5	0.051
		12	3802 12 00	3902 12 00	20	40	0.069

3802/3902 Equal Stud Elbow Inch

	Stainless steel 316L, FKM 	ØD			G	L	kg
		3/16	3802 55 00	3902 55 00	9.9	24.4	0.011
		1/4	3802 56 00	3902 56 00	11.9	29	0.023
		3/8	3802 60 00	3902 60 00	17.5	39.6	0.042
		1/2	3802 62 00	3902 62 00	20.1	40.9	0.070

5/32" (4 mm) and 5/16" (8 mm) also available

3804/3904 Equal Tee

	Stainless steel 316L, FKM 	ØD			G	L	L/2	kg
		4	3804 04 00	3904 04 00	10	22	19	0.015
		6	3804 06 00	3904 06 00	12	26	24	0.031
		8	3804 08 00	3904 08 00	15	29.5	25	0.041
		10	3804 10 00	3904 10 00	17.5	36.5	31	0.064
		12	3804 12 00	3904 12 00	20	40	33	0.064

Bulkhead Connector Fittings

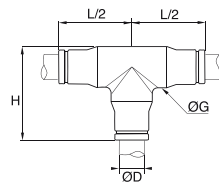
3804/3904

Equal Tee

Inch



Stainless steel 316L, FKM



ØD			G	H	L/2	kg
3/16	3804 55 00	3904 55 00	9.9	22.6	19	0.017
1/4	3804 56 00	3904 56 00	11.9	26.9	22	0.031
3/8	3804 60 00	3904 60 00	17.5	37.6	30	0.059
1/2	3804 62 00	3904 62 00	20.1	40.9	32	0.090

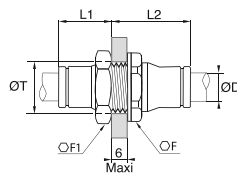
5/32" (4 mm) and 5/16" (8 mm) also available

3816/3916

Equal Bulkhead Connector



Stainless steel 316L, FKM



ØD			F	F1	L1	L2	ØT	kg
4	3816 04 00	3916 04 00	13	14	13.5	19.5	13	0.017
6	3816 06 00	3916 06 00	17	17	16.5	21.5	14	0.027
8	3816 08 00	3916 08 00	19	19	18	24	16	0.034
10	3816 10 00	3916 10 00	22	22	21.5	27.5	21	0.049
12	3816 12 00	3916 12 00	24	24	24	29	23	0.059

IP51 sealing

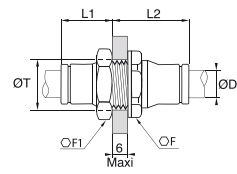
3816/3916

Equal Bulkhead Connector

Inch



Stainless steel 316L, FKM



ØD			F	F1	L1	L2	ØT	kg
3/16	3816 55 00	3916 55 00	17	13	15	21.1	12.4	0.019
1/4	3816 56 00	3916 56 00	19	17	17	22.6	14.5	0.027
3/8	3816 60 00	3916 60 00	27	22	22.1	27.4	20.6	0.052
1/2	3816 62 00	3916 62 00	27	27	20	29	20.1	0.076

IP51 sealing

5/32" (4 mm) and 5/16" (8 mm) also available


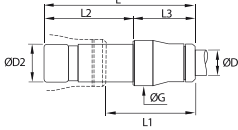


LF 3800/LF 3900 push-in fittings allow connection with several types of Parker Legris tubing shown in Chapter 3 of this catalogue, "Technical Tubing and Hose":

- PFA tubing
- Fluoropolymer tubing
- Polyethylene tubing
- Semi-rigid polyamide and flexible Crystal polyurethane tubing

Plug-In Fittings and Accessories


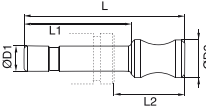

3866/3966

Push-In Reducer

	Stainless steel 316L, FKM		ØD1	ØD2			G	L	L1	L2	L3	kg
			4	6	3866 04 06	3966 04 06	10	35	19	19	16	0.009
			4	8	3866 04 08	3966 04 08	10	34	17	20	14	0.011
			6	8	3866 06 08	3966 06 08	12	42	24	23	19	0.015
			6	10	3866 06 10	3966 06 10	12	41	19	25	16	0.019
			8	10	3866 08 10	3966 08 10	15	45	22.5	25	20	0.021
			8	12	3866 08 12	3966 08 12	15	43	20	26	17	0.025
			10	12	3866 10 12	3966 10 12	17	50	23	26	24	0.029


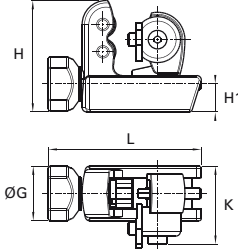


3826

Blanking Plug

	Stainless steel 316L		ØD1	ØD2		L	L1	L2	kg
			4	6	3826 04 00	25	17	11	0.003
			6	8	3826 06 00	30.4	19.5	13.5	0.007
			8	10	3826 08 00	33	20	14	0.014
			10	12	3826 10 00	40	25	17	0.025
			12	14	3826 12 00	43	26	19	0.038

3800/3900



Pre-Grooving Tool for Stainless Steel Tubing

	Treated steel				G	H	H1	K	L	kg
			3800 70 00	3900 70 00	25	51	13	36	70	0.326

This tool correctly pre-grooves 4-12 mm O.D. and 3/16"-1/2" O.D. stainless steel tubing, to ensure that the LF 3800/LF 3900 collet grips the tube securely.

0605


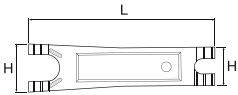

Fluoropolymer Tape

	FKM		kg
		0605 12 12	0.012

Can be used for temperatures from -250°C to +260°C.
Chemically inert and resistant to gases, acids, solvents, hydrocarbons, oils, alkalines, steam, etc.
Non-toxic, waterproof, self-lubricating.
In accordance with CFR21.
Can be used on all materials.
Used to facilitate the preparation of leak-free threaded joints.
Supplied on a reel: length = 12 m; width = 12.7 mm; thickness = 0.08 mm.

3000

Disconnection Tool

	Treated steel			H	H1	L	kg
			3000 70 00	25	20	96	0.021

For disconnecting push-in tubing/fittings where access is difficult, we recommend the use of this disconnection tool.

LF 6100 Push-In Fittings Range

Stud Fittings

Straights

6105

BSPT/Metric Taper
Page 1-91



6101

Metric Parallel
Page 1-91



6114

Metric Parallel
Page 1-91



Elbow

6179

BSPT Metric Taper
Page 1-91



Tube-to-Tube Fittings

Straight

6106

Page 1-92



Tee

6104

Page 1-92



Accessory

0138

Page 1-92



LF 6100 Push-In Fittings

This fittings range dedicated to **lubrication and vacuum systems**, combines very high performance and manual connection. This technology **secures the connection** and sealing performance, even at high pressure.

Product Advantages

Robust | Designed for mechanically demanding environments
 Excellent pressure and temperature resistance
 Stamped brass forgings for increased service life

Secure & Reliable | Perfect sealing guaranteed by the three rings
 The two sealing O-rings positioned before the gripping ring endure no scratching on the tube in the sealing area
 Manual connection for time-saving
 No fluid loss
 Tube cannot be disconnected without the use of a spanner
 Up to 60 bar with rigid polymer or grooved metal tubing
 100% leak-tested in production



Construction Equipment
 Lubrication
 Transportation
 Measurement Systems
 Industrial Machines
 Industrial Vacuum

Applications

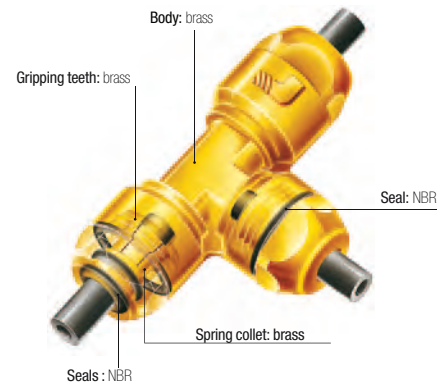
Technical Characteristics

Compatible Fluids	Lubricants, compressed air, vacuum, other fluids and compatible gases
Working Pressure	Vacuum to 60 bar
Working Temperature	-20° to +120°C

Max./Min. Tightening Torques (daN.m)	Thread	M6 x1	M8 x1	M8 x1.25	M10 x1	M12 x1	M14 x1.5	R 1/8	R 1/4
	Taper	0.2/0.6	0.2/1.2	0.2/1	0.2/1.2	0.2/2	0.5/1.5	0.2/1.0	0.5/1.5
	Parallel	-	0.6/1	-	0.6/1	1.8/2.2	-	-	-

Reliable performance is dependent upon the type of fluid conveyed, component materials and tubing being used.
 Use is guaranteed with a vacuum of 755 mm Hg (99% vacuum).

Component Materials



Silicone-free

Regulations

DI: 97/23/EC (PED)
 DI: 2002/95/EC (RoHS),
 2011/65/EC

DI: 94/9/EC (ATEX)
 RG: 1907/2006 (REACH)

Performance


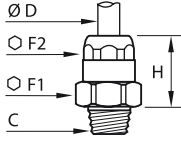

Working Pressure / Temperature According to the Tubing Used

O.D. of Tube	-20°C to +20°C		+20°C to +30°C		+30°C to +50°C		+50°C to +80°C		+80°C to 120°C
	Semi-Rigid PA	Rigid PA	Semi-Rigid PA	Rigid PA	Semi-Rigid PA	Rigid PA	Semi-Rigid PA	Rigid PA	FEP
2x4	40	-	33	-	25.5	-	19	-	-
2.5x4	-	52	-	43	-	32	-	24.5	7
2.7x4	23	-	19	-	15	-	11	-	-
4x6	24	45	20	37	15.5	29	11	21	6
5x8	-	52	-	43	-	33	-	24	-
6x8	17	32	14	27	11	21	8	15	4
6x10	-	57	-	47	-	37	-	27	-
7.5x10	17	-	14	-	11	-	8	-	-
8x10	14	-	12	-	9	-	7	-	3


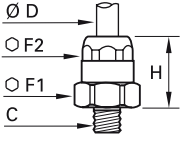

Should your requirement not be covered by our standard range, please consult us for customised fittings.

Stud Fittings


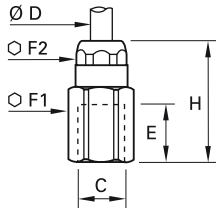

6105 Stud Fitting, Male BSPT and Taper Metric Thread

	Brass, NBR 	ØD	C		F1	F2	H	kg
		4	M6x1	6105 04 52	13	11	16.5	0.013
		4	M8x1	6105 04 56	13	11	14.5	0.012
		4	M8x1.25	6105 04 57	13	11	14.5	0.012
		4	M10x1	6105 04 60	13	11	14.5	0.014
		4	R1/8	6105 04 10	13	11	14.5	0.014
		4	R1/4	6105 04 13	14	11	12.5	0.018
		6	M10x1	6105 06 60	17	14	16.5	0.024
		6	R1/8	6105 06 10	17	14	17.5	0.026
		6	M14x1.5	6105 06 71	17	14	16.5	0.028
		6	R1/4	6105 06 13	17	14	16.5	0.030
		8	M12x1	6105 08 65	19	21	24	0.041
		10	M14x1.5	6105 10 71	22	24	26	0.005


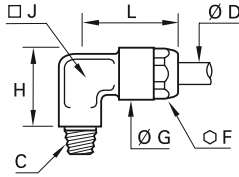

6101 Stud Fitting, Male Parallel and Metric Thread

	Brass, NBR 	ØD	C		F1	F2	H	kg
		4	M10x1	6101 04 60	13	11	14	0.014
		6	M10x1	6101 06 60	17	14	17.5	0.026
			M12x1	6101 06 65	17	14	16.5	0.025

6114 Stud Fitting, Female Metric Parallel Thread


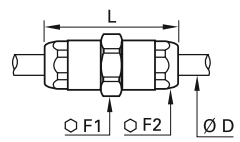

	Brass, NBR 	ØD	C		E	F1	F2	H	kg
		4	M8x1	6114 04 56	8	13	11	25.5	0.021
		6	M8x1	6114 06 56	8	17	14	28.5	0.043

6179 Stud Elbow, Male BSPT and Taper Metric Thread


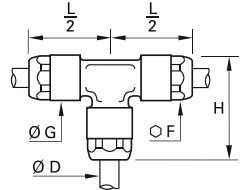

	Brass, NBR 	ØD	C		F	G	H	J	L	kg	
		4	M6x1	6179 04 52	11	12.5	14.5	6	20	0.014	
			M8x1	6179 04 56	11	12.5	15	6	20	0.015	
			M8x1.25	6179 04 57	11	12.5	15	6	20	0.015	
			M10x1	6179 04 60	11	12.5	15.5	6	20	0.016	
			R1/8	6179 04 10	11	12.5	15.5	6	20	0.017	
			R1/4	6179 04 13	11	12.5	17	6	20	0.022	
		6	M10x1	6179 06 60	14	16	18	8	25.5	0.030	
			M12x1	6179 06 65	14	16	18	8	25.5	0.030	
			R1/8	6179 06 10	14	16	18	8	25.5	0.030	
			R1/4	6179 06 13	14	16	19	8	25.5	0.035	
			8	M12x1	6179 08 65	17	19	21	10	30	0.047

Tube-to-Tube Fittings


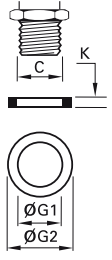

6106 Tube-to-Tube Connector

	Brass, NBR 	ØD 	F1	F2	L	kg
		4	13	11	34	0.025
		6	17	14	39	0.044
		8	19	17	46	0.069

6104 Equal Tee

	Brass, NBR 	ØD 	F	G	H	L/2	kg
		4	11	12.5	26.5	20	0.032
		6	14	16	32.5	25.5	0.066
		8	17	19	38	30	0.103

0138 Copper Washer

	Copper 	C 	G1	G2	K	kg
		M8	8.3	11	1	0.001
		M10	10.3	13.5	1	0.001
		M12	12.3	15.5	1.3	0.072

DIN 7603
ISO 65061

Related Products

The Parker Legris push-in system for centralised lubrication is designed for use with various polymer tubing found in Chapter 3, "Technical Tubing and Hose":

- Fireproof High Resistance PA Tubing
- Rigid and Semi-Rigid Calibrated Polyamide Tubing
- Fluoropolymer Tubing



Cartridges and Customised Products



PARKER LEGRIS Industrial Connector Systems

Products are available from:

MARYLAND METRICS

P.O. Box 261 Owings Mills, MD 21117 USA email: sales@mdmetric.com

ph: (410)358-3130 (800)638-1830 fx: (410)358-3142 (800)872-9329

web: <http://mdmetric.com> RFQ form: <http://mdmetric.com/rfq.htm>

How to order: Please preface each PARKER LEGRIS Catalog part number with 'R053-' Example: R053-3175 04 10





Cartridges

Polymer Cartridges

Compressed Air

- 3100** Carstick® Page 2-8
- 3086** Quick Fitting Page 2-8
- 3089** Quick Fitting Page 2-8
- 3082** Quick Fitting Page 2-8
- 3081** Quick Fitting Page 2-9
- 3088** Quick Fitting Page 2-9
- 3100 - Inch** Carstick® Page 2-8



Fluids and Gases

- 6300** Carstick® LIQUIfit® Page 2-10
- 6300 - Inch** Carstick® LIQUIfit® Page 2-10



Metal Cartridges

Fluids and Gases

- 3600** Page 2-13
- 3800** Page 2-13
- 3900** Page 2-13
- TL** Page 2-13
- TLT** Disconnection Tool Page 2-13



Polymer Cartridges: LF 3000® and LIQUIfit® Carstick®, Quick Fitting

Parker Legris has developed the range of patented **Carstick®** cartridges guaranteeing **the integrity of the sealing system** before and after assembly in non-threaded cavities. The **compact design** of the one-piece Carstick® cartridge enables **automation** of your manufacturing process and improves the **reliability** of your system.

Product Advantages

- Time-Saving**
 - No thread to be machined for inserting the fitting into its cavity
 - Seal pre-assembled, greased and protected
 - Self-centring of the cartridge in the cavity
 - Product protected against contamination, from manufacture to installation
 - Possible to have several diameters of tube in the same cavity (Quick Fitting)
- Proven Technology**
 - Technical performances of the LF 3000®
 - Push-in connection
 - Full flow
 - Optimum flow at pressure and vacuum
 - LIQUIfit® Carstick® compatible with drinking water and food fluids
- Automated Installation**
 - Ensures that the product will be correctly assembled
 - Connection fully integrated in the cavity
 - Carstick® packaging designed for an automatic assembly process

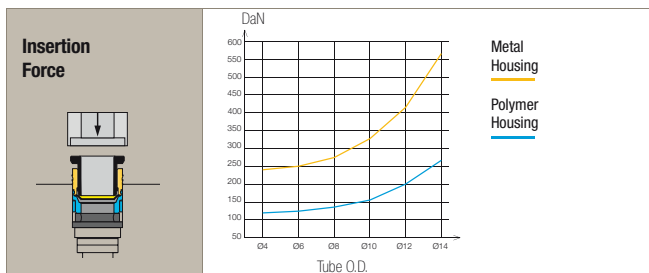


- Applications**
- Robotics
 - Automotive Process
 - Pneumatics
 - Semi-Conductors
 - Water & Beverage
 - Packaging
 - Vacuum

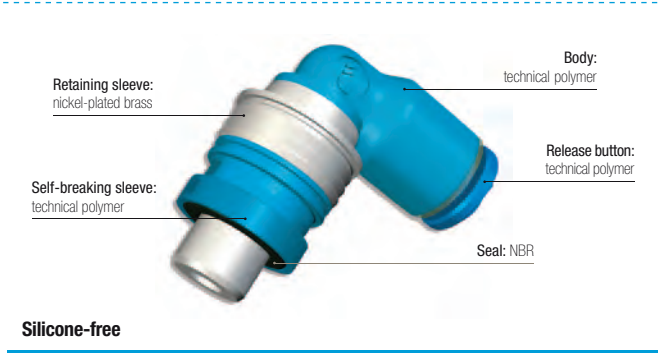
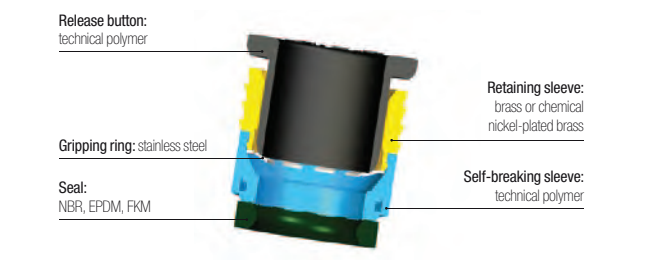
Technical Characteristics

	LF 3000® Carstick® and Quick Fitting	LIQUIfit® Carstick®
Compatible Fluids	Compressed air	Food fluids, inert gases
Working Pressure	Vacuum to 20 bar	Vacuum to 16 bar*
Working Temperature	-20°C to +80°C	-10°C to +95°C*

Reliable performance is dependent upon the type of fluid conveyed, component materials and tubing being used. Guaranteed for use with a vacuum of 755 mm Hg (99% vacuum). *The pressure/temperature information is shown in Chapter 1, in the "LIQUIfit®" section.



Component Materials



Silicone-free

Regulations

LF 3000® Carstick® and Quick Fitting
 ISO 14743: Pneumatic fluid power, push-in fittings for thermoplastic tubes
 DI: 2002/95/CE (RoHS), 2011/65/CE
 DI: 97/23/CE (PED)

LIQUIfit® Carstick®
 RG: 1935/2004/CE
 FDA: 21 CFR 177.1550
 NSF 51 to 95°C
 ACS
 DM 174 (Italy)

DI: 2002/95/CE (RoHS), 2011/65/CE
 DI: 97/23/CE (PED)
 WRAS
 NSF/ANSI 61 - C HOT
 KTW: cartridges on request

Assembly Options

Cartridge solutions quickly pay for themselves when they enable production to be rationalised:

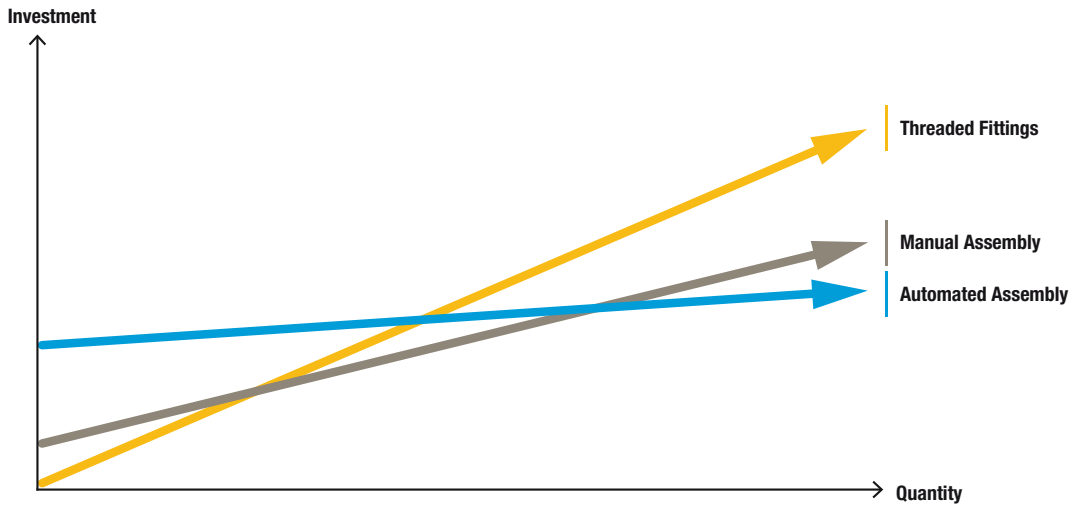
Threaded Fittings
For small quantities or non-standard assembly operations:
 The threaded solution remains the most advantageous.



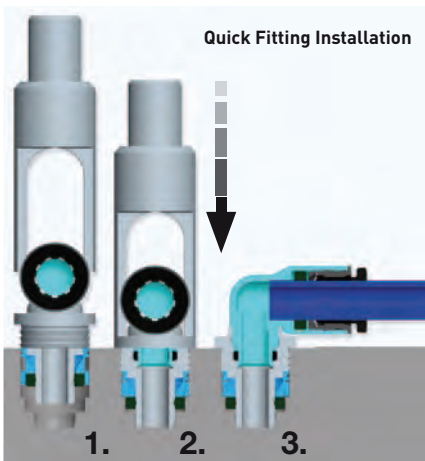
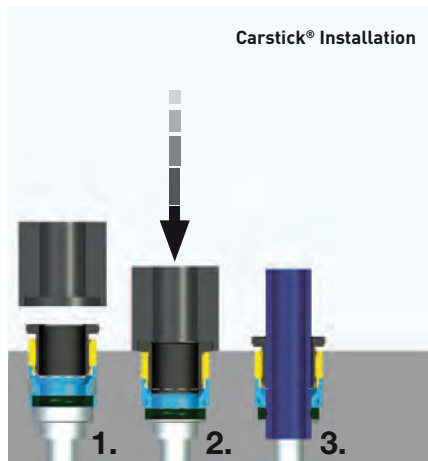
Carstick®: Manual Assembly
For medium quantities:
 Assembly by manually-operated press offers the most economic solution.



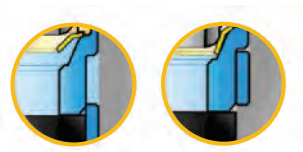
Carstick®: Automated Assembly
For repetitive operations and large quantities:
 Investment in an automated manufacturing solution is quickly recovered, providing significant long-term savings.



Installation



1. Self-centering of the cartridge in the cavity.
2. The seal protection is broken. The seal slides into the cavity. The cartridge is in place.



3. Tube connection.

Assembly tool:
 For details on the assembly tool, please contact us.


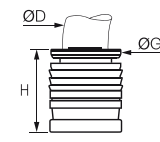




Assembly tool:
 For details on the assembly tool, please contact us.


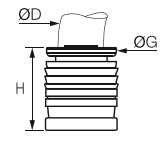

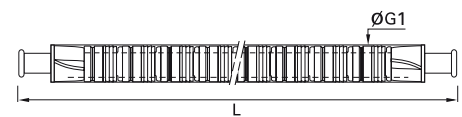


Polymer Cartridges for Compressed Air


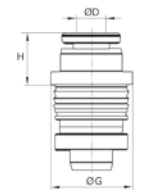

3100 Carstick® Cartridge

	Brass, NBR 	ØD		G	G1	H	L	kg
		4	3100 04 00	8	11	10	554	0.001
		6	3100 06 00	10	14.5	11.5	629	0.002
		8	3100 08 00	13	15	15	794	0.002
		10	3100 10 00	15.5	19.5	17	930	0.005
		12	3100 12 00	19.5	21	19.5	1038	0.010
50 cartridges per Carstick®								
								


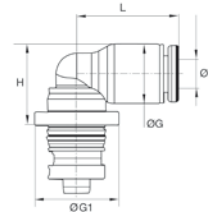

3100 Carstick® Cartridge

	Nickel-plated brass, NBR 	ØD		G	G1	H	L	kg
		1/8	3100 53 00 99	7	10	9	508	0.002
		1/4	3100 56 00 99	10.5	14.5	12	600	0.003
		3/8	3100 60 00 99	15.5	19	16.5	930	0.006
50 cartridges per Carstick®								
5/32" (4 mm) and 5/16" (8 mm) also available								
								


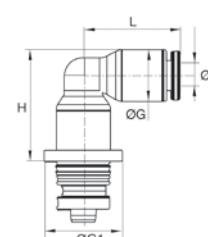

3086 Quick Fitting Reducer

	Nickel-plated brass, NBR 	ØD		Cavity	G	H	kg	
		4	3086 04 06	6	12.5	7	0.005	
		6	3086 06 08	8	14	7.5	0.008	
Available on request								

3089 Quick Fitting Elbow

	Technical polymer, nickel-plated brass, NBR 	ØD		Cavity	G	G1	H	L	kg
		4	3089 04 04	4	9	12.5	11.5	15	0.004
			3089 04 06	6	9	12.5	11.5	15	0.005
		6	3089 06 04	4	11	12.5	14	17	0.004
			3089 06 06	6	11	12.5	12.5	17	0.006
		8	3089 06 08	8	11	14.5	13	17	0.010
			3089 08 08	8	13.5	14.5	16	23	0.011
		10	3089 08 10	10	13.5	19	16	23	0.021
			3089 10 10	10	16	19	19	26.5	0.017
		12	3089 10 12	12	16	20	19	26.5	0.028
			3089 12 12	12	19	20	22	31	0.030

3082 Quick Fitting Extended Elbow

	Technical polymer, nickel-plated brass, NBR 	ØD		Cavity	G	G1	H	L	kg
		4	3082 04 04	4	9	12.5	16	15	0.006
			3082 04 06	6	9	12.5	15	15	0.009
		6	3082 06 06	6	9	12.5	23	19	0.010
			3082 06 08	8	10.5	14	29	18.5	0.014
		8	3082 08 08	8	13.5	17	29.5	22.5	0.021
			3082 08 10	10	13.5	19	29	23	0.025
		10	3082 10 10	10	16	20	33	26	0.029
			3082 10 12	12	16	20	33	26	0.040
		12	3082 12 12	12	19	23	39	31	0.056

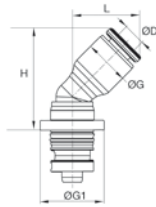
Available on request

Polymer Cartridges for Compressed Air

3081 Quick Fitting 45° Elbow



Technical polymer, nickel-plated brass, NBR



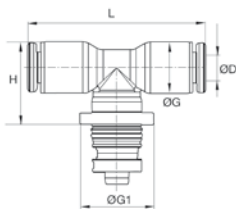
ØD		Cavity	G	G1	H	L	kg
4	3081 04 04	4	9	12.5	19	13	0.004
6	3081 06 06	6	11	12.5	22	14.5	0.006
8	3081 08 08	8	13.5	14.5	26	19	0.011
10	3081 10 10	10	16	19	30	22	0.017
12	3081 12 12	12	19	20	35.5	26	0.031

Available on request

3088 Quick Fitting Tee

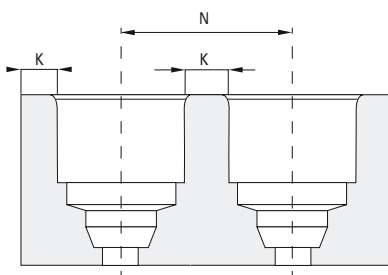
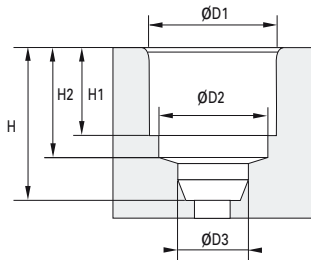


Technical polymer, nickel-plated brass, NBR



ØD		Cavity	G	G1	H	L	kg
4	3088 04 04	4	9	12.5	14	30	0.005
	3088 04 06	6	8.6	12.5	12.5	29.5	0.006
6	3088 06 06	6	11	12.5	14.5	34	0.007
	3088 06 08	8	10.6	14.5	15	33.5	0.011
8	3088 08 08	8	14	14.5	19	46	0.013
	3088 08 10	10	14	19	19	46	0.023
10	3088 10 10	10	16	19	21	53	0.020
	3088 10 12	12	16	20	21	53	0.031
12	3088 12 12	12	19	20	24	61	0.035

Cavity Dimensions



Carstick® et Quick Fitting

Metric

Cavity	ØD3	H	H1	H2
4	4.1	10	6	8.15
6	6.1	12	7.5	9.65
8	8.15	15.5	9.9	12.45
10	10.25	19	11.7	14.35
12	12.17	22	13.9	16.75

Carstick®

Inch

Cavity	ØD3	H	H1	H2
1/8	3.25	7.45	5.3	9.5
5/32*	4.1	8.15	6	10
1/4	6.45	10.15	8	12.5
5/16*	8.15	12.45	9.9	15.5
3/8	9.65	14.35	11.7	19

Polyamide Cavity

Cavity	ØD1	ØD2	N*	N**	K
4	8.25	7.05	9.8	12.3	1.5
6	10.2	9.15	12.2	12.3	2
8	12.15	10.85	14.2	14.3	2
10	14.8	13.2	16.8	19	2
12	17.5	15.5	20	20.2	2.5

Cavity	ØD1	ØD2	N	K
1/8	7.05	6.02	8.6	1.5
5/32*	8.25	7.05	9.75	1.5
1/4	10.55	9.35	12.6	2
5/16*	12.15	10.85	14.2	2
3/8	14.8	13.1	16.8	2

Aluminium Cavity

Cavity	ØD1	ØD2	N*	N**	K*	K**
4	8.25	7.5	11.5	12.3	3	1.5
6	10.3	9.15	13.5	12.3	3	2
8	12.2	10.85	15.2	15.2	3	2
10	15.05	13.2	17.1	19	2	2
12	17.5	15.5	20	20.2	2.5	2.5

Cavity	ØD1	ØD2	N	K
1/8	7.1	6.2	8.6	1.5
5/32*	8.25	7.05	11.25	3
1/4	10.6	9.35	12.65	2
5/16*	12.2	10.85	15.2	3
3/8	15.05	13.1	17.1	2

Brass Cavity

Cavity	ØD1	ØD2	N*	N**	K*	K**
4	8.25	7.05	10.25	12.3	2	1.5
6	10.25	9.1	12.25	12.3	2	2
8	12.2	10.85	14.25	14.3	2	2
10	15.05	13.2	17.1	19	2	2
12	17.65	15.5	20	20.2	2.5	2.5

Cavity	ØD1	ØD2	N	K
1/8	7.1	6.2	8.6	1.5
5/32*	8.25	7.05	10.25	2
1/4	10.6	9.35	12.65	2
5/16*	12.2	10.85	14.25	2
3/8	10.05	13.1	17.1	2

Please consult us for detailed drawings of cavity dimensions and tolerances.


All our dimensions are in millimeters.

*Carstick® / **Quick Fitting

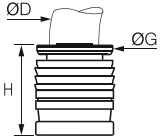
*5/32" = 4 mm and 5/16" = 8 mm

Polymer Cartridges for Fluids and Gases

6300 LIQUIfit® Cartridge




Laiton, EPDM




ØD		G	G1	H	L	kg
4	6300 04 00	8	11	10	554	0.002
6	6300 06 00	10	14.5	11.5	629	0.002
8	6300 08 00	13	15	15	794	0.003
10	6300 10 00	15.5	19.5	17	930	0.005
12	6300 12 00	18.5	21	19.5	1038	0.010

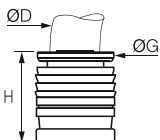
50 cartridges per Carstick®



6300 LIQUIfit® Cartridge




Laiton, EPDM

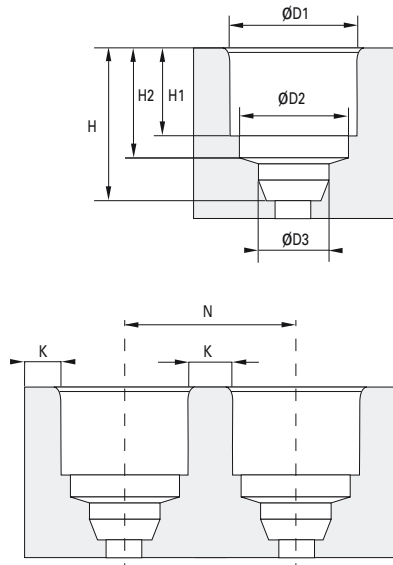


ØD		G	G1	H	L	kg
1/4	6300 56 00	10.5	14.5	12.5	600	0.002
3/8	6300 60 00	15.5	19	17	930	0.005
1/2	6300 62 00	22	25	23	1038	0.011

50 cartridges per Carstick®
5/32" (4 mm) and 5/16" (8 mm) also available



LIQUIfit® Cavity Dimensions



LIQUIfit® Carstick®

Metric

Cavity	ØD3	H	H1	H2
4	4.1	10	6	8.15
6	6.1	12	7.5	9.65
8	8.15	15.5	9.9	12.45
10	10.25	19	11.7	14.35
12	12.17	22	13.9	16.75

LIQUIfit® Carstick®

Inch

Cavity	ØD3	H	H1	H2
1/8	3.25	7.45	5.3	9.5
5/32*	4.1	8.15	6	10
1/4	6.45	10.15	8	12.5
5/16*	8.15	12.45	9.9	15.5
3/8	9.65	14.35	11.7	19

Polyamide Cavity

Cavity	ØD1	ØD2	K	N
4	8.25	7.05	9.8	1.5
6	10.2	9.15	12.2	2
8	12.15	10.85	14.2	2
10	14.8	13.2	16.8	2
12	17.5	15.5	20	2.5

Cavity	ØD1	ØD2	K	N
1/8	7.05	6.02	8.6	1.5
5/32*	8.25	7.05	9.75	1.5
1/4	10.55	9.35	12.6	2
5/16*	12.15	10.85	14.2	2
3/8	14.8	13.1	16.8	2

Aluminium Cavity

Cavity	ØD1	ØD2	K	N
4	8.25	7.5	11.5	3
6	10.3	9.15	13.5	3
8	12.2	10.85	15.2	3
10	15.05	13.2	17.1	2
12	17.5	15.5	20	2.5

Cavity	ØD1	ØD2	K	N
1/8	7.1	6.2	8.6	1.5
5/32*	8.25	7.05	11.25	3
1/4	10.6	9.35	12.65	2
5/16*	12.2	10.85	15.2	3
3/8	15.05	13.1	17.1	2

Brass Cavity

Cavity	ØD1	ØD2	K	N
4	8.25	7.05	10.25	2
6	10.25	9.1	12.25	2
8	12.2	10.85	14.25	2
10	15.05	13.2	17.1	2
12	17.65	15.5	20	2.5

Cavity	ØD1	ØD2	K	N
1/8	7.1	6.2	8.6	1.5
5/32*	8.25	7.05	10.25	2
1/4	10.6	9.35	12.65	2
5/16*	12.2	10.85	14.25	2
3/8	10.05	13.1	17.1	2

*5/32" = 4 mm and 5/16" = 8 mm

Please consult us for detailed drawings of cavity dimensions and tolerances.

All our dimensions are in millimeters.



Metal Cartridges

For full **compatibility** with **many fluids** and severe conditions (**+150°C**), Parker Legris has developed two types of patented cartridges. Using our metal cartridges allows for **optimisation of installation configurations** and for the TL, the possibility of removal.

Product Advantages

- LF Cartridges**
 - LF 3600** All the advantages of the LF 3600, LF 3800 and LF 3900 fittings applied to cartridge technology
 - LF 3800** All-metal product to provide the greatest mechanical strength and chemical resistance
 - LF 3900** Resistant at high temperatures (+150°C)
Can be installed in either polymer or metal housings
- TL Cartridge** Possibility to have several tubing diameters in the same cavity
Visible retention and sealing system, can be disassembled using the dedicated tool



Applications

- Robotics
- Automotive Process
- Pneumatics
- Semi-Conductors
- Refrigeration
- Packaging
- Vacuum

Technical Characteristics

LF Cartridges		TL Cartridge	
Compatible Fluids	Fluids: see corresponding chapters	Compatible Fluids	Compressed air
Working Pressure	Vacuum to 30 bar	Working Pressure	0.01 to 16 bar
Working Temperature	-20°C to +150°C	Working Temperature	-25°C to +80°C
Component Materials	See corresponding chapters	Component Materials	Body: brass Release button: technical polymer Gripping ring: stainless steel Seals: NBR

Regulations


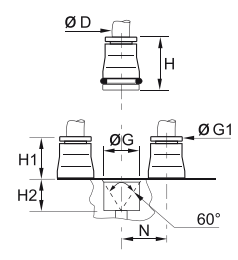

LF 3600, LF 3800, LF 3900
DI: 97/23/CE (PED)
RG: 21 CFR (FDA)
RG: 1935/2004/CE
 (minimum flow 0.02 l/hr)
DI: 2011/65/CE (RoHS)
USDA NSF H1: grease
ASTM B733-04: self-catalytic nickel coating
DI: 94/9/CE (ATEX)

TL
DI: 97/23/CE (PED)
DI: 2011/65/CE (RoHS)


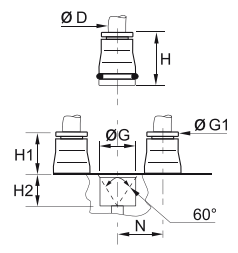


Reliable performance is dependent upon the type of fluid conveyed, component materials and tubing being used. Guaranteed for use with a vacuum of 755 mm Hg (99% vacuum).

Metal Cartridges for Fluids and Gases

3600 One-Piece Cartridge


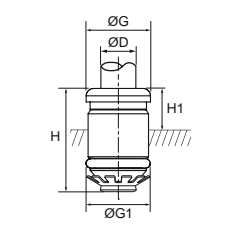

	FDA chemical nickel-plated brass, FKM 	ØD		G	G1	H	H1	H2	N	kg
		4	3600 04 00	9.8	8	17	8.5	8.5	11	0.006
		6	3600 06 00	12.1	10	19	10.5	8.5	13.5	0.009
		8	3600 08 00	14.8	13	21	12.5	8.5	16	0.012
		10	3600 10 00	17.5	15	24.5	14	10.5	20	0.019
		12	3600 12 00	20	17	25	14.5	10.5	22.5	0.023
		14	3600 14 00	22	20	28.5	16.5	12	25	0.031

3800/3900 One-Piece Cartridge

	Stainless steel 316L, FKM 	ØD			G	G1	H	H1	H2	N	kg
		4	3800 04 00	3900 04 00	9.8	8	17	8.5	8.5	11	0.006
		6	3800 06 00	3900 06 00	12.1	10	19	10.5	8.5	13.5	0.008
		8	3800 08 00	3900 08 00	14.8	13	21	12.5	8.5	16	0.012
		10	3800 10 00	3900 10 00	17.5	15	24.5	14	10.5	20	0.019
		12	3800 12 00	3900 12 00	20	17	25	14.5	10.5	22.5	0.023


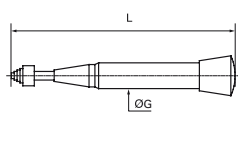

3800: collet in 303 stainless steel
3900: collet in 316L stainless steel

TL Cartridge

	Brass, NBR 	ØD	Cavity		G	G1	H	H1	H1*	kg
		4	4	FTL4	8	8	14.5	4.5	7.5	0.003
		4	6	FTL4-6	8	10	17	4.5	9.5	0.003
		6	6	FTL6	10.5	10	17	4.5	9.5	0.004
		4	8	FTL8-4	8	12	17.5	5	10.5	0.008
		6	8	FTL8-6	10.5	12	18	5.5	11	0.008
		8	8	FTL8	13.5	12	19	6.5	12	0.005

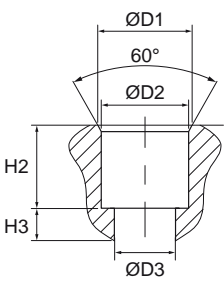
*Can be mounted in a short hole with extremely close porting

TLT Disconnection Tool

			G	L	kg
		TLT	28	156	0.235

Only for use with TL cartridges

Cavity Dimensions

	TL Cartridge					
	Cavity	ØD1	ØD2	ØD3	H2	H3
	4	9	8	5.5	9	1.5
	6	11	10	8	11	1.5
	8	13	12	8.5	11.5	1.5
	4C*	9	8	5.5	6	1.5
	6C*	11	10	8	6	1.5
	8C*	13	12	8.5	6	1.5

*Can be mounted in a short hole with extremely close porting

Customised Solutions

Parker Legris has made **the development of customised products** one of its specialities. These dedicated products provide our customers with a **technical and economic solution** which fully meets their needs.

Customised Solution Development Process

- 1. Define the Function Parameters**

Specify the pressure, temperature, environment, fluids, materials and product function you need.

Estimate the quantity requirements.

Our product engineers are available to help you refine your requirements.
- 2. Send Your Request to our Technical Department**

Complete the online request form at www.parkerlegris.com, "Special Products".

Specify your quantities, technical and commercial requirements.
- 3. Request Analysis**

We assess the feasibility of the product based on the information you have sent us.

We carry out a technical study and produce drawings (prototypes and testing as necessary).
- 4. Parker Legris Proposes the Customised Solution**

We submit the optimum technical and commercial proposal.

If our proposal is accepted, we launch the production process.
- 5. Serial Production**

We will continually update you as to the status of your order and delivery date.

Customised Products

Cartridges



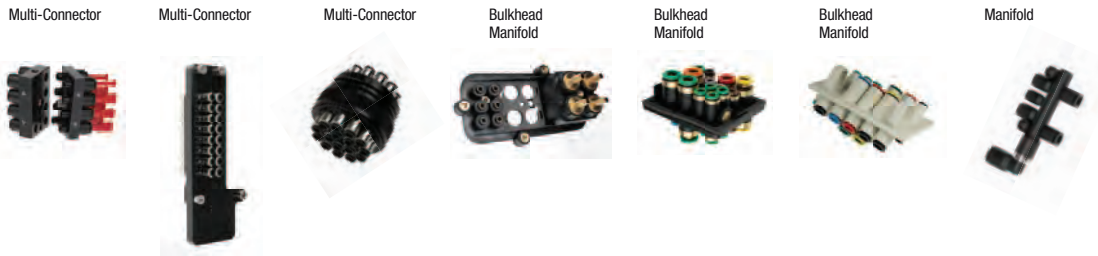
Fittings



Function Fittings



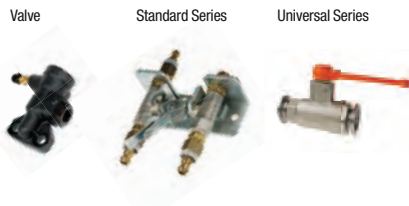
Multi-Connectors and Manifolds



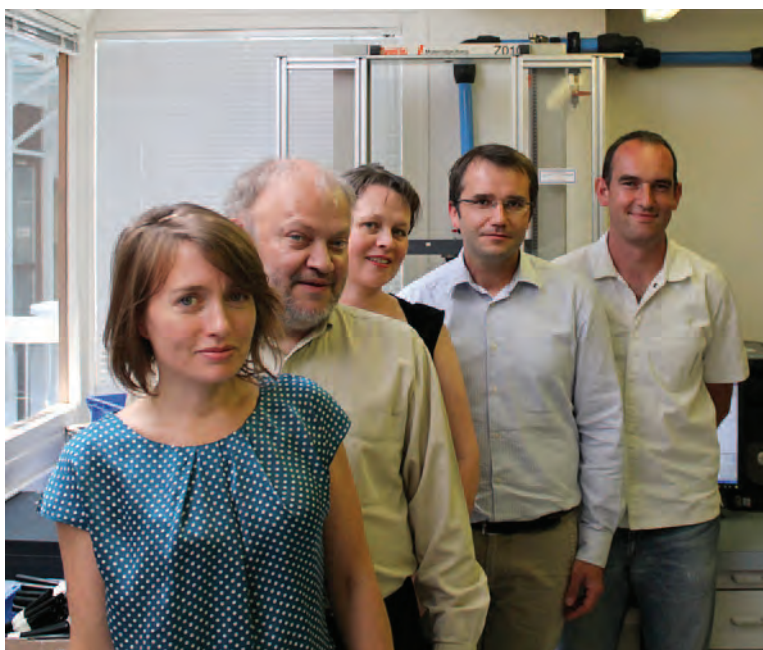
Tubing and Blowguns



Valves



Skilled and Dedicated People Provide You with the Best Solution



More than 40 years' experience in the design of push-in fittings also means more than 40 years spent in producing customised solutions for our customers.

We have a team of motivated and experienced engineers skilled in using the latest design tools: calculation and digital simulation tools, CAD, rheology (plastic injection modelling), quick prototyping and performance measuring in the laboratory.

Customised Fittings

To meet your needs, we can re-engineer the design of our fittings.

To complement our wide range of fittings, we can offer customised products.

Longer threads, different types of seal, special grease, specific cleaning processes, colours, packaging, etc. are all parameters which we can easily modify.



Low Temperature Carstick®

Resistant at -40°C



Metal Cartridges

Cartridges adapted to the client's dimensional and environmental requirements

Combination of the patented Carstick® system (seal protection) and LF 3600 performance levels



Fitting for Breathable Air

Specific gripping feature, cleanliness, oxygen-compatible grease

Reinforced leak testing

Coloured release button for fluid identification

Special packaging



Fitting for the Transmission of Deionised Cooling Water in Frequency Inverters

Water-resistant materials

Stainless steel threads

Special seals



Fitting for the Transmission of Water in Ceiling-Mounted Air Conditioning Systems

Brass body

Double seal

Crimped to hose



Orifice Fitting

Allows accurate flow regulation

Minimum orifice diameter: 0.5 mm



Non-Return Valve

Developed for systems carrying breathable air
Low cracking threshold
Oxygen-compatible grease, cleanliness



Compact Flow Regulator with Recessed Screw and FKM Seals

Improved external chemical resistance
Custom logo



Multi-Connector

Allows disconnection of up to 16 tubes in a single operation
Compact design suitable for the operating environment



Polymer Body with Integrated Fittings

For connection of pneumatic lines between the truck cab and chassis



Polymer Manifold

Reinforced integrated connections
Dedicated to the distribution of compressed air for truck auxiliary systems e.g. cab seat, air horn, gauges...

Customised Tubing and Blowguns

We can adapt the formulation of polymers and customise tubing or blowguns to suit your requirements.

We can offer custom modifications such as: special additives and materials, non-standard diameters, customised marking, specific packaging, custom colours, custom tube cutting, pre-formed tubing, packaged solutions (tubes + fittings or couplers, blowgun kits).



Tube marked with customer's name
Tubes cut to specific lengths



Marked with the customer's logo and part number
In lengths of 5 m, 10 m, 25 m, 50 m and 100 m, depending on the tube material
For flexible or semi-rigid tubing
Optimised tube packaging
Easy identification of the tube type
Integrated reel for easy handling



Marked with the customer's logo and part number
Up to 1000 m lengths
Immediate identification of the tube for easy handling
Suitable for workshop hose reels



Blowgun customised in customer's colours
Specific logo
Customised packaging



Production of a "tube + coupler + blowgun" assembly in dedicated and customised packaging

Customised Valves

Over and above our range of standard valves, Parker Legris can supply application-specific valves adapted to our customers' environment.

We offer custom modifications such as: longer threads, different types of seal, special grease, lever options, specific cleaning process, materials and surface treatments, assemblies, etc.



Transport Valve

Mounted on the wheel rims of armoured vehicles
For managing tyre pressures through an integrated inflation valve



Auto-Process Valve

Designed to simultaneously control both the inlet and outlet of a cooling line
Also allows one of the lines to be closed independently



Valve for Breathable Air

Dedicated to the transmission of oxygen-enriched air in hospital networks
Special seals, cleanliness, specific grease, very high reliability

Technical Tubing and Hose

Flexible Calibrated Tubing

Calibrated Multi-Tubing

Recoil Tubing and Hose

Calibrated Braided Hose

Accessories



PARKER LEGRIS Industrial Connector Systems

Products are available from:

MARYLAND METRICS

P.O. Box 261 Owings Mills, MD 21117 USA email: sales@mdmetric.com

ph: (410)358-3130 (800)638-1830 fx: (410)358-3142 (800)872-9329

web: <http://mdmetric.com> RFQ form: <http://mdmetric.com/rfq.htm>

How to order: Please preface each PARKER LEGRIS Catalog part number with 'R053-' Example: R053-3175 04 10



Technical Tubing and Hose

PA Tubing (P. 3-10)



Fluids: Compressed air, industrial fluids

Materials:

- 2 polyamide grades (semi-rigid and rigid)
- 7 colours

Pressure: 58 bar

Temperature: -40°C to +100°C

O.D. metric: 3 mm to 16 mm

O.D. inch: on request

Fireproof High Resistance PA Tubing (P. 3-14)



Fluids: compressed air, coolants, lubricants

Materials:

- Polyamide with flame retardant additive
- 5 colours

Pressure: 50 bar

Temperature: -40°C to +100°C

O.D. metric: 4 mm to 12 mm

Anti-Spark PA or PU Tubing, with or without PVC Sheath (P. 3-16 & 24)



Fluids : compressed air, coolants, industrial fluids

Materials :

- Semi-rigid polyamide with PVC sheath
- Polyurethane ether with PVC sheath
- Single layer polyurethane ether
- 4 colours

Pressure: 36 bar max.

Temperature: -20°C to +80°C

O.D. metric: 4 mm to 12 mm

PU Tubing (P. 3-18)



Fluids: compressed air and food industry fluids ("crystal")

Materials:

- Polyurethane ester or ether
- Polyurethane food-grade "crystal"
- 7 colours

Pressure: 12 bar

Temperature: -20°C to +70°C

O.D. metric: 3 mm to 16 mm

O.D. inch: on request

Antistatic PU Tubing (P. 3-22)



Fluids: compressed air

Materials:

- Polyurethane with conductive particles
- Black (10² Ω.m)

Pressure: 10 bar

Temperature: -20°C to +70°C

O.D. metric: 3 mm to 12 mm

PE Tubing (P. 3-26)



Fluids: many fluids

Materials:

- Low density polyethylene
- 50% reticulated polyethylene, food-grade
- 7 colours

Pressure: 20 bar

Temperature: -40°C to +95°C

O.D. metric: 4 mm to 14 mm

O.D. inch: 1/8" to 1/2"

FEP Tubing (P. 3-28)



Fluids: many fluids

Materials:

- Fluoropolymer: fluorinated ethylene propylene, food-grade
- Transparent

Pressure: 28 bar

Temperature: -40°C to +150°C

O.D. metric: 4 mm to 12 mm

PFA Tubing (P. 3-30)



Fluids: many fluids

Materials:

- 3 grades of perfluoroalkoxy
- High purity food-grade, clear
- Standard food-grade, 3 "crystal" colours
- Antistatic (0.2 Ω.m), black

Pressure: 36 bar

Temperature: -196°C to +260°C

O.D. metric: 4 mm to 12 mm

PA Multi-Tubing (P. 3-32)



Fluids: compressed air, industrial fluids

Materials:

- Semi-rigid polyamide with PVC sheath
- 6 colours

Pressure: 24 bar

Temperature: -40°C to +80°C

O.D. metric: 4 mm to 8 mm

Technical Tubing and Hose

Twin PU Tubing

(P. 3-32)



Fluids: compressed air

Materials:

- Polyurethane ester
- 1 to 2 colours

Pressure: 14 bar

Temperature: -20°C to +70°C

O.D. metric: 4 mm to 8 mm

Recoil PA Tubing

(P. 3-34)



Fluids: compressed air, industrial fluids

Materials:

- Semi-rigid polyamide
- 2 colours
- Recoil tubing with fittings

Pressure: 20 bar

Temperature: -20°C to +80°C

O.D. metric: 6 mm and 8 mm

Recoil PU Tubing

(P. 3-36)



Fluids: compressed air

Materials:

- Polyurethane ester or ether
- 3 colours
- With or without fittings

Pressure: 10 bar

Temperature: -20°C to +70°C

O.D. metric: 4 mm to 12 mm

I.D. inch: 3/8" and 19/32"

Braided PU Recoil Hose

(P. 3-40)



Fluids: compressed air, industrial fluids

Materials:

- Translucent blue polyurethane, reinforced with a polyester braid
- Assembled with threaded fittings

Pressure: 15 bar

Temperature: -40°C to +75°C

I.D. inch: 1/4" and 5/16"

Braided PVC Hose

(P. 3-42)



Fluids: compressed air, non-corrosive or alimentary fluids (translucent PVC)

Materials:

- Polyvinyl chloride with braided polyester
- Translucent (food-grade) or blue (industrial)

Pressure: 15 bar

Temperature: -25°C to +70°C

I.D. metric: 4 mm to 19 mm

Self-Fastening NBR Hose

(P. 3-44)



Fluids: compressed air, coolants

Materials:

- Nitrile butadiene rubber reinforced with a polyamide braid
- 4 colours

Pressure: 16 bar

Temperature: -20°C to +100°C

I.D. inch: 1/4" to 3/4"

Technical Tubing and Hose Range

Flexible Calibrated Tubing

Polyamide Tubing

Semi-Rigid PA



1025P
1100P
2005P
2010P
Page 3-11

Rigid PA



1025L
Page 3-12

Fireproof PA



1025P..R
1100P..R
2005P..R
2010P..R
Page 3-15

Anti-Spark PA with PVC Sheath



1025P..V
1100P..V
Page 3-17

Polyurethane Tubing

PU Ester



1025U
1100U
2003U
2005U
2010U
Page 3-19

PU Ether PU Ether Food-Grade "Crystal"



1025U..R
1100U..R
2003U..R
2005U..R
2010U..R
Page 3-20

Antistatic PU



1025U..A
1100U..A
Page 3-23

PU Ether, Anti-Spark, Single Layer PU Ether, Anti-Spark with PVC Sheath



1025U..V
1100U..V
Page 3-25
1025U..K
1100U..K
Page 3-25

Polyethylene Tubing

Advanced PE



1015Y..F
1030Y..F
1075Y..F
1096Y..F
1098Y..F
1099Y..F
Page 3-27

Low Density PE



1025Y
1100Y
Page 3-27

Fluoropolymer Tubing

FEP



1005T
1025T
Page 3-29

PFA



1010T..P
1050T..P
1100T..P
Page 3-31

Antistatic PFA



1010T..A
1050T..A
Page 3-31

Calibrated Multi-Tubing

Polyamide Tubing with PVC Sheath

Semi-Rigid PA



1010P..M
1050P..M
Page 3-33

Twin Polyurethane Tubing

Twin PU Ester



1420U
Page 3-33

Technical Tubing and Hose Range

Calibrated Recoil Tubing

Semi-Rigid PA

Assembled with Fittings



1470P
1471P
1472P
Page 3-35

PU Ester and Ether Tubing

Assembled with Fittings,
Metallic Spring Guard



1470U
1471U
1472U
Page 3-37

Assembled with Fittings,
Plastic Spring Guard



1445U..R
1441U..R
1442U..R
1447U..R
Page 3-38

Coiled without Fittings



1460U
1461U
1462U
Page 3-37

Braided PU Hose

Assembled with Fittings,
Plastic Spring Guard



1445U..E
1442U..E
1447U..E
Page 3-41

Calibrated Braided Hose

Clear Food-Grade PVC



1025V
1050V
Page 3-43

Blue PVC



1025V..C
1050V..C
Page 3-43

Self-Fastening NBR



1040H
1080H
1100H
Page 3-45

Accessories

0694
Page 3-46



0695
Page 3-46



3000 71 11
Page 3-46



3000 71
Page 3-46



6000 71
Page 3-46



0127
Page 3-47



1827
Page 3-47



Clip
Page 3-47



0697
Page 3-47



Packaging for Technical Tubing and Hose

Tubepack®

- 5 m, 10 m, 25 m and 100 m lengths
- For polyamide, polyurethane, fluoropolymer, polyethylene and anti-spark tubing
- Optimisation of tubing storage
- Immediate identification of the type of tubing
- Integrated winder for easy handling



Drums

- Up to 1000 m long
- For polyamide, polyurethane, fluoropolymer tubing, etc.
- Immediate identification of the tubing for easy handling
- Adapted to workshop reels



Reels

- Up to 100 m
- Supplied with protective plastic film
- For braided tubing, special tubing (e.g. multi-tubing)



Plastic Bags

- Ideal for merchandising
- Promotional tools
- Recoil tubing or tubing cut to the required length



Tube Marking (except for Fluoropolymer, PFA and FEP)

- Length indicated every metre:
 - time saved when cutting to exact length
 - remaining quantity is immediately identifiable (PA and PU)
- Custom marking upon request (marking, fluid identification, customer part number...)
- Traceability with marking of manufacturing batch



Tube Cutting to the Required Length

- Upon request, cutting of your tube to the required length, from 5 cm to 3 m
- Precision +/- 3 mm
- Ideal for optimising your installation costs



Product Codes of Parker Legris Tubing and Hose

Material

- H** = Self-Fastening NBR
- L** = Rigid Polyamide
- P** = Semi-Rigid Polyamide
- T** = Fluoropolymer
- U** = Polyurethane
- V** = PVC
- Y** = Polyethylene

Type of Tubing

- P..A** = Antistatic PA
- P..R** = Fireproof PA
- P..V** = Anti-Spark PA with PVC Sheath
- T..A** = Antistatic PFA
- T..P** = PFA
- U..A** = Antistatic PU
- U..K** = Anti-Spark Single Layer PU
- U..R** = PU Ether
- U..V** = Anti-Spark PU with PVC Sheath
- Y..F** = Advanced PE (LIQUIfit™)

2 010 P 04 R 00 27

Packaging Code

1 = Tubepack® or LIQUIfit® Drum

Length

015 = 150 m
020 = 20 m
025 = 25 m
030 = 300 m
040 = 40 m
075 = 75 m
080 = 80 m
100 = 100 m

O.D. Code

03 = 3 mm
04 = 4 mm
06 = 6 mm
08 = 8 mm
 .../...
 1/4 = 56 mm
 .../...

Colour

00 = clear
01 = black
02 = green
03 = red
04 = blue
05 = yellow
06 = grey
07 = orange
08 = crystal clear
09 = purple
10 = white
12 = crystal green
13 = crystal red
14 = crystal blue
17 = crystal orange

Special I.D.

18 = 1.8 mm
27 = 2.7 mm
33 = 3.3 mm
75 = 7.5 mm
95 = 9.5 mm

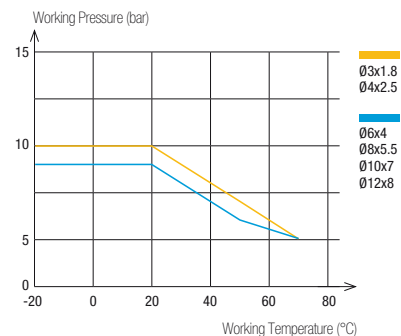
2 = Long Length on Drum

003 = 300 m
005 = 500 m
010 = 1000 m

10 = 10 mm
04 = 4 mm
06 = 6 mm
08 = 8 mm
10 = 10 mm
04 = 4 mm
06 = 6 mm

How to Read the Graphs

- In the graphs in this chapter, each curve represents the acceptable maximum pressure at a given temperature, by diameter.
- Technical characteristics of Parker Legris tubing depend on the type of connection used.
- The vacuum capability of all tubing is 755 mm Hg (99% vacuum).



PA Tubing

Tried-and-tested for industrial or vehicle applications, PA tubing guarantees **excellent durability** due to its stable long-term mechanical properties.

Parker Legris' special grade of semi-rigid polyamide is manufactured according to our **Eco-Design** approach for higher performance.

Product Advantages

Tried-&-Tested Material

- Good chemical and humidity resistance
- Excellent material stability (mechanical and chemical)
- Continuous calibration during production for excellent reliability
- Two material grades: rigid and semi-rigid
- Bio-based semi-rigid material

Versatility & Performance

- Wide range of working pressure and temperature
- Good vibration absorption
- Abrasion-resistant
- Remaining length marking
- Large choice of colours to facilitate circuit identification
- Silicone-free



Applications

- Packaging
- Tooling
- Compressed Air
- Motion Technologies
- Robotics
- Industrial Machinery

Technical Characteristics

Tubing	Semi-Rigid PA	Rigid PA
Compatible Fluids	Compressed air, other fluids	Compressed air, lubricants, other fluids
Working Pressure	Vacuum to 50 bar	Vacuum to 60 bar
Working Temperature	-40°C to +100°C	-40°C to +80°C
Component Materials	Bio-based polyamide (68 shore D)	Polyamide (65 shore D)

Regulations

Industrial

- DI: 2002/95/EC (RoHS), 2011/65/EC
- DI: 97/23/EC (PED)
- RG: 1907/2006 (REACH)

Transportation

Chemical performance and resistance tested according to DIN 74324 -1 / DIN 73378 / ISO 7628

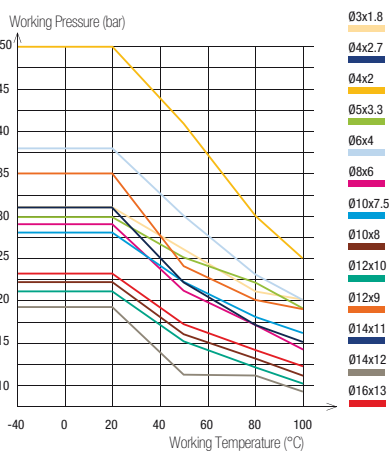
Packaging

- Tube pack*: 25 m, 100 m
- Drum: 500 m, 1 000 m

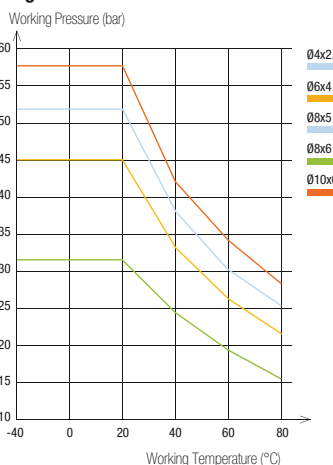
Reliable performance is dependent upon the type of fluid conveyed and fittings being used. Use is guaranteed with a vacuum of 755 mm Hg (99% vacuum).

Performance of PA Tubing

Semi-Rigid



Rigid



Tube O.D.	Tube O.D. Tolerance
3 to 5 mm	+0.05 / -0.08
6 to 16 mm	+0.05 / -0.10

Connected to Parker Legris push-in fittings, the calibration of Parker Legris tubing ensures perfect sealing in accordance with NF E49-100.

1025P Semi-Rigid Polyamide (PA) Tubing

Tubepack® 25 m

O.D. (mm)	I.D. (mm)	R	Clear							kg
3	1.8	6	1025P03 00 18					1025P03 04 18		0.020
4	2	10	1025P04 00	1025P04 01	1025P04 02	1025P04 03	1025P04 04	1025P04 05	1025P04 06	0.318
4	2.7	10	1025P04 00 27	1025P04 01 27	1025P04 02 27	1025P04 03 27	1025P04 04 27	1025P04 05 27	1025P04 06 27	0.254
5	3.3	15	1025P05 00 33	1025P05 01 33			1025P05 04 33			0.420
6	4	15	1025P06 00	1025P06 01	1025P06 02	1025P06 03	1025P06 04	1025P06 05	1025P06 06	0.535
8	6	25	1025P08 00	1025P08 01	1025P08 02	1025P08 03	1025P08 04	1025P08 05	1025P08 06	0.748
10	7.5	42	1025P10 00 75	1025P10 01 75			1025P10 04 75			1.135
10	8	50	1025P10 00	1025P10 01	1025P10 02	1025P10 03	1025P10 04	1025P10 05	1025P10 06	0.989
12	9	47	1025P12 00 09	1025P12 01 09			1025P12 04 09			1.769
12	10	90	1025P12 00	1025P12 01			1025P12 04			1.345
14	11	80	1025P14 00 11	1025P14 01 11			1025P14 04 11			2.226
14	12	116	1025P14 00	1025P14 01			1025P14 04			1.734
16	13	90	1025P16 00 13	1025P16 01 13	1025P16 02 13	1025P16 03 13	1025P16 04 13			2.500

Inch version tubing available upon request

1100P Semi-Rigid Polyamide (PA) Tubing

Tubepack® 100 m

O.D. (mm)	I.D. (mm)	R	Clear							kg
4	2	10	1100P04 00	1100P04 01	1100P04 02	1100P04 03	1100P04 04	1100P04 05	1100P04 06	1.152
4	2.7	10	1100P04 00 27	1100P04 01 27	1100P04 02 27	1100P04 03 27	1100P04 04 27	1100P04 05 27	1100P04 06 27	0.893
5	3.3	15	1100P05 00 33	1100P05 01 33			1100P05 04 33			1.274
6	4	15	1100P06 00	1100P06 01	1100P06 02	1100P06 03	1100P06 04	1100P06 05	1100P06 06	1.799
8	6	25	1100P08 00	1100P08 01	1100P08 02	1100P08 03	1100P08 04	1100P08 05	1100P08 06	2.898
10	7.5	42	1100P10 00 75	1100P10 01 75			1100P10 04 75			4.400
10	8	50	1100P10 00	1100P10 01	1100P10 02	1100P10 03	1100P10 04	1100P10 05		3.667
12	9	47	1100P12 00 09	1100P12 01 09			1100P12 04 09			5.600
12	10	90	1100P12 00	1100P12 01			1100P12 04		1100P12 06	5.052
14	11	80	1100P14 00 11	1100P14 01 11			1100P14 04 11			5.200
14	12	116	1100P14 00	1100P14 01			1100P14 04			4.800
16	13	90	1100P16 00 13	1100P16 01 13	1100P16 02 13	1100P16 03 13	1100P16 04 13			7.800

Inch version tubing available upon request

2005P Semi-Rigid Polyamide (PA) Tubing

Drum 500 m

O.D. (mm)	I.D. (mm)	R	Clear							kg
8	6	25	2005P08 00	2005P08 01	2005P08 02	2005P08 03	2005P08 04	2005P08 05	2005P08 06	12.100
10	8	50	2005P10 00	2005P10 01	2005P10 02	2005P10 03	2005P10 04	2005P10 05		15.600

2010P Semi-Rigid Polyamide (PA) Tubing

Drum 1000 m

O.D. (mm)	I.D. (mm)	R	Clear							kg
4	2.7	10	2010P04 00 27	2010P04 01 27	2010P04 02 27	2010P04 03 27	2010P04 04 27	2010P04 05 27	2010P04 06 27	7.630
6	4	15	2010P06 00	2010P06 01	2010P06 02	2010P06 03	2010P06 04	2010P06 05	2010P06 06	16.600

Tube Cutting to the Required Length



- Cutting of your tubing upon request, from 5 cm to 3 m
- Precision +/- 3 mm
- Ideal for optimising your installation costs



PA Tubing

1025L Rigid Polyamide (PA) Tubing

Tubepack® 25 m

O.D. (mm)	I.D. (mm)	 R		kg
4	2.5	35	1025L04 01 25	0.190
6	4	45	1025L06 01	0.400
8	5	70	1025L08 01 05	0.760
8	6	65	1025L08 01	0.760
10	6	85	1025L10 01 06	1.330

PA tubing can be connected to various fittings shown throughout this catalogue.

Tubing

Semi-Rigid PA



Rigid PA



Push-In Fittings

LF 3000® P. 1-4



LF 3600 P. 1-65



LF 3800/LF 3900 P. 1-77



LF 6100 P. 1-89



Compression Fittings

Brass P. 5-5



Stainless Steel P. 5-31



Ferrules P. 5-5





Flexible Calibrated Tubing

Technical Tubing & Hose

Fireproof High Resistance PA Tubing

This **single layer fireproof** tubing not only combines excellent resistance to pressure, temperature and flame, but also guarantees **non-toxic smoke** resulting from burn-off. This tubing eliminates the need for a stripping tool, thus preventing the risk of tube damage prior to connection.

Product Advantages

Safety for On-Board Railway Equipment

- Designed for on-board equipment
- Excellent flame-resistance: self-extinguishing
- Very little smoke generation
- Non-toxic combustion gases
- UV-resistant
- Extremely resistant to high pressure and temperature

Innovative Single-Layer Solution

- Developed for demanding industrial applications
- Excellent spark resistance
- Economical alternative to PA tubing with PVC sheath
- Combines technical advantages of rigid and semi-rigid PA tubing
- 5 colours available
- Flow direction marking
- Silicone-free



- Applications**
- Railway
 - Air Horns
 - Industrial Machinery
 - Pneumatic Doors
 - Step-Units
 - Centralised Lubrication
 - Welding

Technical Characteristics

Compatible Fluids	Compressed air, lubricants Other fluids: please consult us
Working Pressure	Vacuum to 50 bar
Working Temperature	-40°C to +100°C
Component Materials	Polyamide (63 shore D)

Regulations

Railway

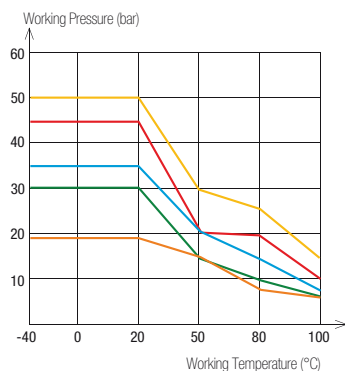
Pr EN 45545-2: HL3, R22, R24, R25
NF F16101: I3 F2,
DIN 5510-2: S4, SR2, ST2
ISO 4892

Industrial

DI: 97/23/EC (PED)
DI: 2002/95/EC (RoHS), 2011/65/EC
RG: 1907/2006/EC (REACH)
UL94 V-0 (Fire resistance)

Reliable performance is dependent upon the type of fluid conveyed and fittings being used. Use is guaranteed with a vacuum of 755 mm Hg (99% vacuum).

Performance of Fireproof High Resistance PA Tubing



Tube O.D.	Tube O.D. Tolerance
4 mm	+0.05 / -0.08
6 to 12 mm	+0.05 / -0.10

Packaging







Tube pack: 25 m, 100 m
Drum: 500 m, 1000 m

Connected to Parker Legris push-in fittings, the calibration of PA tubing ensures perfect sealing based on NF E49-100.

To calculate burst pressure, the values in this graph should be multiplied by 3.







1025P..R Fireproof High Resistant Polyamide (PA)

Tubepack® 25 m

O.D. (mm)	I.D. (mm)		 Clear					kg
4	2	17	1025P04R00	1025P04R01	1025P04R02	1025P04R03	1025P04R04	0.367
6	4	29	1025P06R00	1025P06R01	1025P06R02	1025P06R03	1025P06R04	0.554
8	6	40	1025P08R00	1025P08R01	1025P08R02	1025P08R03	1025P08R04	0.554
10	8	77	1025P10R00	1025P10R01	1025P10R02	1025P10R03	1025P10R04	0.721
12	9	92	1025P12R00	1025P12R01	1025P12R02		1025P12R04	1.345







1100P..R Fireproof High Resistant Polyamide (PA)

Tubepack® 100 m

O.D. (mm)	I.D. (mm)		 Clear					kg
4	2	17	1100P04R00	1100P04R01	1100P04R02	1100P04R03	1100P04R04	1.308
6	4	29	1100P06R00	1100P06R01	1100P06R02	1100P06R03	1100P06R04	1.308
8	6	40	1100P08R00	1100P08R01	1100P08R02	1100P08R03	1100P08R04	2.122
10	8	77	1100P10R00	1100P10R01	1100P10R02	1100P10R03	1100P10R04	2.725
12	9	92	1100P12R00	1100P12R01			1100P12R04	5.052







2005P..R Fireproof High Resistant Polyamide (PA)

Drum 500 m

O.D. (mm)	I.D. (mm)		 Clear					kg
8	6	40	2005P08R00	2005P08R01	2005P08R02	2005P08R03	2005P08R04	17.500
10	8	77	2005P10R00	2005P10R01	2005P10R02	2005P10R03	2005P10R04	22.800

2010P..R Fireproof High Resistant Polyamide (PA)

Drum 1000 m

O.D. (mm)	I.D. (mm)		 Clear					kg
4	2	17	2010P04R00	2010P04R01	2010P04R02	2010P04R03	2010P04R04	14.300
6	4	29	2010P06R00	2010P06R01	2010P06R02	2010P06R03	2010P06R04	23.000

Related Products

Fireproof high resistance tubing can be connected to various fittings presented in this catalogue in Chapter 1.

Push-In Fittings

- LF 3000*** P. 1-4
- LF 3600** P. 1-65
- LF 3800/LF 3900** P. 1-77
- LF 6100** P. 1-89



Compression Fittings

- Brass** P. 5-5
- Brass Tube Support** P. 5-5



Anti-Spark PA Tubing with PVC Sheath

A range of **flame and spark-resistant** PA tubing with superior resistance to impact and abrasion, improving equipment **durability**, particularly in areas subject to weld spatter.

Product Advantages

Spark Resistance | Flame-retardant PVC jacket protects inner tubing
 Non-adhesive jacket facilitates sheath removal
 Excellent pressure resistance at high temperature

Robustness & Durability | Highly kink and crush-resistant
 Excellent compatibility with coolants
 Flow direction marking
 Silicone-free



Industrial Machinery
 Welding Robots
 Cooling
 Aggressive Environments

Applications

Technical Characteristics

Compatible Fluids	Hot and cold water, refrigerated fluids, compressed air
Working Pressure	0 to 36 bar
Working Temperature	-20°C to +80°C
Component Materials	Polyamide & PVC Sheath

Regulations

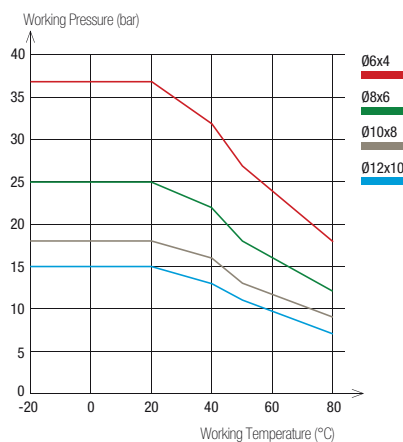
Industrial
 DI: 2002/95/EC (RoHS), 2011/65/EC
 DI: 97/23/EC (PED)
 RG: 1907/2006 (REACH)
 UL94 V-0 (Fire resistance)

Packaging

Tube pack*: 25 m, 100 m

Reliable performance is dependent upon the type of fluid conveyed and fittings being used.

Performance of Anti-Spark PA Tubing with PVC Sheath



O.D.	Tube O.D. Tolerance	PVC Sheath Thickness
PVC Sheath 8 to 14 mm	+0.10 / -0.10	1 mm
Inner Tubing 6 to 12 mm	+0.05 / -0.10	

Connected to Parker Legris push-in fittings, the calibration of PA tubing ensures perfect sealing based on NF E49-100 (semi-rigid PA inner tubing).





Tube O.D.	Sheath Removal Length for LF 3600 Push-In Fittings (mm)
4 mm	15± 1
6 mm	18± 1
8 mm	19± 1
10 mm	24± 1
12 mm	25± 1

For other fitting ranges, please consult us.

To calculate burst pressure, the values in this graph should be multiplied by 3.





1025P..V Anti-Spark Polyamide (PA) Tubing

Tubepack® 25 m



O.D. (mm)	I.D. (mm)	R					kg
6	4	25	1025P06V01	1025P06V02	1025P06V03	1025P06V04	1.238
8	6	30	1025P08V01	1025P08V02	1025P08V03	1025P08V04	1.693
10	8	55	1025P10V01	1025P10V02	1025P10V03	1025P10V04	2.029
12	10	70	1025P12V01	1025P12V02	1025P12V03	1025P12V04	2.970

1100P..V Anti-Spark Polyamide (PA) Tubing

Tubepack® 100 m

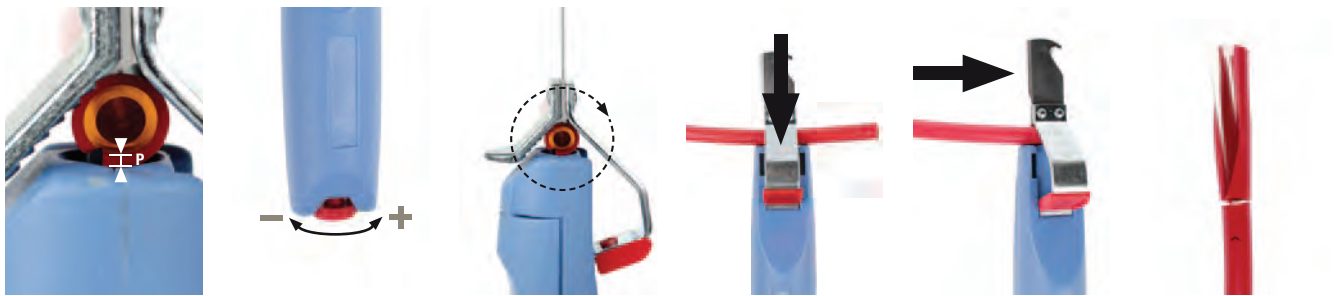
O.D. (mm)	I.D. (mm)	R					kg
6	4	25	1100P06V01	1100P06V02	1100P06V03	1100P06V04	2.338
8	6	30	1100P08V01	1100P08V02	1100P08V03	1100P08V04	3.767
10	8	55	1100P10V01	1100P10V02	1100P10V03	1100P10V04	4.767
12	10	70	1100P12V01	1100P12V02	1100P12V03	1100P12V04	6.567

6000 71 00 Stripping Tool for Anti-Spark Tubing

	Technical polymer, stainless steel		kg
		6000 71 00	0.098

Working Principle

Stripping Tool 6000 71 00



1. Place tube in stripping tool to adjust the blade height to the tube thickness.

2. Blade height is adjusted using the wheel at the bottom of the handle.

3. Once adjustments have been made, perform a 360° rotation around the tube with the tool.

4. Push down firmly on the metal part of the tool in order to hold tube properly.

5. Move the tool to the end of the tube to create an axial opening of the sheath.

6. The tube is correctly stripped.

PU Tubing

Polyurethane's **3 specific materials** - ether, ester and food-grade "crystal" - offer excellent flexibility and outstanding use in a wide range of applications, allowing for up to **50% space reduction** when compared to semi-rigid PA tubing.

Product Advantages

Excellent Mechanical Properties

- Consistent tensile strength for optimum longevity
- Optimal bend radius
- Good vibration absorption
- Unsurpassed abrasion resistance for a single layer tubing
- UV-resistant
- Superior vacuum capability due to surface hardness
- Remaining length marking
- Silicone-free

3 Material Grades

- PU ester: perfect for pneumatic applications
- PU ether: no water absorption ; superior chemical resistance to PU ester
- PU ether food-grade "crystal":
 - identification of fluids and circuits
 - chemical resistance superior to PU ether
 - improved longevity



- ### Applications
- Food Process
 - Robotics
 - Cabling
 - Pneumatics
 - Automation
 - In-Plant Automotive
 - Rapid Cycles

Technical Characteristics

Compatible Fluids	Compressed air, industrial fluids (depending on the material type)
Working Pressure	Vacuum to 12 bar
Working Temperature	-20°C to +70°C
Component Materials	Polyurethane ester Polyurethane ether Polyurethane ether food-grade "crystal"

Regulations

Industrial

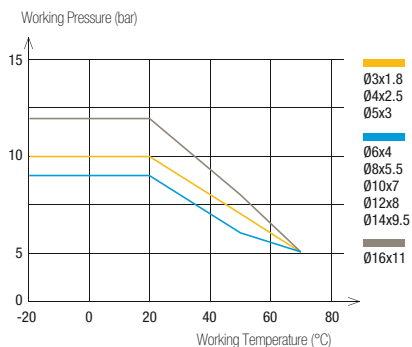
- DI: 2002/95/EC (RoHS), 2011/65/EC
- DI: 97/23/EC (PED)
- RG: 1907/2006 (REACH)

Food (PU ether food-grade "crystal")

- FDA: 21 CFR 177.2600, 178.3297, 176.170, 178.2010
- RG: 1935/2004 EC

Reliable performance is dependent upon the type of fluid conveyed and fittings being used. Use is guaranteed with a vacuum of 755 mm Hg (99% vacuum).

Performance of PU Tubing



Tube O.D.	Tube O.D. Tolerance
3 to 8 mm	+0.10 / -0.10
10 to 16 mm	+0.15 / -0.15

Packaging








- Tube pack*: 25 m, 100 m
- Drum: 300 m, 500 m, 1000 m

Connected to Parker Legris push-in fittings, the calibration of PU tubing ensures perfect sealing based on NF E49-101.

To calculate burst pressure, the values in this graph should be multiplied by 3.

1025U Polyurethane (PU) Ester Tubing








Tubepack® 25 m

O.D. (mm)	I.D. (mm)								kg
3	1.8	8	1025U03 01 18						0.020
4	2.5	10	1025U04 01	1025U04 02	1025U04 03	1025U04 04	1025U04 05	1025U04 06	0.310
5	3	13	1025U05 01			1025U05 04			0.522
6	4	15	1025U06 01	1025U06 02	1025U06 03	1025U06 04	1025U06 05	1025U06 06	0.591
8	5.5	20	1025U08 01	1025U08 02	1025U08 03	1025U08 04	1025U08 05	1025U08 06	0.971
10	7	25	1025U10 01	1025U10 02		1025U10 04	1025U10 05	1025U10 06	1.467
12	8	35	1025U12 01	1025U12 02		1025U12 04	1025U12 05	1025U12 06	2.406
14	9.5	45	1025U14 01 95			1025U14 04 95			2.815
16	11	45	1025U16 01 11	1025U16 02 11	1025U16 03 11	1025U16 04 11			2.815

Inch tubing available upon request

1100U Polyurethane (PU) Ester Tubing








Tubepack® 100 m

O.D. (mm)	I.D. (mm)								kg
4	2.5	10	1100U04 01	1100U04 02	1100U04 03	1100U04 04	1100U04 05	1100U04 06	1.092
5	3	13	1100U05 01			1100U05 04			1.092
6	4	15	1100U06 01	1100U06 02	1100U06 03	1100U06 04	1100U06 05	1100U06 06	2.064
8	5.5	20	1100U08 01	1100U08 02	1100U08 03	1100U08 04	1100U08 05	1100U08 06	3.610
10	7	25	1100U10 01			1100U10 04			6.105
12	8	35	1100U12 01			1100U12 04			8.610
14	9.5	45	1100U14 01 95			1100U14 04 95			11.215
16	11	45	1100U16 01 11	1100U16 02 11	1100U16 03 11	1100U16 04 11			12.176

Inch tubing available upon request








2003U Polyurethane (PU) Ester Tubing

Drum 300 m

O.D. (mm)	I.D. (mm)								kg
10	7	25	2003U10 01	2003U10 02	2003U10 03	2003U10 04	2003U10 05	2003U10 06	16.600








2005U Polyurethane (PU) Ester Tubing

Drum 500 m

O.D. (mm)	I.D. (mm)								kg
8	5.5	20	2005U08 01	2005U08 02	2005U08 03	2005U08 04	2005U08 05		17.100

2010U Polyurethane (PU) Ester Tubing









Drum 1000 m

O.D. (mm)	I.D. (mm)								kg
4	2.5	12	2010U04 01	2010U04 02	2010U04 03	2010U04 04	2010U04 05	2010U04 06	9.840
6	4	15	2010U06 01	2010U06 02	2010U06 03	2010U06 04	2010U06 05	2010U06 06	20.460

PU Tubing









1025U..R Polyurethane (PU) Ether Tubing

Tubepack® 25 m

O.D. (mm)	I.D. (mm)									kg
4	2.5	12	1025U04R01	1025U04R04	1025U04R08	1025U04R12	1025U04R13	1025U04R14	1025U04R17	0.310
5	3	13			1025U05R08					0.522
6	4	15	1025U06R01	1025U06R04	1025U06R08	1025U06R12	1025U06R13	1025U06R14	1025U06R17	0.591
8	5.5	20	1025U08R01	1025U08R04	1025U08R08	1025U08R12	1025U08R13	1025U08R14	1025U08R17	0.971
10	7	25	1025U10R01	1025U10R04	1025U10R08			1025U10R14		1.467
12	8	35	1025U12R01	1025U12R04	1025U12R08			1025U12R14		2.406
14	9.5	45		1025U14R01 95	1025U14R04 95					2.815
16	11	45			1025U16R08 11					2.815





1100U..R Polyurethane (PU) Ether Tubing

Tubepack® 100 m

O.D. (mm)	I.D. (mm)									kg
4	2.5	12	1100U04R01	1100U04R04	1100U04R08	1100U04R12	1100U04R13	1100U04R14	1100U04R17	1.092
6	4	15	1100U06R01	1100U06R04	1100U06R08	1100U06R12	1100U06R13	1100U06R14	1100U06R17	2.064
8	5.5	20	1100U08R01	1100U08R04	1100U08R08	1100U08R12	1100U08R13	1100U08R14	1100U08R17	3.610
10	7	25			1100U10R08			1100U10R14		6.109
12	8	35			1100U12R04			1100U12R08		8.610
14	9.5	45			1100U14R08 95					11.215
16	11	45			1100U16R08 11					12.176





2003U..R Polyurethane (PU) Ether Tubing

Drum 300 m

O.D. (mm)	I.D. (mm)					kg
10	7	25	2003U10R01	2003U10R04	2003U10R08	16.600





2005U..R Polyurethane (PU) Ether Tubing

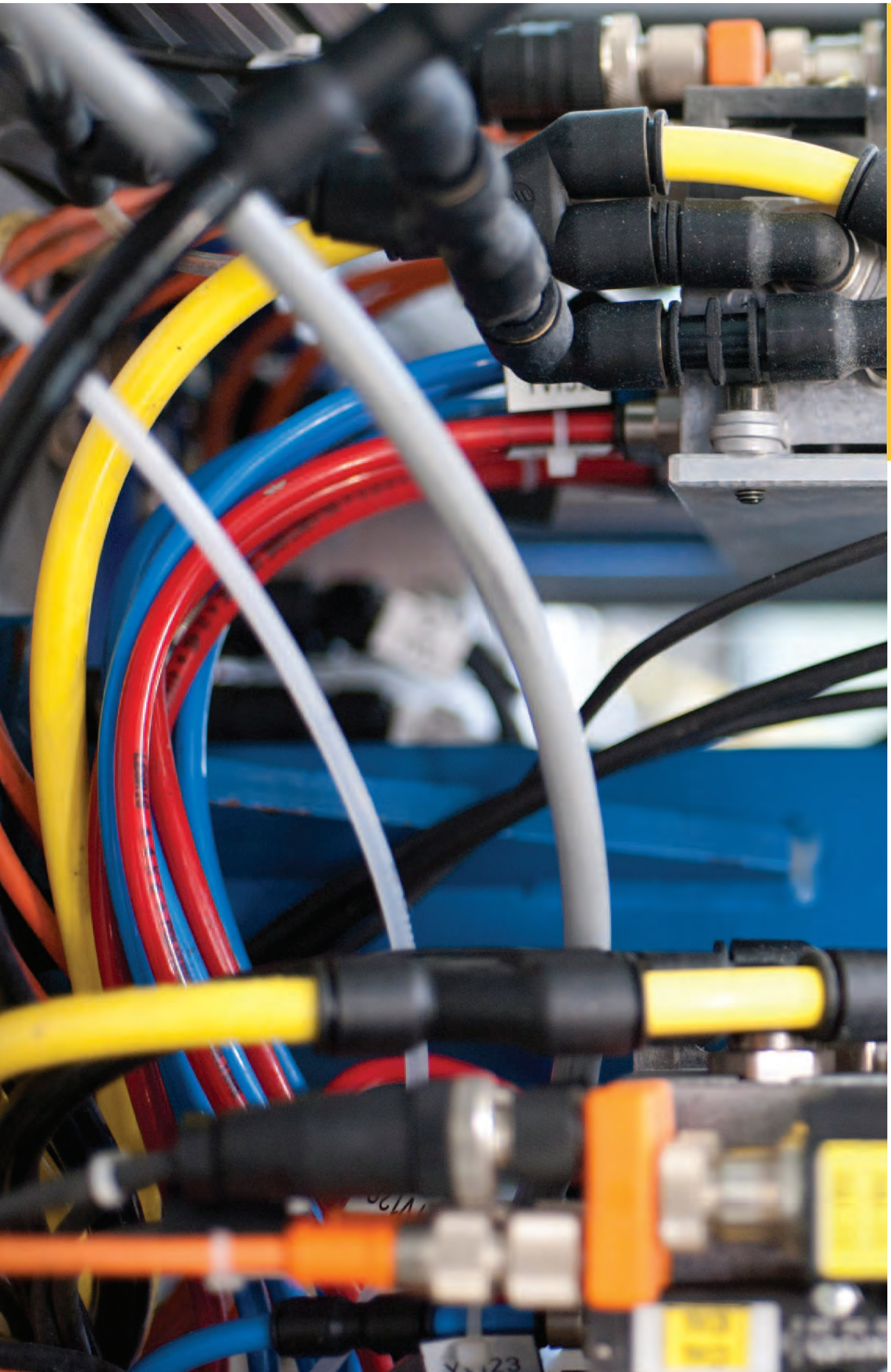
Drum 500 m

O.D. (mm)	I.D. (mm)					kg
8	5.5	20	2005U08R01	2005U08R04	2005U08R08	15.600

2010U..R Polyurethane (PU) Ether Tubing

Drum 1000 m

O.D. (mm)	I.D. (mm)					kg
4	2.5	12	2010U04R01	2010U04R04	2010U04R08	8.670
6	4	15	2010U06R01	2010U06R04	2010U06R08	18.600



Flexible Calibrated Tubing

Technical Tubing & Hose

Antistatic PU Tubing

With a constant **10² Ω.m resistivity** across the entire thickness of the tubing wall, this tubing guarantees **perfect dissipation of accumulated static electricity**, thereby increasing safety.

Product Advantages

Security

- Low resistivity throughout the material
- Suitable for ATEX* areas
- Superior longevity
- Excellent vibration absorption
- UV-resistant
- Silicone-free

Machinery Optimisation

- Minimum bend radius allowing maximum space saving
- Good chemical resistance
- Wide temperature range
- Stable chemical characteristics throughout tubing



Antistatic Packaging
Pneumatics
Electronics
Spray Painting
Electrical Converters

Applications

Technical Characteristics

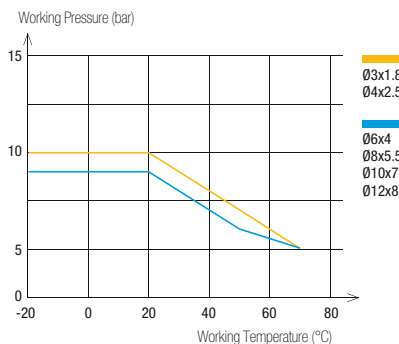
Compatible Fluids	Compressed air, industrial fluids
Working Pressure	Vacuum to 10 bar
Working Temperature	-20°C to +70°C
Component Materials	Polyurethane with conductive additive (50 shore D)

Regulations

DI: 94/9/EC (ATEX*)
DI: 1907/2006 (REACH)
DI: 2002/95/EC (RoHS), 2011/65/EC
*For ATEX areas, please consult us

Reliable performance is dependent upon the type of fluid conveyed and fittings being used. Use is guaranteed with a vacuum of 755 mm Hg (99% vacuum).

Performance of Antistatic PU Tubing



Tube O.D.	Tube O.D. Tolerance
3 to 8 mm	+0.10 / -0.10
10 to 12 mm	+0.15 / -0.15

Packaging



Tube pack: 25 m, 100 m

Connected to Parker Legris push-in fittings, the calibration of Parker Legris tubing ensures perfect sealing based on NF E49-101.

To calculate burst pressure, the values in this graph should be multiplied by 3.



1025U..A Anti-Static Polyurethane (PU) Ester Tubing

Tubepack® 25 m

O.D. (mm)	I.D. (mm)	 R		kg
4	2.5	12	1025U04A01	0.310
6	4	15	1025U06A01	0.591
8	5.5	25	1025U08A01	0.971

1100U..A Anti-Static Polyurethane (PU) Ester Tubing

Tubepack® 100 m

O.D. (mm)	I.D. (mm)	 R		kg
3	1.8	10	1100U03A01	0.836
4	2.5	12	1100U04A01	1.092
6	4	15	1100U06A01	2.064
8	5.5	25	1100U08A01	3.610
10	7	35	1100U10A01	6.105
12	8	45	1100U12A01	8.610

Flexible Calibrated Tubing

Technical Tubing & Hose

Related Products

To maintain the antistatic properties throughout the circuit, it is recommended that this tubing be used with metallic fittings.

Push-In Fittings

[LF 3600](#) P. 1-65



[LF 3800](#) P. 1-77



[LF 3900](#) P. 1-77



Compression Fittings

[Brass](#) P. 5-5



[Stainless Steel](#) P. 5-31



Anti-Spark PU Tubing

Combining **outstanding spark resistance** with superb **flexibility**, this range is perfectly suited for welding applications.

Two types of PU - ether with PVC sheath or single layer ether - are available and allow **rapid installation** with Parker Legris push-in fittings.

Product Advantages

- | | |
|---------------------------|--|
| PU with PVC Sheath | <ul style="list-style-type: none"> High resistance to kinking and abrasion Non-adhesive jacket facilitating sheath removal Fluid direction marking Self-extinguishing sheath, protecting the inner tubing Silicone-free |
| Single Layer PU | <ul style="list-style-type: none"> Minimum bend radius for maximum space saving Significant flexibility for rapid cycling Good chemical resistance Flow direction marking Fireproof material Silicone-free |



- Applications**
- Industrial Machinery
 - Compressed Air
 - Robotics
 - Mechanical Constraints
 - Cooling
 - Welding
 - Cabling

Technical Characteristics

Compatible Fluids	Industrial fluids, compressed air, coolants
Working Pressure	Vacuum to 14 bar
Working Temperature	-20°C to +70°C
Component Materials	PU ether with PVC sheath PU ether single layer

O.D. of Tube	Sheath Removal Length for LF 3600 (mm)
4 mm	15± 1
6 mm	18± 1
8 mm	19± 1
10 mm	24± 1
12 mm	25± 1

Regulations

UL94 V-0 (Fire resistance)
 DI: 2002/95/EC (RoHS),
 2011/65/EC
 RG: 1907/2006 (REACH)

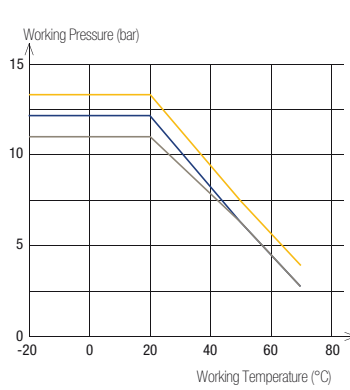
Packaging
 Tubepack*: 25 m, 100 m

Reliable performance is dependent upon the type of fluid conveyed and fittings being used. Use is guaranteed with a vacuum of 755 mm Hg (99% vacuum).

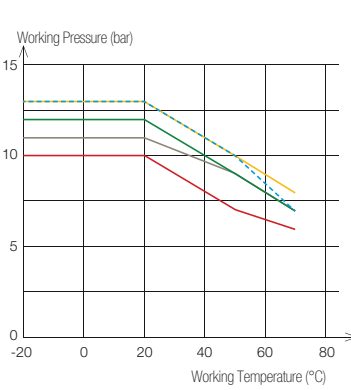
For other fitting ranges, please consult us.

Tubing Performance

Anti-Spark PU Tubing, with PVC Sheath



Anti-Spark PU Tubing, Single Layer








Tube O.D.	Tube O.D. Tolerance	Thickness and Tolerances of PVC Sheath
4 to 8 mm	+0.10 / -0.10	1mm +0.10 / -0.10
10 to 12 mm	+0.15 / -0.15	

Connected to Parker Legris push-in fittings, the calibration of Parker Legris tubing ensures perfect sealing based on NF E49-101 (inner tubing for sheathed or single layer tubing).

To calculate burst pressure, the values in these graphs should be multiplied by 3.






1025U..V Anti-Spark Sheath Polyurethane (PU) Ether Tubing

Tubepack® 25 m

O.D. (mm)	I.D. (mm)						kg
6	4	12	1025U06V01	1025U06V02	1025U06V03	1025U06V04	1.200
8	5.5	20	1025U08V01	1025U08V02	1025U08V03	1025U08V04	1.620
10	7	25	1025U10V01	1025U10V02	1025U10V03	1025U10V04	2.900
12	8	35	1025U12V01	1025U12V02	1025U12V03	1025U12V04	4.030






1100U..V Anti-Spark Sheath Polyurethane (PU) Ether Tubing

Tubepack® 100 m

O.D. (mm)	I.D. (mm)						kg
6	4	12	1100U06V01	1100U06V02	1100U06V03	1100U06V04	5.370
8	5.5	20	1100U08V01	1100U08V02	1100U08V03	1100U08V04	7.630
10	7	25	1100U10V01	1100U10V02	1100U10V03	1100U10V04	10.860
12	8	35	1100U12V01	1100U12V02	1100U12V03	1100U12V04	15.060






1025U..K Single Layer Anti-Spark Polyurethane (PU) Ether Tubing

Tubepack® 25 m



O.D. (mm)	I.D. (mm)						kg
4	2.5	12	1025U04K01	1025U04K02	1025U04K03	1025U04K04	0.230
6	4	15	1025U06K01	1025U06K02	1025U06K03	1025U06K04	0.580
8	5.5	20	1025U08K01	1025U08K02	1025U08K03	1025U08K04	0.860
10	7	25	1025U10K01	1025U10K02	1025U10K03	1025U10K04	1.230
12	8	35	1025U12K01	1025U12K02	1025U12K03	1025U12K04	2.080
14	9.5	45		1025U14K02 95	1025U14K03 95		2.620

1100U..K Single Layer Anti-Spark Polyurethane (PU) Ether Tubing

Tubepack® 100 m

O.D. (mm)	I.D. (mm)						kg
4	2.5	12	1100U04K01				0.900
6	4	15	1100U06K01	1100U06K02	1100U06K03	1100U06K04	2.320
8	5.5	20	1100U08K01	1100U08K02	1100U08K03	1100U08K04	3.030
10	7	25	1100U10K01	1100U10K02	1100U10K03	1100U10K04	5.100
12	8	35	1100U12K01	1100U12K02	1100U12K03	1100U12K04	8.600
14	9.5	45		1100U14K02 95	1100U14K03 95		10.676

6000 71 00 Stripping Tool for Anti-Spark Tubing

	Technical polymer, stainless steel		kg
		6000 71 00	0.098
Working principle of the stripping tool page 3-17			

PE Tubing

Parker Legris offers two types of polyethylene tubing: "**Advanced PE**" 50% reticulated and **Low Density PE**. Our range of "Advanced PE" is designed for demanding environments, especially that of water treatment, without compromising operator **safety**.

Product Advantages

Advanced PE | 50% reticulated material
 Best balance between flexibility and pressure/temperature resistance
 Resistant to a wide range of aggressive chemicals
 UV-stabilised: ideal for outdoor applications
 Approved for permanent contact with food and beverages
 Silicone-free

Low Density PE | Excellent resistance to aggressive and corrosive agents
 Good technical trade-off
 Food-grade material
 Silicone-free



Applications
 Beverage
 Chemical
 Petrochemical
 Food Process
 Water
 Water Treatment

Technical Characteristics

Tube	Advanced PE	Low Density PE
Compatible Fluids	Water, beverages and other fluids	Industrial fluids
Working Pressure	Vacuum to 16 bar	Vacuum to 20 bar
Working Temperature	-40°C to +95°C	-40°C to +60°C
Component Materials	High quality polyethylene: 50% reticulated PE 50% low density PE (44 shore D)	Low Density Polyethylene (44 shore D)

Regulations

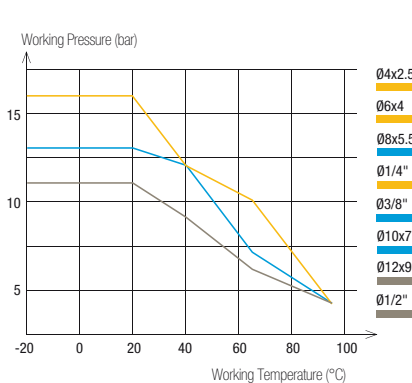
Advanced PE Tubing
 FDA: 21 CFR 177.1520
 RG: 1935/2004/EC
 DI: 97/23/EC (PED)
 DI: 2002/95/EC (RoHS), 2011/65/EC
 NSF 42/58 (1/4" and 3/8" approved for 10 bar and 1/2" approved for 8 bar at room temperature)
 NSF 51, 61 C-HOT
 ACS (except for purple colour)
 WRAS
 RG: 1907/2006 (REACH)

Low Density PE Tubing
 FDA: 21 CFR 177.1520
 DI: 2002/95/EC (RoHS), 2011/65/EC
 DI: 97/23/EC (PED)

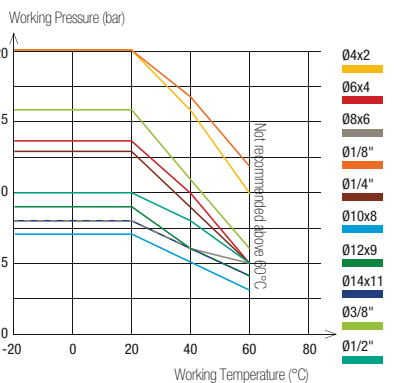
Reliable performance is dependent upon the type of fluid conveyed and fittings being used. Use is guaranteed with a vacuum of 755 mm Hg (99% vacuum).

Tubing Performance

Advanced PE Tubing



Low Density PE Tubing



Tube O.D.	Tube O.D. Tolerance
1/4" to 1/2"	+0.10 / -0.10
4 to 14 mm	+0.10 / -0.10

Connected to Parker Legris push-in fittings, the calibration of Parker Legris tubing ensures perfect sealing.

Packaging

Advanced PE Tubing
 Tubepack®: 75 m, 150 m, 300 m
 250 feet, 500 feet, 1 000 feet
 PE Tubing
 Tubepack®: 25 m, 100 m

To calculate burst pressure, the values in these graphs should be multiplied by 3.

1015Y..F Advanced Polyethylene (APE) Tubing

Drum 150 m

O.D. (mm)	I.D. (mm)	R	Clear	Black	Green	Red	Blue	Yellow	White	kg
4	2.5	16	1015Y04F00	1015Y04F01	1015Y04F02	1015Y04F03	1015Y04F04	1015Y04F05	1015Y04F10	1.760
6	4	32	1015Y06F00	1015Y06F01	1015Y06F02	1015Y06F03	1015Y06F04	1015Y06F05	1015Y06F10	2.580
8	5.75	40	1015Y08F00	1015Y08F01	1015Y08F02	1015Y08F03	1015Y08F04	1015Y08F05	1015Y08F10	4.050
10	7		1015Y10F00	1015Y10F01	1015Y10F02	1015Y10F03	1015Y10F04	1015Y10F05	1015Y10F10	6.200

1030Y..F Advanced Polyethylene (APE) Tubing

Drum 300 m

O.D. (mm)	I.D. (mm)	R	Clear	Black	Green	Red	Blue	Yellow	White	kg
4	2.5	16	1030Y04F00	1030Y04F01	1030Y04F02	1030Y04F03	1030Y04F04	1030Y04F05	1030Y04F10	2.860
6	4	32	1030Y06F00	1030Y06F01	1030Y06F02	1030Y06F03	1030Y06F04	1030Y06F05	1030Y06F10	4.800

1075Y..F Advanced Polyethylene (APE) Tubing

Drum 75 m

O.D. (mm)	I.D. (mm)	R	Clear	Black	Green	Red	Blue	Yellow	White	kg
12	9	55	1075Y12F00	1075Y12F01	1075Y12F02	1075Y12F03	1075Y12F04	1075Y12F05	1075Y12F10	5.550

1096Y..F Advanced Polyethylene (APE) Tubing

Drum 250 ft

O.D. (inch)	I.D. (inch)	R	Clear	Black	Green	Red	Blue	Yellow	White	kg
1/2	0.375	1.96	1096Y62F00	1096Y62F01	1096Y62F02	1096Y62F03	1096Y62F04	1096Y62F05	1096Y62F10	5.900

1098Y..F Advanced Polyethylene (APE) Tubing

Drum 500 ft

O.D. (inch)	I.D. (inch)	R	Clear	Black	Green	Red	Blue	Yellow	White	kg
1/4	0.170	0.78	1098Y56F00	1098Y56F01	1098Y56F02	1098Y56F03	1098Y56F04	1098Y56F05	1098Y56F10	3.300
3/8	0.250	1.18	1098Y60F00	1098Y60F01	1098Y60F02	1098Y60F03	1098Y60F04	1098Y60F05	1098Y60F10	6.300

1099Y..F Advanced Polyethylene (APE) Tubing

Drum 1000 ft

O.D. (inch)	I.D. (inch)	R	Clear	Black	Green	Red	Blue	Yellow	White	kg
1/4	0.170	0.78	1099Y56F00	1099Y56F01	1099Y56F02	1099Y56F03	1099Y56F04	1099Y56F05	1099Y56F10	5.500

Low Density Polyethylene (LDPE) Tubing

1025Y

Tubepack® 25 m

Ø ext. (inch)	Ø int. (inch)	R	Clear	kg
1/8	1.57	13	1025Y53 00	0.270
1/4	4.3	32	1025Y56 00	0.400
3/8	6.35	50	1025Y60 00	0.760
1/2	9.65	64	1025Y62 00	1.330

1100Y

Tubepack® 100 m

O.D. (mm)	I.D. (mm)	R	Clear	kg
4	2	25	1100Y04 00	0.910
6	4	35	1100Y06 00	1.500
8	6	55	1100Y08 00	2.140
10	8	80	1100Y10 00	2.710
12	9	65	1100Y12 00	4.750
14	11	80	1100Y14 00	5.650

Fluoropolymer Tubing – FEP

FEP (fluorinated ethylene propylene) tubing is a **robust engineering fluoropolymer** which provides excellent fluid visibility and is perfect for flow control monitoring.

Product Advantages

Flow Control | Transparent
Flexible and non-flammable material
Resistant to nearly all chemicals and solvents

Tried-&-Tested Properties | Excellent transmission of UV light
Low friction coefficient
Food-grade material
Low permeability
Easily weldable
Silicone-free

Applications

Instrumentation
Food Process
UV
Gas Sampling
Chemical
Temperature Cycling
Laboratory

Technical Characteristics

Compatible Fluids	Industrial fluids
Working Pressure	0 to 28 bar
Working Temperature	-40°C to +150°C
Component Materials	Fluorinated ethylene propylene (pure)

Regulations

Food

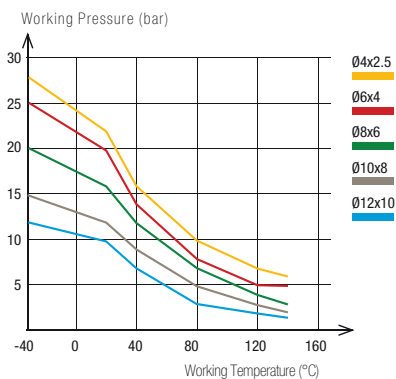
FDA: 21 CFR 177.1550
RG: 1935/2004

Industrial

UL94 V-0 (Fire resistance)
DI: 2002/95/EC (RoHS), 2011/65/EC
DI: 97/23/EC (PED)
RG: 1907/2006 (REACH)

Reliable performance is dependent upon the type of fluid conveyed and fittings being used.

Performance of FEP Tubing



Tube O.D.	Tube O.D. Tolerance
4 mm	+0.05 / -0.05
6 to 10 mm	+0.07 / -0.07
12 mm	+0.10 / -0.10



Packaging

TubePack®: 5 m, 25 m, 100 m

Connected to Parker Legris push-in fittings, the calibration of Parker Legris tubing ensures perfect sealing.



1005T Fluoropolymer (FEP) Tubing

Tubepack® 5 m

O.D. (mm)	I.D. (mm)	 R	 Clear	kg
4	2.5	40	1005T04 00 25	0.155
6	4	50	1005T06 00	0.250
8	6	70	1005T08 00	0.385
10	8	120	1005T10 00	0.524
12	10	180	1005T12 00	0.547

1025T Fluoropolymer (FEP) Tubing

Tubepack® 25 m

O.D. (mm)	I.D. (mm)	 R	 Clear	kg
4	2.5	40	1025T04 00 25	0.506
6	4	50	1025T06 00	1.025
8	6	70	1025T08 00	1.431
10	8	120	1025T10 00	1.693
12	10	180	1025T12 00	1.913

Flexible Calibrated Tubing

Technical Tubing & Hose

Related Products

Parker Legris stainless steel fittings are perfectly suited for use with fluoropolymer tubing (PFA, FEP).

Push-In Fittings

[LF 3800](#) P. 1-77

[LF 3900](#) P. 1-77

Compression Fittings

[Stainless Steel](#) P. 5-31



Fluoropolymer Tubing - PFA

Parker Legris **PFA** (perfluoroalkoxy) tubing offers **10 times greater durability** than other fluoropolymer tubings (PTFE, FEP and PVDF) under severe chemical and mechanical conditions. This tubing range is available in **three material grades**, offering perfect compatibility with all applications, even in extreme environments.

Product Advantages

Great Versatility

- Exceptional chemical inertia
- A flexible alternative to stainless steel tubing
- Broad range of working temperatures, from cryogenic to extreme heat
- Non-stick properties allowing conveyance of many fluids & gases
- Outstanding resistance to ageing
- Fluoropolymer with the lowest permeability
- Non-flammable
- UV-transparent
- Tube marking on request
- Silicone-free

Three Material Grades

- Clear High Purity PFA: to cover all applications, including those requiring maximum mechanical resistance
- Coloured PFA: for circuit identification
- Black Antistatic PFA: eliminates all risk of electrostatic discharge



- Applications**
- Food-Process
 - Fuel Cells
 - Electrical/Electronics
 - Aircraft
 - Oil/Gas Industry
 - Pharmaceutical
 - Medical
 - Chemical
 - Clean Rooms

Technical Characteristics

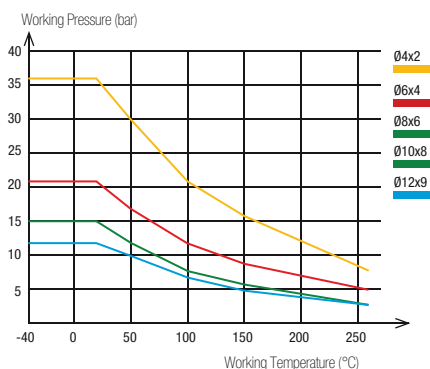
Compatible Fluids	Medical, bio-compatible, food process, gas, compressed air
Working Pressure	Vacuum to 36 bar
Working Temperature	-196°C to +260°C
Component Materials	Perfluoroalkoxy <ul style="list-style-type: none"> • High Purity PFA • Translucent coloured PFA • Antistatic PFA

Reliable performance is dependent upon the type of fluid conveyed and fittings being used. Use is guaranteed with a vacuum of 755 mm Hg (99% vacuum).

Regulations

- Medical**
 USP: Class VI (A)
 External communication devices
- Industrial**
 UL94 V-0 (Fire resistance)
 DI: 2002/95/EC (RoHS), 2011/65/EC
 DI: 97/23/EC (PED)
 RG: 1907/2006 (REACH)
 DI: 94/09/EC (ATEX, black tubing)
- Food Industry**
 FDA: 21 CFR 177.1550
 (clear, translucent coloured)
 RG: 1935/2004
 NSF 51 (material)

Performance of PFA Tubing



Tube O.D.	Tube O.D. Tolerance
4 to 8 mm	+0.10 / -0.10
10 to 12 mm	+0.15 / -0.15






Packaging
 Tubepack®: 10 m, 50 m, 100 m

Connected to Parker Legris push-in fittings, the calibration of Parker Legris tubing ensures perfect sealing based on NF E49-100.

To calculate burst pressure, the values in this graph should be multiplied by 3.






1010T..P Fluoropolymer (PFA) Tubing

Tubepack® 10 m

O.D. (mm)	I.D. (mm)		 Clear	 crystal	 crystal	 crystal	kg
4	2	12	1010T04P00	1010T04P12	1010T04P13	1010T04P14	0.087
6	4	34	1010T06P00	1010T06P12	1010T06P13	1010T06P14	0.237
8	6	60	1010T08P00	1010T08P12	1010T08P13	1010T08P14	0.410
10	8	95	1010T10P00	1010T10P12	1010T10P13	1010T10P14	0.723
12	9	120	1010T12P00	1010T12P12	1010T12P13	1010T12P14	1.148






1050T..P Fluoropolymer (PFA) Tubing

Tubepack® 50 m

O.D. (mm)	I.D. (mm)		 Clear	 crystal	 crystal	 crystal	kg
4	2	12	1050T04P00	1050T04P12	1050T04P13	1050T04P14	0.435
6	4	34	1050T06P00	1050T06P12	1050T06P13	1050T06P14	1.185
8	6	60	1050T08P00	1050T08P12	1050T08P13	1050T08P14	2.050
10	8	95	1050T10P00	1050T10P12	1050T10P13	1050T10P14	3.615
12	9	120	1050T12P00	1050T12P12	1050T12P13	1050T12P14	5.740



1100T..P Fluoropolymer (PFA) Tubing

Tubepack® 100 m

O.D. (mm)	I.D. (mm)		 Clear	 crystal	 crystal	 crystal	kg
4	2	12	1100T04P00	1100T04P12	1100T04P13	1100T04P14	0.870
6	4	34	1100T06P00	1100T06P12	1100T06P13	1100T06P14	2.370
8	6	60	1100T08P00	1100T08P12	1100T08P13	1100T08P14	4.100
10	8	95	1100T10P00	1100T10P12	1100T10P13	1100T10P14	7.230
12	9	120	1100T12P00	1100T12P12	1100T12P13	1100T12P14	11.480



1010T..A Fluoropolymer (PFA) Antistatic Tubing

Tubepack® 10 m

O.D. (mm)	I.D. (mm)			kg
4	2	12	1010T04A01	0.087
6	4	34	1010T06A01	0.237
8	6	60	1010T08A01	0.410
10	8	95	1010T10A01	0.723
12	9	120	1010T12A01	1.148

1050T..A Fluoropolymer (PFA) Antistatic Tubing

Tubepack® 50 m

O.D. (mm)	I.D. (mm)			kg
4	2	12	1050T04A01	0.435
6	4	34	1050T06A01	1.185
8	6	60	1050T08A01	2.050
10	8	95	1050T10A01	0.362
12	9	120	1050T12A01	5.740

Multi-Tubing

Our range of multi-tubing combines high quality performance and **space optimisation** in complex pneumatic circuits **covering a wide range of environments**. **Many possible configurations** are available, depending on the pressure, temperature, flexibility and compatibility requirements.

Product Advantages

Sheathed PA Tubing

- PVC sheath resistant to external damage:
 - abrasion
 - weld spatter
 - aggressive fluids
- Helically wound: minimum bend radius, compact installation
- Simplified routing
- Easy identification of circuits
- Same technical performance as PA
- Possible number of tubes: from 2 to 12, with numbering
- Silicone-free

Twin PU Ester Tubing

- Tubes fully joined for improved solidity
- External diameter maintained after separation
- Rapid identification of circuits
- Quick and easy installation
- Simplified routing
- 3 colour combinations available
- Silicone-free



Applications

Pneumatics
Automation
Robotics
Transportation
In-Plant Automotive
Process Industry

Technical Characteristics

Tube	PA	PU
Compatible Fluids	Compressed air, chemicals, industrial fluids	Compressed air, industrial fluids
Working Pressure	Vacuum to 24 bar	0 to 14 bar
Working Temperature	-40°C to +80°C	-20°C to +70°C
Component Materials	Polyamide	Polyurethane ester

Reliable performance is dependent upon the type of fluid conveyed and fittings being used. Use is guaranteed with a vacuum of 755 mm Hg (99% vacuum).

Regulations

Industrial
 DI: 2002/95/EC (RoHS), 2011/65/EC
 DI: 97/23/EC (PED)
 RG: 1907/2006 (REACH)
 Performance and chemical resistance according to DIN 73378

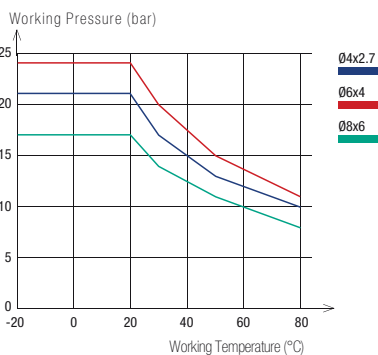
Packaging

Sheathed PA Tubing:
 Tube-pack® 10 m, 50 m

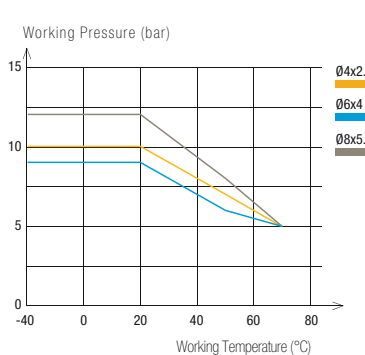
Twin PU Ester Tubing:
 Tube-pack® 25 m

Tubing Performance

Sheathed PA Tubing



Twin PU Ester Tubing





Material	Tube O.D.	Tube O.D. Tolerance
PA	4 mm	+0.05 / -0.08
	6 to 8 mm	+0.05 / -0.10
PU	4 to 8 mm	+0.10 / -0.10

Connected to Parker Legris push-in fittings, the calibration of Parker Legris tubing ensures perfect sealing based on NF E49-100 (for semi-rigid PA) and NF E49-101 (for twin PU ester).

To calculate burst pressure, the values in these graphs should be multiplied by 3.



1010P.. M Semi-Rigid Polyamide (PA) Multi-Tubing

Reel 10 m

O.D. (mm)	I.D. (mm)		Number of tubes		kg
4	2.7	35	4	1010P04 00M04	1.440
4	2.7	45	7	1010P04 00M07	1.920
6	4	55	4	1010P06 00M04	2.300
6	4	60	7	1010P06 00M07	2.900
8	6	45	2	1010P08 00M02	2.600





1050P.. M Semi-Rigid Polyamide (PA) Multi-Tubing

Reel 50 m

O.D. (mm)	I.D. (mm)		Number of tubes		kg
4	2.7	20	2	1050P04 00M02	4.400
4	2.7	35	4	1050P04 00M04	6.600
4	2.7	45	7	1050P04 00M07	8.200
4	2.7	55	12	1050P04 00M12	12.444
6	4	45	2	1050P06 00M02	8.400
6	4	55	4	1050P06 00M04	14.500
6	4	60	7	1050P06 00M07	12.500
8	6	45	2	1050P08 00M02	13.000

1420U Twin Polyurethane (PU) Tubing

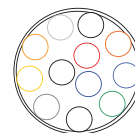
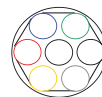
Tubepack® 25 m

O.D. tube (mm)	I.D. tube (mm)					kg
4	2.5	12	1420U04 11	1420U04 44	1420U04 41	0.620
6	4	15	1420U06 11	1420U06 44	1420U06 41	1.182
8	5.5	20	1420U08 11	1420U08 44	1420U08 41	1.942

Colour Selection



Multi-Tubing
Semi-Rigid PA/PVC Sheath



Related Products

To complement the Multi-Tubing range, Parker Legris proposes multi-connectors, shown in Chapter 1.

Push-In Fittings

Multi-Connector P. 1-31



PA Recoil Tubing

Parker Legris recoil tubing has a **lasting memory after multiple uses**, offering an **alternative to reels** for excellent ergonomics and space saving.

The pre-assembled tubes are equipped with a protection spring, preventing damage to the ends.

Product Advantages

Excellent Mechanical Properties

- Low pressure drop
- Good chemical compatibility
- Self-retracting
- Identical technical performance to PA tubing
- Silicone-free

Comprehensive Range

- Ready-to-use
- Various colours for circuit identification
- Available with pre-assembled connectors



Applications

- MRO
- Pneumatic Tools
- Transportation
- Lubrication
- Industrial Cleaning
- Robotics
- Car Washing

Technical Characteristics

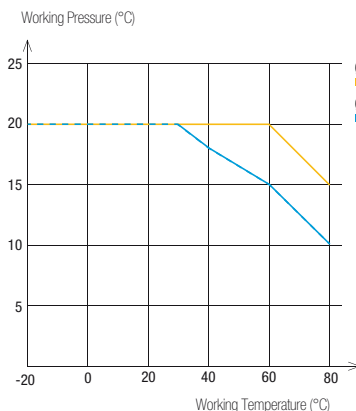
Compatible Fluids	Compressed air, lubricants, Other fluids: please consult us
Working Pressure	Vacuum to 20 bar
Working Temperature	-20°C to +80°C
Component Materials	Polyamide (68 Shore D)

Regulations

DI: 97/23/EC (PED)
 RG: 1907/2006 (REACH)
 DI: 2002/95/EC (RoHS), 2011/65/EC

Reliable performance is dependent upon the type of fluid conveyed and fittings being used. Use is guaranteed with a vacuum of 755 mm Hg (99% vacuum).

Performance of PA Recoil Tubing





Tube O.D.	Passage	Tube O.D. Tolerance
6 mm	4 mm	+0.05 / -0.10
8 mm	6 mm	+0.05 / -0.10

Packaging

Plastic bags: 2m to 6 m
 Other lengths and colours on request



To calculate burst pressure, the values in these graphs should be multiplied by 3.

1470P Polyamide (PA) Recoil Tubing 2 m, Male BSPT Fitting

O.D. (mm)	I.D. (mm)	BSPT Thread			Total Closed Length (mm)	O.D. of Coil (mm)	kg
6	4	R1/4	1470P06 04 13	1470P06 07 13	520	60	0.143
8	6		1470P08 04 13	1470P08 07 13	560	70	0.174

Length of long straight section: 300 mm
Length of short straight section: 100 mm

1471P Polyamide (PA) Recoil Tubing 4 m, Male BSPT Fitting

O.D. (mm)	I.D. (mm)	BSPT Thread			Total Closed Length (mm)	O.D. of Coil (mm)	kg
6	4	R1/4	1471P06 04 13	1471P06 07 13	640	60	0.199
8	6		1471P08 04 13	1471P08 07 13	720	70	0.249

Length of long straight section: 300 mm
Length of short straight section: 100 mm

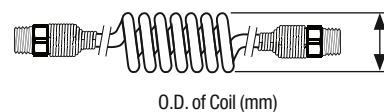
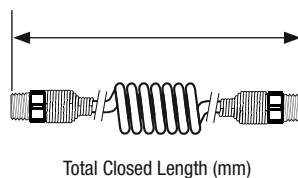
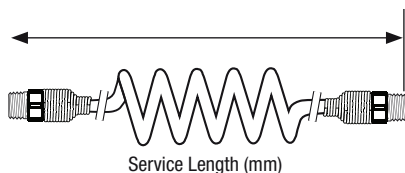
1472P Polyamide (PA) Recoil Tubing 6 m, Male BSPT Fitting

O.D. (mm)	I.D. (mm)	BSPT Thread			Total Closed Length (mm)	O.D. of Coil (mm)	kg
6	4	R1/4	1472P06 04 13	1472P06 07 13	760	60	0.260
8	6		1472P08 04 13	1472P08 07 13	880	70	0.329

Length of long straight section: 300 mm
Length of short straight section: 100 mm

Dimensions for Recoil Tubing

Service length: maximum recommended operating length in order to ensure that the coil will continue to contract after multiple uses.



PU Recoil Tubing

With its small coil diameter and good impact resistance, this polyurethane recoil tubing is perfect for installations requiring **flexibility** in confined spaces. Good resistance to shock and abrasion, together with a design integrating straight ends, allow for **easy and safe operation** of pneumatic equipment.

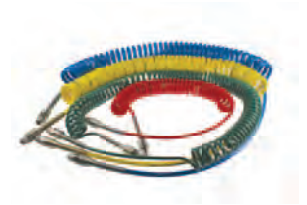
Product Advantages

Excellent Mechanical Properties

- Excellent coil memory
- Abrasion-resistant
- Perfect for rapid cycling applications
- Consistent tensile strength
- Optimum longevity
- Low pressure drop
- Lightweight with plastic protection spring
- Silicone-free

Comprehensive Range

- Available in 2 materials: PU ester and PU ether
- With or without pre-assembled fittings
- Pre-assembled plastic or metal protection springs to prevent damage to equipment and tubing



Applications

- Workshops
- Tooling
- Pneumatics
- Motion Technologies
- Robotics
- Industrial Machinery

Technical Characteristics

Compatible Fluids	Compressed air
Working Pressure	0 to 10 bar
Working Temperature	-20°C to +70°C (assembled tubing)
Component Materials	Polyurethane (52 Shore D)

Regulations

Industrial
 NF E49-101
 DI: 2002/95/EC (RoHS), 2011/65/EC
 DI: 97/23/EC (PED)
 RG: 1907/2006 (REACH)

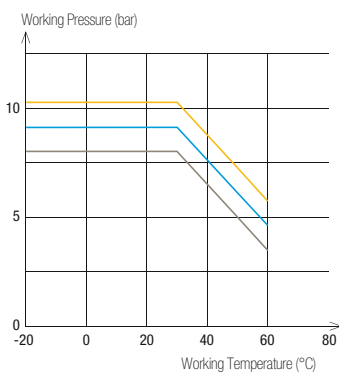
Packaging

Plastic bags : from 2 m to 7.5 m

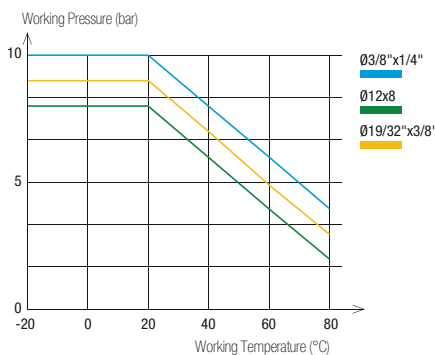
Reliable performance is dependent upon the type of fluid conveyed and fittings being used.

Performance of PU Recoil Tubing

PU Ester Recoil Tubing






PU Ether Recoil Tubing



Tube O.D.	Tube I.D.	Tube O.D. Tolerance
4 to 8 mm	2.5 to 5.5 mm	+0.10 / -0.10
10 to 12 mm	7 to 8 mm	+0.15 / -0.15
3/8" and 19/32"	1/4" and 3/8"	+/- 0.005"




To calculate burst pressure, the values in these graphs should be multiplied by 3.

1470U Polyurethane (PU) Ester Recoil Tubing 2 m, Male BSPT Fitting

O.D. (mm)	I.D. (mm)	BSPT Thread				Total Closed Length (mm)	O.D. of Coil (mm)	kg
4	2.5	R1/8	1470U04 03 10	1470U04 04 10	1470U04 05 10	595	24	0.060
6	4	R1/4	1470U06 03 13	1470U06 04 13	1470U06 05 13	630	32	0.060
8	5	R1/4	1470U08 03 13	1470U08 04 13	1470U08 05 13	780	42	0.120
10	7	R1/4	1470U10 03 13	1470U10 04 13	1470U10 05 13	780	62	0.160
12	8	R3/8	1470U12 03 17	1470U12 04 17	1470U12 05 17	780	65	0.190




Length of long straight section, O.D. < 8 mm: 300 mm; Length of long straight section, O.D. ≥ 8 mm: 500 mm; Length of short straight section, for all O.D.: 100 mm

1471U Polyurethane (PU) Ester Recoil Tubing 4 m, Male BSPT Fitting

O.D. (mm)	I.D. (mm)	BSPT Thread				Total Closed Length (mm)	O.D. of Coil (mm)	kg
4	2.5	R1/8	1471U04 03 10	1471U04 04 10	1471U04 05 10	785	24	0.100
6	4	R1/4	1471U06 03 13	1471U06 04 13	1471U06 05 13	850	32	0.160
8	5	R1/4	1471U08 03 13	1471U08 04 13	1471U08 05 13	1000	42	0.200
10	7	R1/4	1471U10 03 13	1471U10 04 13	1471U10 05 13	1000	62	0.230
12	8	R3/8	1471U12 03 17	1471U12 04 17	1471U12 05 17	1140	65	0.260


Length of long straight section, O.D. < 8 mm: 300 mm; Length of long straight section, O.D. ≥ 8 mm: 500 mm; Length of short straight section, for all O.D.: 100 mm

1472U Polyurethane (PU) Ester Recoil Tubing 6 m, Male BSPT Fitting

O.D. (mm)	I.D. (mm)	BSPT Thread				Total Closed Length (mm)	O.D. of Coil (mm)	kg
8	5	R1/4	1472U08 03 13	1472U08 04 13	1472U08 05 13	1230	42	0.280
10	7	R1/4	1472U10 03 13	1472U10 04 13	1472U10 05 13	1140	62	0.295
12	8	R3/8	1472U12 03 17	1472U12 04 17	1472U12 05 17	1190	65	0.310


Length of long straight section, O.D. < 8 mm: 300 mm; Length of long straight section, O.D. ≥ 8 mm: 500 mm; Length of short straight section, for all O.D.: 100 mm

1460U Polyurethane (PU) Ester Recoil Tubing 2 m

O.D. (mm)	I.D. (mm)		Total Closed Length (mm)	O.D. of Coil (mm)	kg
8	5	1460U08 04	780	42	0.064
10	7	1460U10 04	780	62	0.122
12	8	1460U12 04	780	65	0.172


Length of long straight section, O.D. < 8 mm: 300 mm; Length of long straight section, O.D. ≥ 8 mm: 500 mm; Length of short straight section, for all O.D.: 100 mm

1461U Polyurethane (PU) Ester Recoil Tubing 4 m

O.D. (mm)	I.D. (mm)		Total Closed Length (mm)	O.D. of Coil (mm)	kg
8	5	1461U08 04	1000	42	0.128
10	7	1461U10 04	1000	62	0.244
12	8	1461U12 04	1000	65	0.344

Length of long straight section, O.D. < 8 mm: 300 mm; Length of long straight section, O.D. ≥ 8 mm: 500 mm; Length of short straight section, for all O.D.: 100 mm


1462U Polyurethane (PU) Ester Recoil Tubing 6 m

O.D. (mm)	I.D. (mm)		Total Closed Length (mm)	O.D. of Coil (mm)	kg
8	5	1462U08 04	1230	42	0.192
10	7	1462U10 04	1140	62	1.246
12	8	1462U12 04	1190	65	0.280


Length of long straight section, O.D. < 8 mm: 300 mm; Length of long straight section, O.D. ≥ 8 mm: 500 mm; Length of short straight section, for all O.D.: 100 mm

PU Recoil Tubing


1445U..R Recoil Polyurethane (PU) Ether Tubing 3 m, Male BSPP Fitting

O.D. (mm)	I.D. (mm)	BSPP Thread		Total Closed Length (mm)	O.D. of Coil (mm)	kg
8	5	G1/4	1445U08R04 13	819	40	0.170
3/8"	1/4"	G1/4	1445U60R04 13	769	60	0.230
12	8	G3/8	1445U12R04 17	789	80	0.310
14	9.5	G3/8	1445U14R04 17	759	110	0.460


1441U..R Recoil Polyurethane (PU) Ether Tubing 4 m, Male BSPP Fitting

O.D. (mm)	I.D. (mm)	BSPP Thread		Total Closed Length (mm)	O.D. of Coil (mm)	kg
8	5	G1/4	1441U08R04 13	889	40	0.220
3/8"	1/4"	G1/4	1441U60R04 13	819	60	0.260
12	8	G3/8	1441U12R04 17	849	80	0.400
14	9.5	G3/8	1441U14R04 17	809	110	0.554

1442U..R Recoil Polyurethane (PU) Ether Tubing 6 m, Male BSPP Fitting


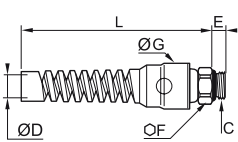

O.D. (mm)	I.D. (mm)	BSPP Thread		Total Closed Length (mm)	O.D. of Coil (mm)	kg
8	5	G1/4	1442U08R04 13	1029	40	0.340
3/8"	1/4"	G1/4	1442U60R04 13	929	60	0.360
12	8	G3/8	1442U12R04 17	969	80	0.530
14	9.5	G3/8	1442U14R04 17	909	110	0.920

1447U..R Recoil Polyurethane (PU) Ether Tubing 7.5 m, Male BSPP Fitting


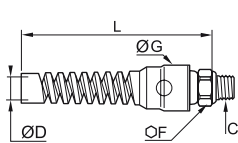

O.D. (mm)	I.D. (mm)	BSPP Thread		Total Closed Length (mm)	O.D. of Coil (mm)	kg
8	5	G1/4	1447U08R04 13	1134	40	0.420
3/8"	1/4"	G1/4	1447U60R04 13	1009	60	0.460
12	8	G3/8	1447U12R04 17	1059	80	0.600
14	9.5	G3/8	1447U14R04 17	984	110	1.150

Accessories

0694 Push-In Fitting with Protection Spring, Male BSPP Thread

		Nickel-plated brass, NBR		ØD	C		E	F	G	L	kg
		8	G1/4	0694 08 13	6.5	16	24	104.5	0.067		
		10	G1/4	0694 10 13	6.5	18	24	106.5	0.062		
		12	G3/8	0694 12 17	7.5	20	29.5	126	0.080		

0695 Push-In Fitting with Protection Spring, Male BSPT Thread

		Nickel-plated brass, NBR		ØD	C		F	G	L	kg
		8	R1/4	0695 08 13	14	24	104.5	0.055		
		10	R1/4	0695 10 13	18	24	106.5	0.064		
		12	R3/8	0695 12 17	20	29.5	126	0.090		

Braided PU Recoil Hose

This recoil hose offers all the advantages of polyurethane, combining the **durability** and **kink resistance** of bulkier braided hoses with great **elasticity** and maximum **flexibility**.

Product Advantages

Excellent Mechanical Properties

Unsurpassed resistance to abrasion: 10 times better than rubber, polyamide and non-braided polyurethane
 Excellent flexibility and coil memory: minimizes work fatigue
 Highly kink and crush-resistant
 Silicone-free

Ready-to-Use

Pre-assembled threaded fittings
 Tube ends protected with a plastic spring
 Lightweight for easy handling
 3 lengths available
 Translucent blue: visibility of the fluid



Machine Tools
 Industrial Assembly
 Pneumatics
 In-Plant Automotive
 Workshops

Applications

Technical Characteristics

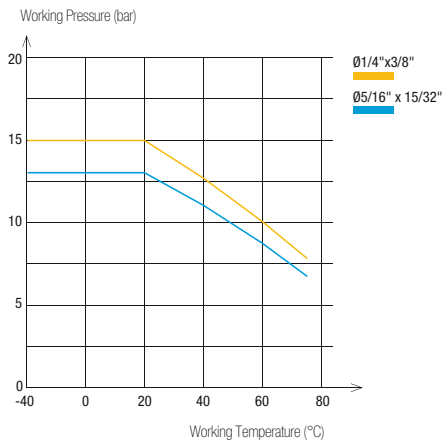
Compatible Fluids	Compressed air Other fluids: please consult us
Working Pressure	0 to 15 bar
Working Temperature	-40°C to +75°C
Component Materials	Polyurethane (85 shore A)

Regulations

DI: 97/23/EC(PED)
 RG: 1907/2006 (REACH)
 DI: 2002/95/EC (RoHS), 2011/65/EC

Reliable performance is dependent upon the type of fluid conveyed and fittings being used.

Performance of Braided PU Recoil Hose



Hose O.D.	Hose I.D.	Hose I.D. Tolerance
3/8" 15/32"	1/4" 5/16"	+/- 0.005"


Connected to Parker Legris push-in fittings, the calibration of PU tubing ensures perfect sealing.

Packaging


Plastic bags : 3 m to 7.5 m

To calculate burst pressure, the values in this graph should be multiplied by 4.


1445U..E Braided Polyurethane (PU) Recoil Hose 3 m, Male BSPP Fitting

Ø ext. (mm)	I.D. (mm)	BSPP Thread		Total Closed Length (mm)	O.D. of Coil (mm)	kg
3/8"	1/4"	G1/4	1445U60E04 13	870	42	0.210
12	8	G3/8	1445U12E04 17	880	55	0.300

1442U..E Braided Polyurethane (PU) Recoil Hose 6 m, Male BSPP Fitting

O.D. (mm)	I.D. (mm)	BSPP Thread		Total Closed Length (mm)	O.D. of Coil (mm)	kg
3/8"	1/4"	G1/4	1442U60E04 13	1140	42	0.420
12	8	G3/8	1442U12E04 17	1160	55	0.600

1447U..E Braided Polyurethane (PU) Recoil Hose 7.5 m, Male BSPP Fitting

O.D. (mm)	I.D. (mm)	BSPP Thread		Total Closed Length (mm)	O.D. of Coil (mm)	kg
3/8"	1/4"	G1/4	1447U60E04 13	1275	42	0.525
12	8	G3/8	1447U12E04 17	1300	55	0.750

Related Products

Parker Legris recoil tubing is designed for use with Parker Legris blowguns and couplers.

Industrial Blowguns

Polymer P. 7-3



Metal P. 7-12



Couplers

C 9000 P. 8-7



Metal P. 8-18



PVC Braided Hose

Parker Legris offers two **grades of PVC** which cover a wide range of industrial applications for the **transportation of various fluids**.

Product Advantages

Food-Grade PVC

Monograde tubing reinforced with a braided polyester ply
 Flexible: space saving during installation
 Translucent for visual identification:
 • of the fluid
 • of inner cleanliness
 • of fluid flow
 Food-grade, without phtalates
 Silicone-free

Industrial PVC

Tubing with a braided polyester ply between 2 grades of PVC
 Resistant to abrasion, impact and crushing
 Increased durability
 Lightweight and easy-to-use
 Silicone-free



Applications
 Robotics
 In-Plant Automotive
 Pneumatics
 Semi-Conductors
 Textile
 Packaging
 Vacuum

Technical Characteristics

Hose	Food-Grade PVC	Industrial PVC
Compatible Fluids	Compressed air, other fluids	Compressed air
Working Pressure	0 to 15 bar	0 to 15 bar
Working Temperature	-20°C to +70°C	-25°C to +60°C
Component Materials	Translucent food-grade PVC, phtalate-free with polyester braid	Industrial blue PVC, multi-layer, with polyester braid

Regulations

Food-Grade PVC

FDA: 21 CFR 177.1550
 RG: 1907/2006 (REACH)
 RG: 1935/2004
 DI: 2002/95/EC (RoHS), 2011/65/EC
 DI: 2007/10/EC (phtalates)

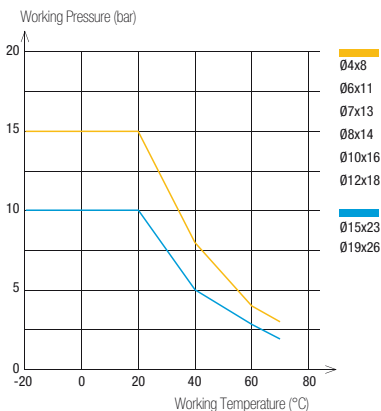
Industrial PVC

DI: 97/23/CE (PED)
 RG: 1907/2006 (REACH)
 DI: 2002/95/EC (RoHS), 2011/65/EC

Reliable performance is dependent upon the type of fluid conveyed and fittings being used.

Hose Performance

Food-Grade PVC



Hose Type	Hose I.D.	Hose I.D. Tolerance
Food-Grade PVC	4 to 6 mm	+0.5 / -0.5
	7 to 12 mm	+0.6 / -0.6
	15 to 19 mm	+0.8 / -0.8
Industrial PVC	6.3 mm	+0.3 / -0.3
	9 mm	+0.5 / -0.5
	12.7 mm	+0.6 / -0.6

Packaging



Reel: 25 m, 50 m
 (with protective plastic bag)

To calculate burst pressure, the values in these graphs should be multiplied by 3.

1025V

Food-Grade Braided PVC Hose



Reel 25 m

O.D. (mm)	I.D. (mm)	 R	 Clear	kg
8	4	10	1025V08 00 04	1.260
11	6	12	1025V11 00 06	2.253
13	7	14	1025V13 00 07	3.182
14	8	16	1025V14 00 08	3.434
16	10	25	1025V16 00 10	3.800
18	12	30	1025V18 00 12	4.423
23	15	40	1025V23 00 15	7.300
26	19	60	1025V26 00 19	7.300

1050V

Food-Grade Braided PVC Hose



Reel 50 m

O.D. (mm)	I.D. (mm)	 R	 Clear	kg
8	4	10	1050V08 00 04	2.690
11	6	12	1050V11 00 06	4.200
13	7	14	1050V13 00 07	5.966
14	8	16	1050V14 00 08	6.058
16	10	25	1050V16 00 10	6.400
18	12	30	1050V18 00 12	8.250
23	15	40	1050V23 00 15	14.600
26	19	60	1050V26 00 19	14.600

1025V..C

Industrial-Grade Braided PVC Hose



Reel 25 m

O.D. (mm)	I.D. (mm)	 R		kg
11	6	45	1025V11C04 06	2.175
14	9	63	1025V14C04 09	3.250
19	13	89	1025V19C04 13	4.975

1050V..C

Industrial-Grade Braided PVC Hose

Reel 50 m

O.D. (mm)	I.D. (mm)	 R		kg
11	6	45	1050V11C04 06	4.350
14	9	63	1050V14C04 09	6.500
19	13	89	1050V19C04 13	9.950

Related Products

PVC tubing is designed for use with Parker Legris barb connectors and couplers.

Barb Connectors

0191 P. 9-16



0123 P. 9-10



Couplers

C 9000 P. 8-7



Metal P. 8-18



Self-Fastening NBR Hose

Parker Legris self-fastening hose is designed according to **CNOMO E07.21.115N***. This range of hose should be used with Legris barb connectors and provides both the **reliability** of self-fastening technology and **simplicity of installation**.

Product Advantages

Exceptional Endurance | Unsurpassed resistance to repetitive flexing
 Protection against spark and flame
 Abrasion and crush-resistant
 UV-resistant

Ideal for In-Plant Automotive | Excellent ozone resistance
 Perfect for cooling systems
 Maximum flow with no pressure drop
 4 colours for immediate circuit identification
 Silicone-free

Ready-To-Use | No lubrication, additive (grease, oil, ...etc), or preparation time required
 To connect: push the hose fully home against the fitting shoulder
 To disassemble: cut the hose on the barbed side of the fitting



In-Plant Automotive
 Cooling
 Welding Robots
 Pneumatics
 Industrial Machinery

Applications

Technical Characteristics

Compatible Fluids	Coolants, compressed air
Working Pressure	0 to 16 bar
Working Temperature	-20°C to +100°C
Component Materials	Nitrile butadiene rubber & textile braid

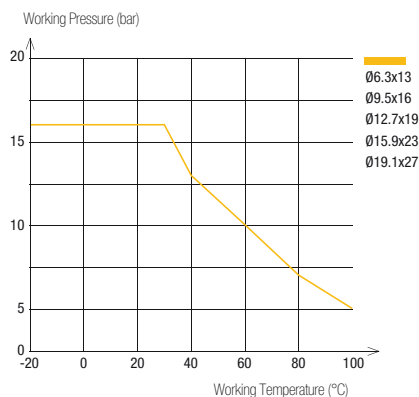
Regulations

NFT 46-019-1
 NFT 47 252
 RG: 1907/2006 (REACH)
 DI: 2002/95/EC (RoHS), 2011/65/EC
 CNOMO: E07.21.115N

***CAUTION:** CNOMO certification is valid exclusively for red and green hose, only when connected to Legris' CNOMO-certified barb connectors 0132, 0133 and 0134.

Reliable performance is dependent upon the type of fluid conveyed and fittings being used.

Performance of Self-Fastening NBR Hose



DN mm CNOMO	DN (standard)	Hose I.D. (mm)	Hose I.D. Tolerance (mm)
6	1/4	6.3 mm	+0.4 / -0.4
8	3/8	9.5 mm	+0.5 / -0.5
12	1/2	12.7 mm	+0.6 / -0.6
16	5/8	15.9 mm	
20	3/4	19.1 mm	

Packaging






Drum: 20 m, 40 m, 80 m, 100 m

Use with water: maximum temperature 100°C
 Use with air: maximum temperature 70°C

To calculate burst pressure, the values in this graph should be multiplied by 3.

1040H Braided Self-Fastening NBR Hose






Drum 40 m

DN	O.D. (mm)	I.D. (mm)						kg
1/4	13	6.3	60	1040H56 01	1040H56 02	1040H56 03	1040H56 04	7.000
3/8	16	9.5	70	1040H60 01	1040H60 02	1040H60 03	1040H60 04	8.600
1/2	19	12.7	120	1040H62 01	1040H62 02	1040H62 03	1040H62 04	9.450
5/8	23	15.9	140	1040H66 01	1040H66 02	1040H66 03	1040H66 04	13.000
3/4	27	19.1	170	1040H69 01	1040H69 02	1040H69 03	1040H69 04	16.500

Also available in 20 m length upon request

1080H Braided Self-Fastening NBR Hose






Drum 80 m

DN	O.D. (mm)	I.D. (mm)						kg
5/8	23	15.9	140	1080H66 01	1080H66 02	1080H66 03	1080H66 04	26.160
3/4	27	19.1	170	1080H69 01	1080H69 02	1080H69 03	1080H69 04	33.160

Also available in 20 m length upon request

1100H Braided Self-Fastening NBR Hose

Drum 100 m

DN	O.D. (mm)	I.D. (mm)						kg
1/4	13	6.3	60	1100H56 01	1100H56 02	1100H56 03	1100H56 04	14.660
3/8	16	9.5	70	1100H60 01	1100H60 02	1100H60 03	1100H60 04	20.600
1/2	19	12.7	120	1100H62 01	1100H62 02	1100H62 03	1100H62 04	23.000

Also available in 20 m length upon request

Related Products

Self-fastening hose is designed for use with Parker Legris brass barb connectors (CNOMO-certified).

Barb Connectors

- [0132](#) P. 5-25
- [0133 .. 39](#) P. 5-25
- [0134](#) P. 5-25



Installation Tool

Tool Part Number:
[0650 00 00 05](#)

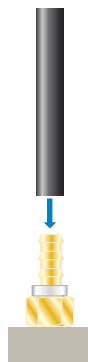
This automatic installation tool reduces the effort required to connect self-fastening hose onto a barb connector.



Tube Cutting and Positioning

Cut the tube at a right angle and position the barb connector on the mounting tool.

Barb connector support



Press-Fitting the Tube


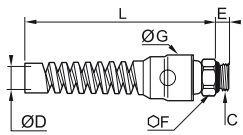

Activate the press-fit tool; connection is complete when the tube is fully home on the barb connector. This tool has been designed for use with 5 different diameters and is easy to operate.

Barb connector support


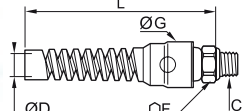



Accessories


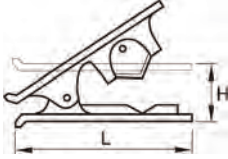
0694 Push-In Fitting with Protection Spring, Male BSPP Thread

	Nickel-plated brass, NBR 	ØD C 	E F G L kg
		8 G1/4 0694 08 13	6.5 16 24 104.5 0.067
		10 G1/4 0694 10 13	6.5 18 24 106.5 0.062
		12 G3/8 0694 12 17	7.5 20 29.5 126 0.080



0695 Push-In Fitting with Protection Spring, Male BSPT Thread

	Nickel-plated brass, NBR 	ØD C 	F G L kg
		8 R1/4 0695 08 13	14 24 104.5 0.055
		10 R1/4 0695 10 13	18 24 106.5 0.064
		12 R3/8 0695 12 17	20 29.5 126 0.090



3000 71 00 Tube Cutter

	Technical polymer 		H L kg
		3000 71 00	25 79 0.029 This tool is designed to give a clean cut at right angles to the tube axis for all resilient polymer tubing (polyamide, polyurethane, FEP, polyethylene, etc.) from 4 mm to 12 mm diameter inclusive. Replacement blades: part number 3000 71 00 05 A spring maintains the cutter in the closed position.


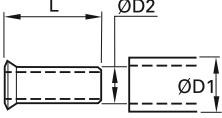

3000 71 11 Tube Cutter

	Treated steel		kg
		3000 71 11	0.227

6000 71 00 Stripping Tool for Anti-Spark Tubing


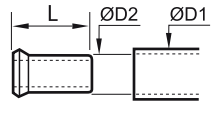

	Technical polymer, stainless steel		kg
		6000 71 00	0.098 Working principle of the stripping tool page 3-17

1827 Stainless Steel Tube Support for Fluoropolymer Tubing

	Stainless steel 316L 	ØD1	ØD2		L	kg
		6	4	1827 06 00	11.5	0.001
		8	6	1827 08 00	14	0.001
		10	8	1827 10 00	18	0.001
		12	9	1827 12 09	18	0.001
			10	1827 12 00	18	0.001
		16	14	1827 16 00	18	0.002


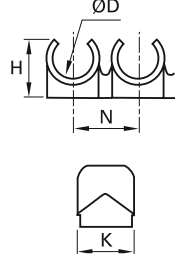

This tube support is necessary when using fluoropolymer FEP tubing at all temperatures compatible with the fitting/ tubing assembly.

0127 Brass Tube Support for Polymer Tubing

	Brass 	ØD1	ØD2		L	kg
		4	2	0127 04 00	11	0.001
			2.7	0127 04 27	11	0.001
		5	3	0127 05 03	11	0.001
			3.3	0127 05 00	11.5	0.009
		6	4	0127 06 00	11.5	0.001
			5.5	0127 08 55	14	0.001
		8	6	0127 08 00	14	0.001
			7	0127 10 07	18	0.001
		10	7.5	0127 10 75	18	0.001
			8	0127 10 00	18	0.002
			8	0127 12 08	18	0.002
		12	9	0127 12 09	18	0.002
			10	0127 12 00	18	0.001
		14	11	0127 14 11	18	0.002
			12	0127 14 00	18	0.002
		15	12	0127 15 12	18	0.002
		16	13	0127 16 13	18	0.003
		18	14	0127 18 14	19.5	0.003
		20	15	0127 20 15	20.5	0.003
22	16	0127 22 16	21	0.004		
25	19	0127 25 19	25	0.007		


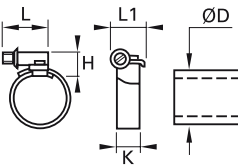

This tube support guarantees good gripping, at high temperatures and pressures, by preventing collapsing of the tube.

CLIP Clip Strip for Tubing and Fittings

	Technical polymer 	ØD		H	K	N	kg
		4	CLIP 04 00	9	13.5	10.5	0.007
		6	CLIP 06 00	10.5	13	10.5	0.004
		8	CLIP 08 00	12.5	10.5	12	0.007
		10	CLIP 10 00	14	12	15	0.005
		12	CLIP 12 00	16.5	14	16.5	0.009
		14	CLIP 14 00	18	16	20.5	0.008

Delivered in boxes of 10 strips of the same diameter (complete with self-tapping screws of 95 mm length)
These clips can be used with metric or inch tubing.

0697 Clip for Braided Tubing

	Treated steel 	ØD		H	K	L	L1	kg
		6-11	0697 00 01	7	5	12	7	0.004
		10-16	0697 00 02	12	9	21	13	0.011
		12-22	0697 00 03	12	9	21	13	0.015
		16-27	0697 00 04	12	9	24	13	0.015
20-32	0697 00 05	12	9	24	13	0.016		

Chemical Compatibility Chart

Recommended	1	Not Recommended	3
Satisfactory	2	Not Available	-

Substances	PA	PU ether	PU ester	Low Density PE	APE	FEP/PFA
Acetaldehyde	1	1	3	3	2	1
Acetone	1	3	1	2	1	1
Acetylene	-	-	-	3	-	1
Acid, chromic up to 10%	2	3	3	3	-	1
Acid, citric	1	1	1	1	1	1
Acid, formic up to 10%	-	-	-	3	-	1
Acid, hydrochloric up to 10%	3	1	3	1	1	1
Acid, phosphoric up to 50%		3	3	1	1	1
Acid, sulphuric up to 10%	3	1	1	1	1	1
Acid, acetic	3	1	3	1	1	1
Acid, nitric	2	1	3	2	-	1
Ammonia and gaseous	-	1	3	2	1	1
Ammonium chloride up to 10%	-	1	1	1	1	1
Benzene	1	3	3	3	2	1
Bromine	3	-	-	2	3	1
Butane	-	1	1		1	1
Butyl acetate	1	3	2	2		1
Butylic and butyl alcohol	1	3	2	1	1	1
Calcium choride	1	-	-	2	1	1
Carbon tetrachloride (sodium hypochlorite)	2	2	2		3	1
Chloroform	3	3	3	2	2	1
Compressed air	-	1	1	1	1	1
Copper sulphate	-	-	-	-	-	1
Cyclohexanone	1	3	3	3		1
Ethanol	1	2	2			1
Ethyl acetate	1	2	2	1	1	1
Ethyl alcohol	1	-	-	2	1	1
Ethylene oxide	-	-	-	3	2	1
Formalin (formaldehyde)	1	1	2	1	1	1
Freon 12-22	2	2	2	-	-	1
Glucose	-	1	2	1	1	1
Glycol (methyl)	-	3	3	-	-	1
Glycol (without H ₂ O)	-	1	1	1	1	1
Hexachloride	-	2	1	-	-	1
Hydrogen	1	1	2	-	1	1
Hydrogen peroxide (perydrol)	3	2	2	-	1	1
Kerosene	1	1	2	-	3	1
Magnesium chloride (up to 30%)	1	1	2	-	1	1
Methane	1	1	1	-	-	1
Methanol	2	1	1	-	-	1
Methyl acetate	-	2	2	-	-	1
Methyl alcohol (pure)	1	1	1	-	2	1

Chemical Compatibility Chart

Substances	PA	PU ether	PU ester	LDPE	APE	FEP/PFA
Methyl bromide	2	-	-	-	-	1
Methyl chloride	2	-	-	-	-	1
Methyl ethyl ketone	1	3	3	-	-	1
Methyl isobutyl ketone	1	3	3	-	-	1
Oils (ASTM class A)	1	1	1	-	-	1
Oils (ASTM class B)	1	2	1	-	-	1
Oils (ASTM class C)	1	2	1	-	-	1
Oils (ASTM class 1)	1	1	1	-	-	1
Oils (ASTM class 2)	1	1	1	-	-	1
Oils (ASTM class 3)	1	1	1	-	-	1
Oils (cutting)	1	1	1	-	3	1
Oils (paraffin)	1	1	2	-	-	1
Oils, engine (diesel)	1	2	2	2	2	1
Oxygen	1	1	1	1	1	1
Ozone	3	2	2	-	3	1
Perchlorate ethylene	1	3	3	-	-	1
Petrol, with up to 40% aromatics	3	3	2	-	3	1
Petrol, with more than 40% aromatics	1	3	3	-	3	1
Phenols	1	3	3	-	-	1
Potash	1	2	3	-	-	1
Potassium chloride up to 40%	-	1	2	-	-	1
Potassium hydroxide	1	-	-	-	1	1
Potassium manganate 5%	1	3	2	-	1	1
Potassium sulphate	1	-	-	-	-	1
Propane	1	1	1	-	-	1
Soda 50%	1	1	3	-	1	1
Sodium carbonate	1	-	-	-	1	1
Sodium chloride	-	1	2	-	-	1
Sodium hydroxide (caustic soda)	-	1	2	-	1	1
Sodium hypochlorite (bleach)	1	1	3	-	-	1
Sulphurous anhydride	1	-	-	-	-	1
Tetrachloroethylene	1	2	2	-	-	1
Toluene	1	2	2	3	3	1
Tributylphosphate	1	-	-	-	-	1
Trichlorethylene	1	3	3	-	-	1
Water (distilled, deionised)	-	1	3	2	1	1
Water (drinking, food)	1	1	3	1	1	1
Water (industrial)	1	1	3	1	1	1
Water (sea)	2	1	3	1	1	1
Xylem	1	2	2	-	-	1
Zinc chloride	1	1	1	-	-	1

For other fluids, concentrations or special implementation, please contact us.

Function Fittings

Flow Control Regulators

Piloted Function Fittings

Non-Return Valves

LIQUIfit®

Pressure Fittings

Other Function Fittings

Silencers



PARKER LEGRIS Industrial Connector Systems

Products are available from:

MARYLAND METRICS

P.O. Box 261 Owings Mills, MD 21117 USA email: sales@mdmetric.com

ph: (410)358-3130 (800)638-1830 fx: (410)358-3142 (800)872-9329

web: http://mdmetric.com RFQ form: http://mdmetric.com/rfq.htm

How to order: Please preface each PARKER LEGRIS Catalog part number with 'R053-' Example: R053-3175 04 10



Function Fittings

Flow Control Regulators

[P. 4-6]



Function: controls the speed of the cylinder rod
Materials: polymer, metal, stainless steel
Pressure: 10 bar
Temperature: 0°C to +70°C
Ø metric: 3 mm to 18 mm
Threads: BSPP, BSPT, metric

Blocking Fittings

[P. 4-36]



Function: provides safety by locking the cylinder piston
Materials: nickel-plated brass, polymer
Pressure: 10 bar
Temperature: -20°C to +70°C
Ø metric: 6 mm to 12 mm
Threads: BSPP, BSPT

Piloted Non-Return Valves

[P. 4-38]



Function: provides safety by locking the cylinder piston
Materials: nickel-plated brass, polymer
Pressure: 10 bar
Temperature: -5°C to +60°C
Ø metric: 6 mm to 12 mm
Threads: BSPP

Non-Return Valves

[P. 4-40]



Function: allows air to pass in one direction only
Materials: polymer, nickel-plated brass
Pressure: 10 bar
Temperature: 0°C to +70°C
Ø metric: 4 mm to 12 mm
Threads: BSPP, BSPT, metric

Adjustable Non-Return Valves

[P. 4-42]



Function: allows air to pass in one direction with an adjustable opening pressure
Materials: FDA chemical nickel-plated brass
Pressure: 12 bar
Temperature: -20°C to +80°C
Threads: BSPP, metric

LIQUIfit® Non-Return Valves

[P. 4-44]



Function: allows fluid to pass in one direction only
Materials: polymer for food applications
Pressure: 10 bar
Temperature: 0°C to +65°C
Ø inch: 1/4" and 3/8"

Stainless Steel Non-Return Valves

[P. 4-46]



Function: allows fluid to pass in one direction only
Materials: stainless steel
Pressure: 0.5 to 40 bar
Temperature: -20°C to +180°C
DN : 10 mm to 25 mm
Threads: BSPP, NPT

Soft Start Fittings

[P. 4-48]



Function: protects the installation at start-up
Materials: polymer, nickel-plated brass
Pressure: 3 to 10 bar
Temperature: -15°C to +60°C
Ø metric : 8 mm to 12 mm
Threads: BSPP

Pneumatic Sensor Fittings

[P. 4-50]



Function: pneumatic or electric output signal, detects end of cylinder rod stroke
Materials: polymer, treated metal
Pressure: 3 to 8 bar
Temperature: -15°C to +60°C
Ø metric: 4 mm
Threads: BSPP, metric

Function Fittings

Pressure Regulators/Pressure Reducers (P. 4-52)



Function: limits the maximum pressure delivered to pneumatic equipment

Materials: polymer, treated metal

Pressure: 16 bar (upstream), 8 bar (downstream)

Temperature: -15°C to +70°C

Ø metric: 4 mm to 10 mm

Threads: BSPP

Snap Connectors (P. 4-56)



Function: isolates a circuit without venting the whole system

Materials: polymer, nickel-plated brass

Pressure: 10 bar

Temperature: -20°C to +80°C

Ø metric: 5 mm to 7 mm

Threads: BSPP

Manually-Operated Valves (P. 4-58)



Function: opens/closes a circuit, with or without venting

Materials: polymer, nickel-plated brass, aluminium

Pressure: 16 bar, 10 bar

Temperature: -10°C to +80°C

Ø metric: 4 mm to 10 mm

Threads: BSPP, metric

Metal Quick Exhaust Valves (P. 4-60)



Function: increases the return speed of the cylinder

Materials: nickel-plated brass, aluminium, stainless steel

Pressure: 10 bar

Temperature: -20°C to +70°C

Threads: BSPP, BSPT, metric

Silencers (P. 4-62)



Function: reduces noise levels

Materials: sintered bronze, polyethylene, stainless steel, nickel-plated brass

Pressure: 12 bar

Temperature: -20°C to +180°C

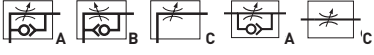



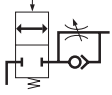
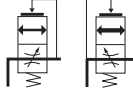





Ø metric: 4 mm to 12 mm

Threads: BSPP, metric, NPT

Selecting Your Function Fitting

Protect Your System	Blocking Fittings	Maintain the load following an emergency stop of a pneumatic system.	Models 7880 - 7881 - 7883 - 7885 7886
	Soft Start Fittings	Increase the pressure gradually in order to protect it from potentially damaging shock when a pneumatic system is restarted.	Models 7860 - 7861 - 7870 - 7871
	Non-Return Valves	Allow compressed air to flow in one direction, and prevent it from flowing in the other. If the supply is accidentally shut off, the air can only escape in one direction.	Models 4890 - 4891 - 4892 - 4895 7930 - 7931 - 7932 - 7984 7985 - 7992 - 7994 - 7995 7996
	Piloted Non-Return Valves	Incorporate 3 functions into one product to protect your system: piloted non-return valve, flow control regulator and manual vent.	Models 7892 - 7894
Detect End of Cylinder Rod Stroke	Pneumatic Sensor Fittings	Detect the back pressure drop at the end of stroke to produce a signal (pneumatic or electronic) to allow reciprocation.	Models 7818 - 7828
Control and Improve the Performance of Your System	Pressure Regulators	Regulate and stabilise the pressure at a maximum determined value whatever the upstream pressure.	Models 7300
	Pressure Reducer Fittings	Reduce the pressure consumed in one section of the machine in order to save energy.	Models 7316 - 7318 - 7416 - 7471
	Quick Exhaust Valves	Increase the return speed of the cylinder by discharging the exhaust directly to atmosphere.	Models 7899 - 7970 - 7971
	Silencers	Reduce the noise levels whilst air is vented from a compressed air system.	Models 0670 - 0671 - 0672 - 0673 0674 - 0675 - 0676 - 0677
Working on Your System	Snap Fittings	Allow a circuit to be isolated without fully venting the system.	Models 7921 - 7926 - 7960 - 7961
	Manually-Operated Valves	Allow for repeated venting by simply moving the valve sleeve or the manually-operated valve lever.	Models 0669 - 7800 - 7801 - 7802

Symbols for Function Fittings

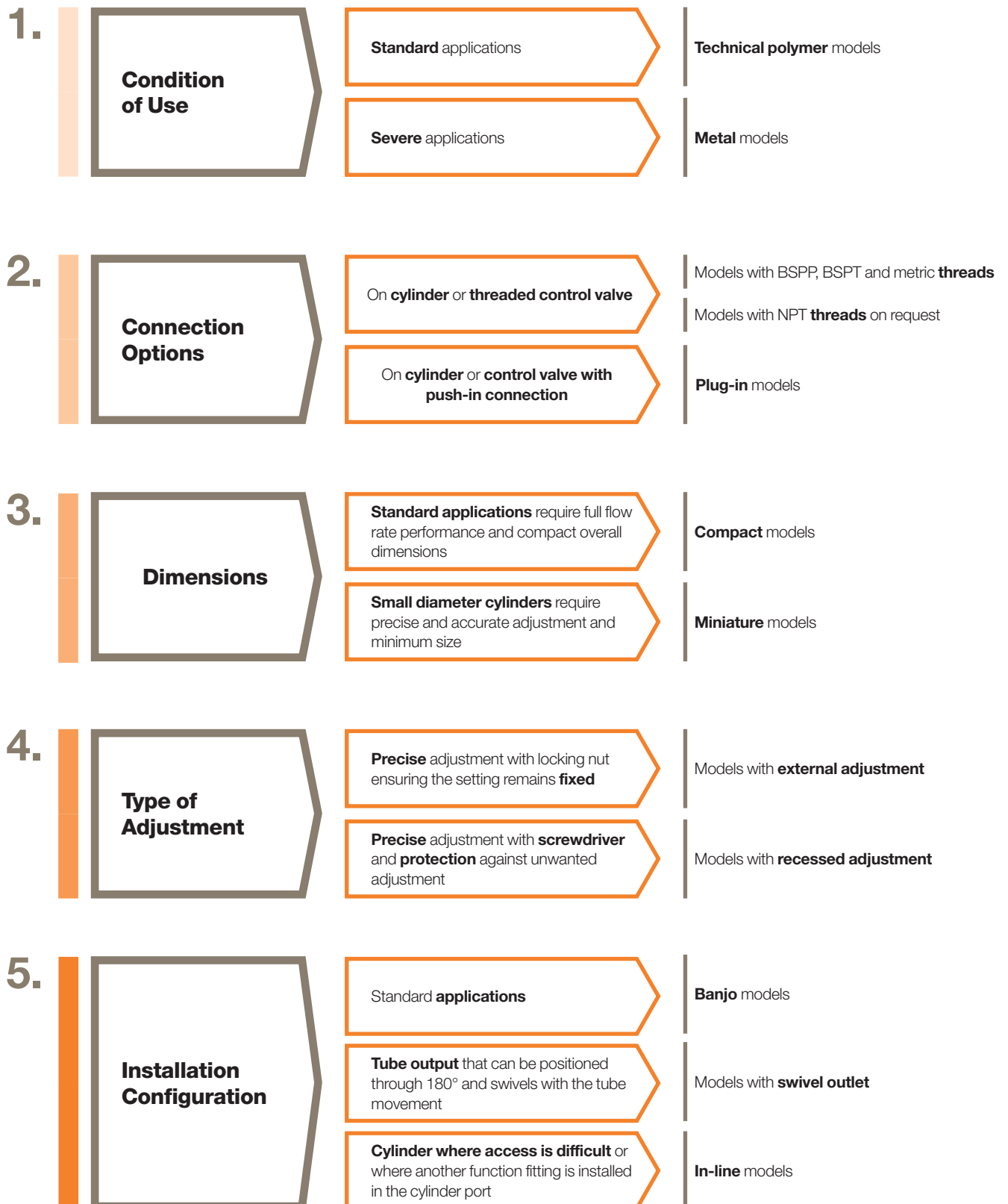
<p>Regulating air flow</p> 	<p>Regulating pressure by stabilising at a required value</p> 
<p>Blocking air circulation</p> 	<p>Reducing pressure supply</p> 
<p>Blocking and regulating air flow</p> 	<p>Progressive pressurising of circuits</p> 
<p>Controlling allows the passage of fluid in one direction and prevents it in the other</p> 	<p>Isolating a circuit without venting the entire system</p> 
<p>Exhausting system and controlling pneumatic circuit supply</p> 	<p>Regulating, blocking and venting to protect the system and individuals</p> 
<p>Detecting pressure drop</p> 	

Selecting Your Flow Control Regulator

The comprehensive range of Parker Legris flow control regulators provides a solution for all flow regulation functions in a pneumatic system.

Select the model suited to your application according to:

5 Key Requirements



Flow Control Regulator Range

Technical Polymer Version, BSPP and Metric

Recessed Adjustment

7010
7011
7012
Push-In
Page 4-10



External Adjustment

7060
7061
7062
Compact
Push-In
Page 4-11/12



7660
7662
7669
Miniature
Push-In
Page 4-13/14



Swivel Outlet

7040
7041
Compact
Push-In
Page 4-14



7640
7649
Miniature
Push-In
Page 4-15



In-Line

7770
7772
Push-In
Page 4-16



7776
Bulkhead
Push-In
Page 4-16



7771
Threaded
Page 4-16



7020
Straight
Push-In
Page 4-17



7000
Page 4-16



Plug-In

7030
7031
Compact
Push-In
Page 4-18



7630
7631
Miniature
Push-In
Page 4-18



Technical Polymer Version, BSPT

External Adjustment

7065
7066
7067
Compact
Push-In
Page 4-11/12



7665
7668
Miniature
Push-In
Page 4-13



Swivel Outlet and External Adjustment

7045
Compact
Push-In
Page 4-14



7645
Miniature
Push-In
Page 4-15



Brass, Nickel-Plated Brass and Aluminium Versions, BSPP and Metric

Recessed Adjustment

7130
Push-In
Page 4-19



7140
Threaded
Page 4-19



7160
Compression
Page 4-19



In-Line

7170
Bulkhead
Threaded
Page 4-21



External Adjustment

7762
Threaded
Page 4-21



7100
7101
Compact
Push-In
Page 4-20



7680
Compact
Push-In
Page 4-20



7180
Miniature
Push-In
Page 4-20



7110
7111
Compact
Threaded
Page 4-20/21



7190
Miniature
Threaded
Page 4-21



Stainless Steel Versions

7810
7812
Threaded
Page 4-23



7820
7822
Threaded
Page 4-23



Flow Control Regulators

Parker Legris flow control regulators with polymer, nickel-plated brass or aluminium bodies, external or recessed adjustment screws, offer **precise adjustment, accuracy** and **compactness** providing the solution for all applications.

Product Advantages

Improved Productivity

- Higher maximum flow than standard regulators
- Full flow with minimum pressure drop (model 7060)
- Optimal control of the cylinder rod speed
- 100% leak-tested in production
- Date coding to guarantee quality and traceability
- Reduce compressed air and energy consumption

Accuracy & Performance

- Precise adjustment for accurate flow regulation from initial to maximum opening
- Constant cylinder rod displacement speed
- Long-term stability of flow
- Reduced weight (polymer version)
- Mechanical strength and corrosion resistance with nickel-plated brass version

Ergonomics & Large Range

- External adjustment screw: easy to adjust without tooling and lockable
- Recessed adjustment screw: more compact and protects the adjustment mechanism
- Uni-directional: exhaust or inlet
- Bi-directional: adjustment of air flow in both directions
- 360° positioning
- NPT version on request



- Applications**
- Pneumatics
 - Robotics
 - Semi-Conductors
 - Textile
 - Automotive Process
 - Packaging

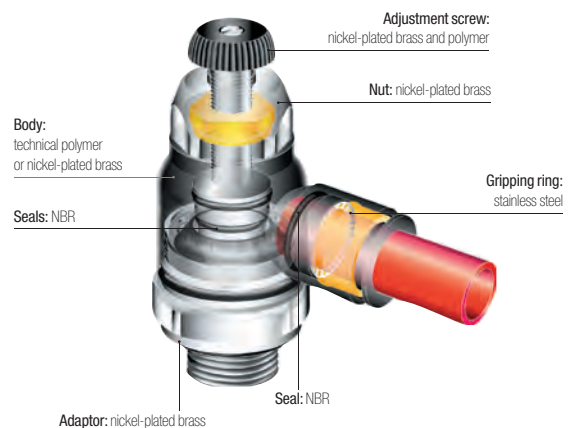
Technical Characteristics

Compatible Fluids	Compressed air Other fluids: contact us
Working Pressure	1 to 10 bar
Working Temperature	0°C to +70°C

Max. Tightening Torques (external adjustment screw)	Threads	M3 x0.5	M5 x0.8	G1/8	G1/4	G3/8	G1/2
	daN.m	0.06	0.16	0.8	1.2	3	3.5
Max. Tightening Torques (recessed adjustment screw)	Threads	-	M5 x0.8	G1/8	G1/4	G3/8	G1/2
	daN.m	-	0.1	0.4	0.5	0.6	0.7

You will find all the flow rate characteristic curves (to 6 bar) for flow control regulators at the end of the chapter.

Component Materials



Silicone-free

Flow Control Regulators

Operation

Parker Legris offers both uni-directional and bi-directional flow control regulators.

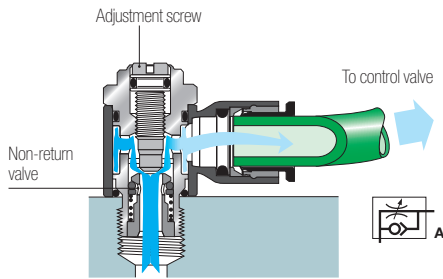
The uni-directional models control the flow of air in one direction through an adjustable restrictor, while allowing full flow in the opposite direction.

The bi-directional models control the flow of air in both directions.

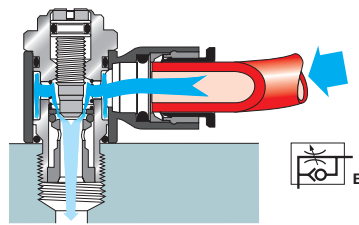
A more precise and constant flow regulation is obtained when the regulator is fitted directly onto the cylinder.

Models with Recessed Adjustment

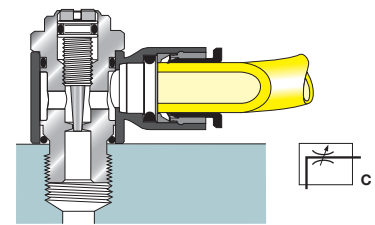
Uni-Directional (Exhaust Version)



Uni-Directional (Supply Version)

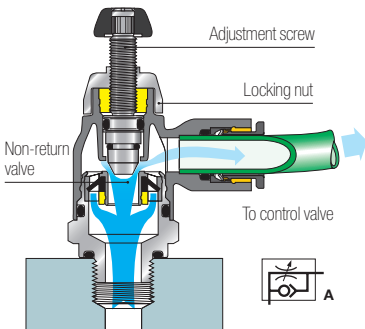


Bi-Directional Version

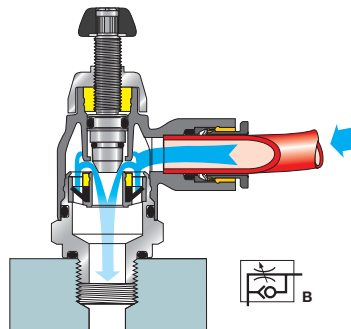


Models with External Adjustment

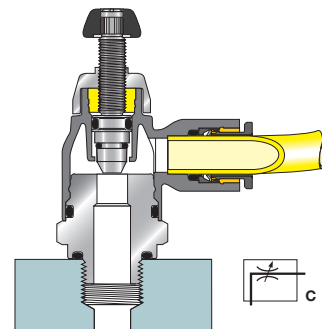
Uni-Directional (Exhaust Version)



Uni-Directional (Supply Version)

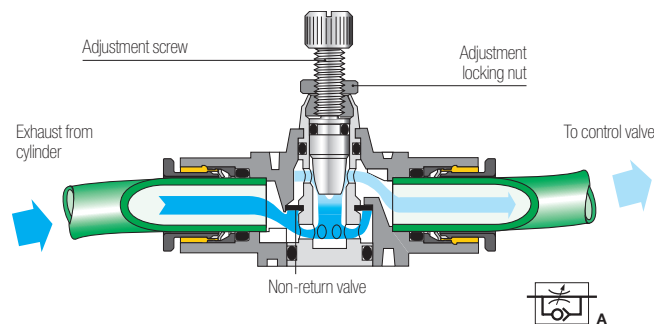


Bi-Directional Version

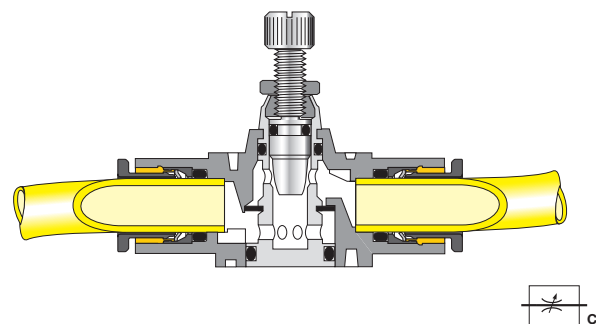


In-Line Models

Uni-Directional Version



Bi-Directional Version



For instant visual identification, each Parker Legris flow control regulator version is identified by the related pneumatic symbol and by a letter:

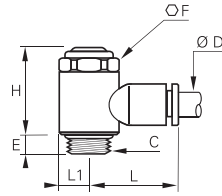
- uni-directional regulation on exhaust: letter A
- uni-directional regulation on supply: letter B
- bi-directional regulation: letter C

Regulators with Recessed Adjustment

7010 Flow Regulator with Recessed Adjustment Screw Exhaust, Male BSPP and Metric Thread



Technical polymer, nickel-plated brass, NBR

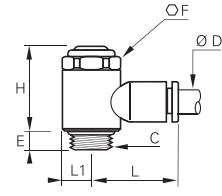


ØD	C		E	F	H	L	L1	kg
4	M5x0.8	7010 04 19	4	8	17.5	17	5	0.006
	G1/8	7010 04 10	5	13	25	19	7	0.018
	M5x0.8	7010 06 19	4	8	17.5	19	5	0.006
6	G1/8	7010 06 10	5	13	25	21	7	0.018
	G1/4	7010 06 13	8	17	26.5	22	9.5	0.034
8	G1/8	7010 08 10	5	13	25	26	7	0.019
	G1/4	7010 08 13	8	17	26.5	27	9.5	0.035
	G3/8	7010 08 17	7.5	20	37.5	29	11	0.068
10	G1/4	7010 10 13	8	17	26.5	29	9.5	0.035
	G3/8	7010 10 17	7.5	20	37.5	31	11	0.067
12	G1/2	7010 10 21	8	23	43	37	13.5	0.118
	G3/8	7010 12 17	7.5	20	37.5	34.5	11	0.069
	G1/2	7010 12 21	8	23	43	37	13.5	0.108

7011 Flow Regulator with Recessed Adjustment Screw Supply, Male BSPP and Metric Thread



Technical polymer, nickel-plated brass, NBR

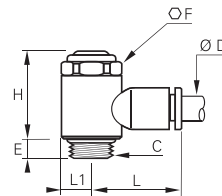


ØD	C		E	F	H	L	L1	kg
4	M5x0.8	7011 04 19	4	8	17.5	17	5	0.006
	G1/8	7011 04 10	5	13	25	19	7	0.018
	M5x0.8	7011 06 19	4	8	17.5	19	5	0.006
6	G1/8	7011 06 10	5	13	25	21	7	0.018
	G1/4	7011 06 13	8	17	26.5	22	9.5	0.034
8	G1/8	7011 08 10	5	13	25	26	7	0.019
	G1/4	7011 08 13	8	17	26.5	27	9.5	0.034
	G3/8	7011 08 17	7.5	20	37.5	29	11	0.067
10	G1/4	7011 10 13	8	17	26.5	29	9.5	0.036
	G3/8	7011 10 17	7.5	20	37.5	31	11	0.068

7012 Bi-Directional Flow Regulator with Recessed Adjustment Screw, Male BSPP and Metric Thread



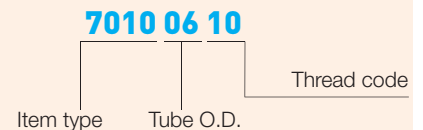
Technical polymer, nickel-plated brass, NBR



ØD	C		E	F	H	L	L1	kg
4	M5x0.8	7012 04 19	4	8	17.5	17	5	0.006
	G1/8	7012 04 10	5	13	25	19	7	0.018
	M5x0.8	7012 06 19	4	8	17.5	19	5	0.007
6	G1/8	7012 06 10	5	13	25	21	7	0.019
	G1/4	7012 06 13	8	17	26.5	22	9.5	0.036
8	G1/8	7012 08 10	5	13	25	26	7	0.020
	G1/4	7012 08 13	8	17	26.5	27	9.5	0.036
	G3/8	7012 08 17	7.5	20	37.5	29	11	0.070

Each pneumatic function fitting is identified by:

- the item type
- the tube outside diameter
- the thread or 2nd tube outside diameter

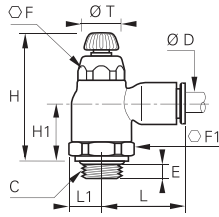


Compact Regulators with External Adjustment

7060 Compact Flow Regulator Exhaust, Male BSPP Thread



Technical polymer, nickel-plated brass, NBR

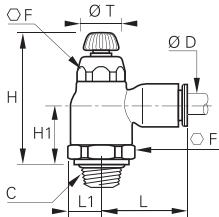


ØD	C		E	F	F1	H	H _{max}	H1	L	L1	ØT	kg
4	G1/8	7060 04 10	5	10	16	38	44	16	22	9	10	0.020
	G1/8	7060 06 10	5	10	16	38	44	16	22	9	10	0.020
6	G1/4	7060 06 13	5.5	10	16	36.5	42.5	15	22	9	10	0.020
	G1/8	7060 08 10	4.5	14	19	41.5	48	18	28	10.5	14	0.033
8	G1/4	7060 08 13	5.5	14	19	41.5	48	18.5	28	10.5	14	0.034
	G3/8	7060 08 17	5.5	14	19	41.5	48	17	28	11	14	0.034
10	G1/4	7060 10 13	5.5	17	23	45.5	53.5	20	31.5	12.5	17	0.053
	G3/8	7060 10 17	5.5	17	23	45.5	54	20	31.5	12.5	17	0.054
12	G3/8	7060 12 17	5.5	17	23	45.5	54	20	35	12.5	17	0.060
	G1/2	7060 12 21	7.5	17	24	45.5	54	20	35	13	17	0.058

7065 Compact Flow Regulator Exhaust, Male BSPT Thread



Technical polymer, nickel-plated brass, NBR



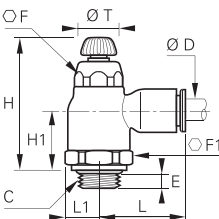
ØD	C		F	F1	H _{min}	H _{max}	H1	L	L1	ØT	kg
6	R1/8	7065 06 10	10	16	36.5	42.5	15	22	8	10	0.021
	R1/8	7065 08 10	14	19	40	45	16.5	28	10.5	14	0.034
8	R1/4	7065 08 13	14	19	40	45	16.5	28	10.5	14	0.036
	R1/4	7065 10 13	17	23	43.5	51.5	18	31.5	12.5	17	0.053
10	R3/8	7065 10 17	17	23	43.5	51.5	18	31.5	12.5	17	0.055
	R1/2	7065 10 21	17	23	43.5	51.5	18	31.5	12.5	17	0.059
12	R1/4	7065 12 13	17	23	43.5	51.5	18	35	12.5	17	0.056
	R3/8	7065 12 17	17	23	43.5	51.5	18	35	12.5	17	0.059
	R1/2	7065 12 21	17	23	43.5	51.5	18	35	12.5	17	0.064

Pre-coated thread

7061 Compact Flow Regulator Supply, Male BSPP Thread



Technical polymer, nickel-plated brass, NBR

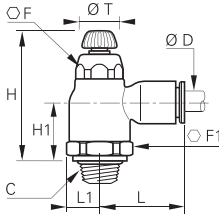


ØD	C		E	F	F1	H	H _{max}	H1	L	L1	ØT	kg
4	G1/8	7061 04 10	5	10	16	38	44	16	22	9	10	0.020
	G1/8	7061 06 10	5	10	16	38	44	16	22	9	10	0.020
6	G1/4	7061 06 13	5.5	10	16	36.5	42.5	15	22	9	10	0.021
	G1/8	7061 08 10	4.5	14	19	41.5	48	18	28	10.5	14	0.033
8	G1/4	7061 08 13	5.5	14	19	41.5	48	18.5	28	10.5	14	0.034
	G3/8	7061 08 17	5.5	14	23	41.5	48	17	28	11	14	0.033
10	G1/4	7061 10 13	5.5	17	23	45.5	53.5	20	31.5	12.5	17	0.053
	G3/8	7061 10 17	5.5	17	23	45.5	54	20	31.5	12.5	17	0.054
12	G1/2	7061 12 21	7.5	17	24	45.5	54	20	35	13	17	0.060

7066 Compact Flow Regulator Supply, Male BSPT Thread



Technical polymer, nickel-plated brass, NBR



ØD	C		F	F1	H _{min}	H _{max}	H1	L	L1	ØT	kg
	R1/4	7066 10 13	17	23	43.5	51.5	18	31.5	12.5	17	0.020
10	R3/8	7066 10 17	17	23	43.5	51.5	18	31.5	12.5	17	0.020
	R1/2	7066 10 21	17	23	43.5	51.5	18	31.5	12.5	17	0.059
	R1/4	7066 12 13	17	23	43.5	51.5	18	35	12.5	17	0.056
12	R3/8	7066 12 17	17	23	43.5	51.5	18	35	12.5	17	0.059
	R1/2	7066 12 21	17	23	43.5	51.5	18	35	12.5	17	0.064

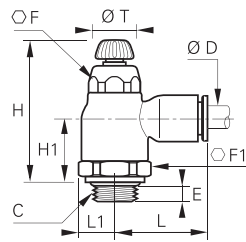
Pre-coated thread

Compact Regulators with External Adjustment

7062 Bi-Directional Compact Flow Regulator, Male BSPP Thread



Technical polymer, nickel-plated brass, NBR

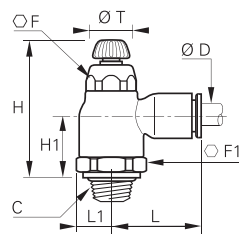


ØD	C		E	F	F1	H	H _{max}	H1	L	L1	ØT	kg
4	G1/8	7062 04 10	5	10	16	38	44	16	22	9	10	0.025
6	G1/8	7062 06 10	5	10	16	38	44	16	22	9	10	0.025
	G1/4	7062 06 13	5.5	10	16	36.5	42.5	15	22	9	10	0.025
8	G1/8	7062 08 10	4.5	14	19	41.5	48	18	28	10.5	14	0.043
	G3/8	7062 08 17	5.5	14	19	41.5	48	18.5	28	10.5	14	0.046

7067 Bi-Directional Compact Flow Regulator, Male BSPT Thread



Technical polymer, nickel-plated brass, NBR



ØD	C		F	F1	H _{min}	H _{max}	H1	L	L1	ØT	kg
4	R1/8	7067 04 10	10	16	36.5	42.5	14.7	22	9	10	0.025
6	R1/8	7067 06 10	10	16	36.5	42.5	14.7	22	9	10	0.010
	R1/4	7067 06 13	10	16	36.5	42.5	14.7	22	9	10	0.014
8	R1/8	7067 08 10	14	19	40	45	16.5	28	10.5	14	0.034
	R1/4	7067 08 13	14	19	40	45	16.5	28	10.5	14	0.036
	R3/8	7067 08 17	14	19	40	45	16.5	28	11	14	0.042

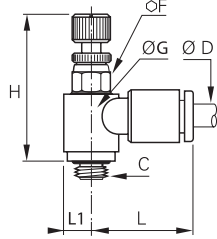
Pre-coated thread

Miniature Regulators with External Adjustment

7660 Miniature Flow Regulator Exhaust, Male BSPP and Metric Thread



Technical polymer, nickel-plated brass, NBR

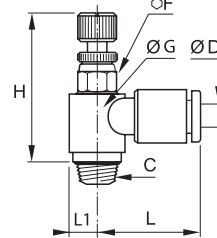


ØD	C		F	G	H _{min}	H _{max}	L	L1	kg
3	M3x0.5	7660 03 09	6	9	23.5	26	17	4.5	0.007
	M5x0.8	7660 03 19	6	9	23.5	26	17	4.5	0.006
4	M3x0.5	7660 04 09	6	9	23.5	26	16.5	4.5	0.007
	M5x0.8	7660 04 19	6	9	23.5	26	17	4.5	0.006
6	G1/8	7660 04 10	7	11.5	27	29.5	18	6	0.012
	M5x0.8	7660 06 19	6	9	23.5	26	18	4.5	0.007
	G1/8	7660 06 10	7	11.5	27	29.5	18.5	6	0.012
8	G1/4	7660 06 13	8	12	30	32.5	19	6	0.019
	G1/8	7660 08 10	13	14	26.5	31	26	7	0.021
	G1/8	7660 08 13	16	19	29	34	27.5	9.5	0.033
	G3/8	7660 08 17	20	23	36	42	29	11.5	0.062

7665 Miniature Flow Regulator Exhaust, Male BSPT Thread



Technical polymer, nickel-plated brass, NBR



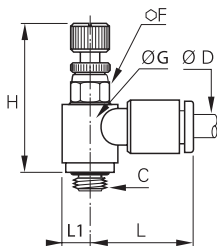
ØD	C		F	G	H _{min}	H _{max}	L	L1	kg
4	R1/8	7665 04 10	7	11.5	25	27.5	18	6	0.012
	R1/8	7665 06 10	7	11.5	25	27.5	18.5	6	0.012
6	R1/4	7665 06 13	8	13.5	27.5	30	19	7	0.019
	R3/8	7665 06 17	17	13.5	31.5	34	19	7	0.025
8	R1/8	7665 08 10	13	14	24	28.5	26	7	0.021
	R1/4	7665 08 13	16	19	25	29	27.5	9.5	0.033
	R3/8	7665 08 17	20	23	30	36	29	11.5	0.061

Pre-coated thread

7669 Miniature Flow Regulator Supply, Male BSPP and Metric Thread



Technical polymer, nickel-plated brass, NBR

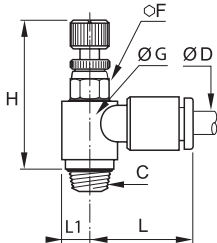


ØD	C		F	G	H _{min}	H _{max}	L	L1	kg
3	M3x0.5	7669 03 09	6	9	23.5	26	17	4.5	0.008
	M5x0.8	7669 03 19	6	9	23.5	26	17	4.5	0.007
4	M5x0.8	7669 04 19	6	9	23.5	26	17	4.5	0.006
	G1/8	7669 04 10	7	11.5	27	29.5	18	6	0.012
6	M5x0.8	7669 06 19	6	9	23.5	26	18	4.5	0.007
	G1/8	7669 06 10	7	11.5	27	29.5	18.5	6	0.013
	G1/4	7669 06 13	8	12	30	32.5	19	6	0.019
8	G1/8	7669 08 10	13	14	26.5	31	26	7	0.021
	G1/4	7669 08 13	16	19	29	34	27.5	9.5	0.033
	G3/8	7669 08 17	20	23	36	42	29	11.5	0.063

7668 Miniature Flow Regulator Supply, Male BSPT Thread



Technical polymer, nickel-plated brass, NBR



ØD	C		F	G	H _{min}	H _{max}	L	L1	kg
4	R1/8	7668 04 10	7	11.5	25	27.5	18	6	0.011
	R1/8	7668 06 10	7	11.5	25	27.5	18.5	6	0.012
6	R1/4	7668 06 13	8	13.5	27.5	30	19	7	0.019
	R1/8	7668 08 10	13	14	24	28.5	26	7	0.020
8	R1/4	7668 08 13	16	19	25	29	27.5	9.5	0.032
	R3/8	7668 08 17	20	23	30	36	29	11.5	0.061

Pre-coated thread

Flow Control Regulators

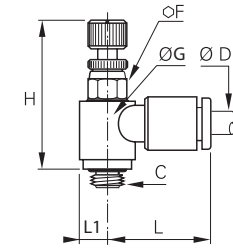
Function Fittings

Regulators with External Adjustment

7662 Bi-Directional Miniature Flow Regulator, Male BSPP and Metric Thread



Technical polymer, nickel-plated brass, NBR

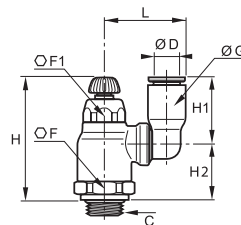


ØD	C		F	G	H _{min}	H _{max}	L	L1	kg
4	M5x0.8	7662 04 19	6	9	23.5	26	17	4.5	0.007
	G1/8	7662 04 10	7	11.5	27	29.5	18	6	0.013
6	M5x0.8	7662 06 19	6	9	23.5	26	18	4.5	0.010
	G1/8	7662 06 10	7	11.5	27	29.5	18.5	6	0.013
	G1/4	7662 06 13	8	12	30	32.5	19	6	0.019

7040 Compact Flow Regulator Swivel Outlet Exhaust, Male BSPP Thread



Technical polymer, nickel-plated brass, NBR

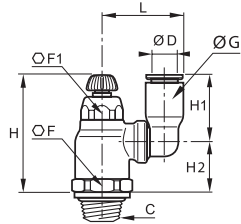


ØD	C		F	F1	G	H _{min}	H _{max}	H1	H2	L	kg
6	G1/8	7040 06 10	16	10	10.5	38	44	16	18	23.5	0.024
	G1/4	7040 06 13	16	10	10.5	36.5	42.5	16	16.5	23.5	0.025
8	G1/8	7040 08 10	19	14	13.5	41.5	48	23	19	28	0.037
	G1/4	7040 08 13	19	14	13.5	41.5	48	23	19.5	28	0.039
10	G3/8	7040 08 17	19	14	13.5	41.5	48	23	17.5	28	0.020
	G1/4	7040 10 13	23	17	16	45.5	53.5	26.5	21	35	0.051
12	G3/8	7040 10 17	23	17	16	45.5	54	26.5	21.5	35	0.063
	G3/8	7040 12 17	23	17	19	45.5	54	30.5	21.5	38	0.066
	G1/2	7040 12 21	24	17	19	45.5	54	30.5	21	38	0.071

7045 Compact Flow Regulator Swivel Outlet Exhaust, Male BSPT Thread



Technical polymer, nickel-plated brass, NBR



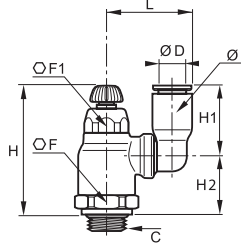
ØD	C		F	F1	G	H _{min}	H _{max}	H1	H2	L	kg
6	R1/4	7045 06 13	16	10	10.5	36.5	42.5	16	16.5	23.5	0.030
	R1/8	7045 08 10	19	14	13.5	40	46	23	17	28	0.014
8	R1/4	7045 08 13	19	14	13.5	40	46	23	17	28	0.043
	R3/8	7045 08 17	19	14	13.5	40	46	23	17	28	0.044
10	R1/4	7045 10 13	23	17	16	43.5	51.5	26.5	19	35	0.062
	R3/8	7045 10 17	23	17	16	43.5	51.5	26.5	19	35	0.065
12	R3/8	7045 12 17	23	17	19	43.5	51.5	31	19	38	0.065
	R1/2	7045 12 21	23	17	19	43.5	51.5	31	19	38	0.070

Pre-coated thread

7041 Compact Flow Regulator Swivel Outlet Supply, Male BSPP Thread




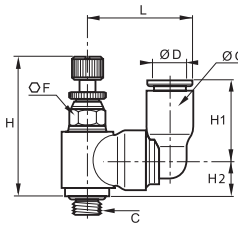

Technical polymer, nickel-plated brass, NBR




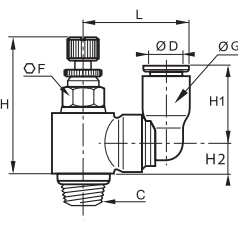

ØD	C		F	F1	G	H _{min}	H _{max}	H1	H2	L	kg
6	G1/4	7041 06 13	16	10	10.5	36.5	42.5	16	16.5	23.5	0.024
8	G1/8	7041 08 10	19	14	13.5	41.5	48	23	19	28	0.037
	G1/4	7041 08 13	19	14	13.5	41.5	48	23	19.5	28	0.039

Miniature Regulators with Swivel Outlet and External Adjustment


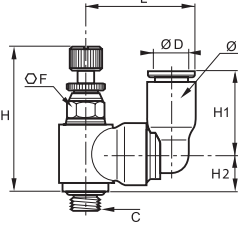

7640 Miniature Swivel Outlet Flow Regulator Exhaust, Male BSPP and Metric Thread

		Technical polymer, nickel-plated brass, NBR	ØD C  F G H _{min} H _{max} H1 H2 L kg
			4 M5x0.8 7640 04 19 6 8.5 23.5 26 14 6.5 19.5 0.011
			4 G1/8 7640 04 10 7 8.5 27 29.5 14 8 19.5 0.015
			6 M5x0.8 7640 06 19 6 10.5 23.5 26 16 6.5 21 0.001
			6 G1/8 7640 06 10 7 10.5 27 29.5 16 8 20.5 0.015

7645 Miniature Swivel Outlet Flow Regulator Exhaust, Male BSPT Thread

		Technical polymer, nickel-plated brass, NBR	ØD C  F G H _{min} H _{max} H1 H2 J L kg
			4 R1/8 7645 04 10 7 8.5 25 27.5 14 6 11.5 19.5 0.014
			6 R1/8 7645 06 10 7 10.5 25 27.5 16 6 11.5 21.5 0.012
			Pre-coated thread

7649 Miniature Swivel Outlet Flow Regulator Supply, Male BSPP and Metric Thread

		Technical polymer, nickel-plated brass, NBR	ØD C  F G H _{min} H _{max} H1 H2 L kg
			4 M5x0.8 7649 04 19 6 8.5 23.5 26 14 6.5 19 0.015
			4 G1/8 7649 04 10 7 8.5 27 29.5 14 8.5 19.5 0.014
			6 M5x0.8 7649 06 19 6 10.5 23.5 26 16 6.5 21 0.008
			6 G1/8 7649 06 10 7 10.5 27 29.5 16 8.5 21.5 0.015

Associated Products

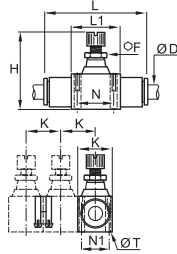
All our flow control regulators are compatible with the range of polyamide and polyurethane tubing shown in Chapter 3.

In-Line Regulators with External Adjustment

7770 In-Line One-Way Flow Regulator



Technical polymer, NBR

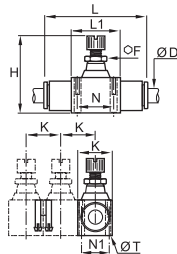


ØD		F	H _{min}	H _{max}	K	L	L1	N	N1	ØT	kg
4	7770 04 00	5	29.5	33.5	12	36	15	11	8	2.2	0.010
6	7770 06 00	8	40.5	44.5	17	51	23	17	11	3.2	0.028
8	7770 08 00	11	46.5	52.5	18.5	58	26	20	12.5	3.2	0.048
10	7770 10 00	14	53	61	24	73	33	26	16	4.2	0.097
12	7770 12 00	14	59	67.5	28	85	35	27.5	20	4.2	0.132

7772 Bi-Directional In-Line Flow Regulator



Technical polymer, NBR

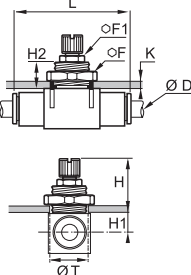


ØD		F	H _{min}	H _{max}	K	L	L1	N	N1	ØT	kg
4	7772 04 00	5	29.5	33.5	12	36	15	11	8	2.2	0.011
6	7772 06 00	8	40	44.5	17	51	23	17	11	3.2	0.032
8	7772 08 00	11	46.5	52.5	18.5	58	26	20	12.5	3.2	0.054

7776 Panel-Mountable In-Line One-Way Flow Regulator



Technical polymer, NBR



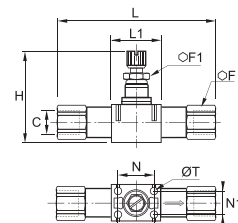
ØD		F	F1	H	H _{max}	H1	H2	K	L	ØT	kg
4	7776 04 00*	14	-	21.5	25.5	6.5	11	6	36	10.5	0.017
6	7776 06 00*	19	-	27.5	32.5	7.5	13.5	7	51	16.5	0.042
8	7776 08 00	24	11	28.5	34.5	9	13.5	7	58	18.5	0.069
10	7776 10 00	30	14	29.5	38.5	11.5	13.5	7	73	24.5	0.136
12	7776 12 00	32	14	32	42	12.5	15.5	8	85	27.5	0.185

*Ultrafine adjustment

7771 In-Line One-Way Flow Regulator, Female BSPP Thread



Technical polymer, nickel-plated brass, NBR



C		F	F1	H _{min}	H _{max}	L	L1	N	N1	ØT	kg
G1/8	7771 10 10	13	8	39.5	44.5	68.5	23	17	11	3.2	0.043
G1/4	7771 13 13	16	11	44	50	83	26	20	12.5	3.2	0.103
G3/8	7771 17 17	19	14	52	61	97	33	26	16	4.2	0.160
G1/2	7771 21 21	24	14	57.5	67.5	121	35	27.5	20	4.2	0.260

7000 Joining Clips



Technical polymer



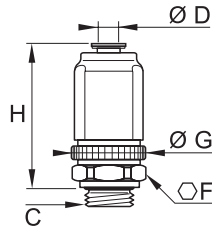
ØD		kg
4	7000 00 05	0,004
6	7000 00 05	0,004
8	7000 00 05	0,004
10	7000 00 06	0,009
12	7000 00 06	0,009

In-Line Regulators with External Adjustment

7020 Straight Flow Regulator Exhaust, Male BSPP Thread



Technical polymer, nickel-plated brass, NBR



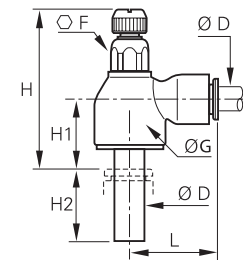
ØD	C		F	G	H min	H max	kg
4	G1/8	7020 04 10	18	21.5	38.5	44	0.062
6	G1/8	7020 06 10	18	21.5	38.5	44	0.058
	G1/4	7020 06 13	18	21.5	38.5	44	0.059
8	G1/8	7020 08 10	24	27	46.5	52.5	0.110
	G1/4	7020 08 13	24	27	46.5	52.5	0.112

Plug-In Regulators with External Adjustment

7030 Compact Plug-In Flow Regulator, Exhaust



Technical polymer, nickel-plated brass, NBR

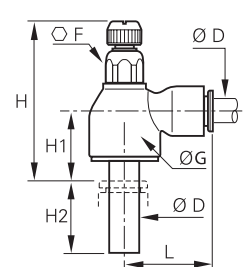


ØD		F	G	H min	H max	H1	H2	L	kg
6	7030 06 00	10	16	35	41	14	17	22	0.013
8	7030 08 00	14	19	39.5	46.5	16	21.5	28	0.022
10	7030 10 00	17	23	43.5	51.5	17.5	24.5	31.5	0.030
12	7030 12 00	17	23	43	51	17	27	35	0.044

7031 Compact Plug-In Flow Regulator, Supply



Technical polymer, nickel-plated brass, NBR

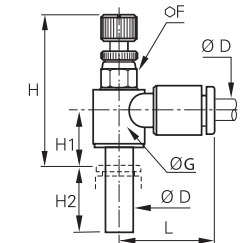


ØD		F	G	H min	H max	H1	H2	L	kg
6	7031 06 00	10	16	35	41	14	17	22	0.013
8	7031 08 00	14	19	39.5	46.5	16	21.5	28	0.035
10	7031 10 00	17	23	43.5	51.5	17.5	24.5	31.5	0.010
12	7031 12 00	17	23	43	51	17	27	35	0.044

7630 Miniature Plug-In Flow Regulator, Exhaust



Technical polymer, nickel-plated brass, NBR

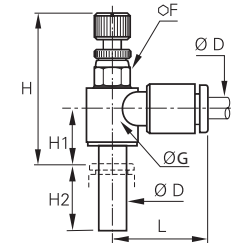


ØD		F	G	H min	H max	H1	H2	L	kg
4	7630 04 00	6	9	25.5	28	9.5	15.5	17	0.007
6	7630 06 00	7	11.5	27.5	29	10.5	17	18.5	0.012

7631 Miniature Plug-In Flow Regulator, Supply



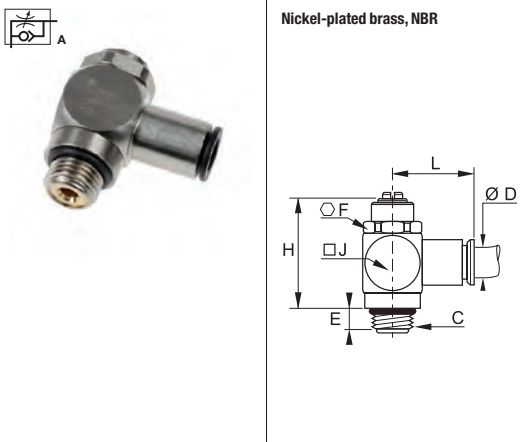
Technical polymer, nickel-plated brass, NBR



ØD		F	G	H min	H max	H1	H2	L	kg
4	7631 04 00	6	9	25.5	28	9.5	15.5	17	0.007
6	7631 06 00	7	11.5	27.5	29	10.5	17	18.5	0.011

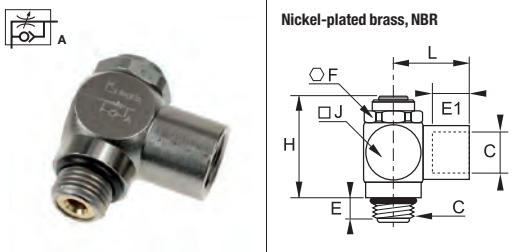
Metal Regulators with Recessed Adjustment

7130 Flow Regulator, Exhaust, Male BSPP and Metric Thread



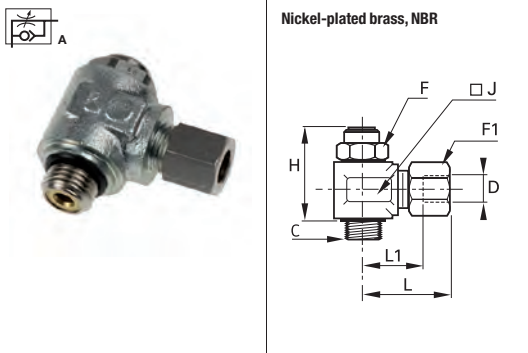
ØD	C		E	F	H	J	L	kg
4	M5x0.8	7130 04 19	4	8	17	9	19	0.015
	G1/8	7130 04 10	5	13	34	15	20	0.037
6	M5x0.8	7130 06 19	4	8	17	9	24	0.013
	G1/8	7130 06 10	5	13	34	15	22	0.038
8	G1/4	7130 06 13	8	17	39	18	24	0.062
	G1/8	7130 08 10	5	13	34	15	25	0.042
10	G1/4	7130 08 13	8	17	39	18	28	0.066
	G3/8	7130 08 17	7	20	47	21.5	29	0.109
12	G1/4	7130 10 13	8	17	39	18	30	0.075
	G3/8	7130 10 17	7	20	47	21.5	32	0.120
12	G1/2	7130 10 21	8	23	61	28	34	0.222
	G3/8	7130 12 17	7	20	47	22	36	0.064
	G1/2	7130 12 21	8	23	61	28	38	0.306

7140 Flow Regulator, Exhaust, Male/Female BSPP and Metric Thread



C		E	E1	F	H	J	L	kg
M5x0.8	7140 19 19	4	4	8	21	9	11	0.009
G1/8	7140 10 10	5	8	13	32	15	17	0.040
G1/4	7140 13 13	8	12	17	39	18	24	0.073
G3/8	7140 17 17	7	12	20	47	21.5	27	0.125
G1/2	7140 21 21	8	15	23	61	28	31	0.238

7160 Flow Regulator with Brass Compression Fitting, Exhaust, Male BSPP Thread




ØD	C		F	F1	H	J	L	L1	kg
4	G1/8	7160 04 10	13	10	26	17	25.5	14.5	0.049
	G1/8	7160 06 10	13	13	26	17	25.5	14.5	0.054
6	G1/4	7160 06 13	17	13	31.5	22	28.5	17.5	0.103
	G1/8	7160 08 10	13	14	26	17	29.5	15.5	0.055
8	G1/4	7160 08 13	17	14	31.5	22	31	17	0.103
	G1/4	7160 10 13	17	19	31.5	22	35	19	0.118
10	G3/8	7160 10 17	20	19	44.5	22	37.5	19	0.188
	G1/2	7160 10 21	23	19	50	27	37.5	19	0.202
12	G3/8	7160 12 17	20	22	44.5	22	38	21.5	0.200
	G1/2	7160 12 21	23	22	50	27	38	21.5	0.213

Flow Control Regulators


Function Fittings

Metal Regulators with External Adjustment


7100 Compact Flow Regulator, Exhaust, Male BSPP Thread

ØD	C		F	F1	H	H	H1	L	kg
					min	max			
4	G1/8	7100 04 10	10	19	47	53	23	21	0.078
	G1/4	7100 06 10	10	19	47	53	23	24.5	0.080
6	G1/8	7100 08 13	10	19	47.5	53	23.5	24.5	0.083
	G1/4	7100 10 13	14	19	50	55	24.5	29	0.097
8	G1/4	7100 08 13	14	19	50	56	25	29	0.100
	G3/8	7100 08 17	17	25	56	62	27	30.5	0.154
10	G1/4	7100 10 13	14	19	50	56	25	35	0.103
	G3/8	7100 10 17	17	25	56	62	27	35	0.157
12	G3/8	7100 12 17	17	25	56	62	27	38	0.198
	G1/2	7100 12 21	17	25	55	62	27	38	0.207
14	G1/2	7100 14 21	17	25	55	62	27	41	0.205


7101 Compact Flow Regulator, Supply, Male BSPP Thread

ØD	C		F	F1	H	H	H1	L	kg
					min	max			
4	G1/8	7101 04 10	10	19	47	53	23	21	0.096
	G1/4	7101 06 10	10	19	47	53	23	24.5	0.080
6	G1/8	7101 06 10	10	19	47.5	53	23.5	24.5	0.080
	G1/4	7101 08 10	14	19	50	55	24.5	29	0.097
8	G1/4	7101 08 13	14	19	50	56	25	29	0.100
	G3/8	7101 08 17	17	25	56	62	27	30.5	0.155


7680 Compact Flow Regulator, Male BSPP Thread

ØD	C		E	F	H	H	J	L	kg
					min	max			
6	G1/8	7680 06 10	5	13	39	44	7.5	24.5	0.045
	G1/4	7680 08 10	5	13	39	44	7.5	24.5	0.047
8	G1/8	7680 08 13	8	17	41	47	9	27	0.076
	G1/4	7680 10 13	7	20	50	60	11	34	0.133
12	G1/2	7680 12 21	8	23	65	77	14	36.5	0.165

7180 Miniature Flow Regulator Exhaust, Male BSPP and Metric Thread

ØD	C		E	F	H	H	J	L	kg
					min	max			
4	M5x0.8	7180 04 19	4	8	24	29	10	19	0.012
	G1/8	7180 04 10	5	13	39	44	15	20	0.042
6	M5x0.8	7180 06 19	4	8	24	29	10	24	0.015
	G1/8	7180 06 10	5	13	39	44	15	22	0.043
8	G1/8	7180 08 10	5	13	39	44	15	26	0.049

7110 Compact Flow Regulator Exhaust, Male/Female BSPP Thread

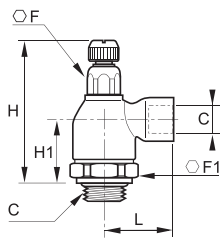
C		F	F1	H	H	H1	L	kg
				min	max			
G1/8	7110 10 10	10	19	47	52.5	23	22.5	0.079
G1/4	7110 13 13	14	19	50.5	55.5	25	32	0.108
G3/8	7110 17 17	17	25	56	62	27	34.5	0.212
G1/2	7110 21 21	17	25	55	62	27	37.5	0.192

Metal Regulators with External Adjustment

7111 Compact Flow Regulator Supply, Male/Female BSPP Thread



Nickel-plated brass, NBR

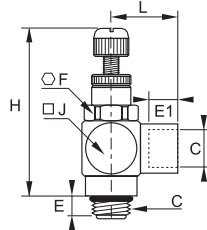


C		F	F1	H min	H max	H1	L	kg
G1/8	7111 10 10	10	19	47	52.5	23	22.5	0.079
G1/4	7111 13 13	14	19	50.5	55.5	25	32	0.107

7190 Miniature Flow Regulator Exhaust, Male/Female BSPP and Metric Thread



Nickel-plated brass, NBR

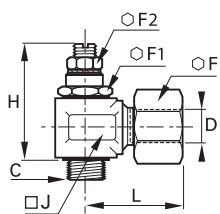


C		E	E1	F	H min	H max	J	L	kg
M5x0.8	7190 19 19	4	4	8	24	29	10	11	0.012
G1/8	7190 10 10	5	8	13	39	44	15	17	0.044

7762 Flow Regulator Exhaust, with Brass Compression Fitting, Male BSPP Thread



Brass, NBR



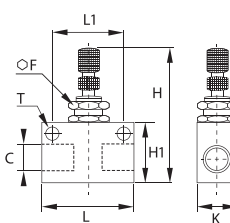
ØD	C		F	F1	F2	H min	H max	J	L	kg
8	G1/8	7762 08 10*	14	14	7	35.5	38.5	17	28.5	0.056
10	G1/4	7762 10 13	19	17	10	44	49	22	36.5	0.129
14	G3/8	7762 14 17	24	22	13	58	65	27	37.5	0.219
18	G1/2	7762 18 21	30	27	19	62.5	68.5	34	44	0.403

*with adjustment knurl

7170 Panel-Mountable In-Line Flow Regulator, Female BSPP and Metric Thread



Treated aluminium, NBR



C		F	H min	H max	H1	K	L	L1	ØT	kg
M5x0.8	7170 19 19	12	38	42	15	12	25	18	4.5	0.022
G1/8	7170 10 10	15	49	56	22	18	35	24.7	4.5	0.056
G1/4	7170 13 13	15	57	64	30	20	46	35	6.5	0.086
G3/8	7170 17 17	22	62	73	30	25	50	35	6.5	0.155
G1/2	7170 21 21	22	72	83	40	25	60	44	6.5	0.196

Flow Control Regulators

Function Fittings

Stainless Steel Flow Control Regulators

Stainless steel flow control regulators are used to **regulate the speed of a cylinder rod** as well as gas flow in environments with high mechanical or chemical constraints.

Product Advantages

Robust Suitable for corrosive environments
 Excellent mechanical and chemical resistance
 100% leak-tested in production
 No contamination of conveyed fluids

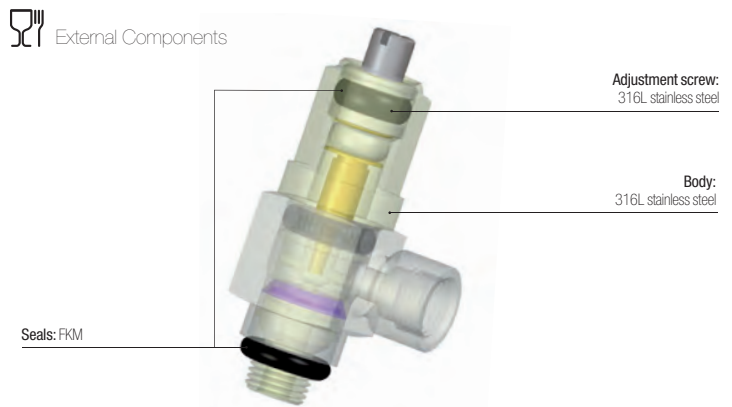
Optimised Design Smooth external surfaces to facilitate cleaning
 Fully compatible with food environments
 Accurate and easy adjustment

Applications
 Food Process
 Robotics
 Textile
 Semi-Conductors
 Packaging
 Pneumatics
 Automotive Process

Technical Characteristics

Compatible Fluids	Compressed air 7822: all compatible fluids depending on whether FKM or PTFE seals are used
Working Pressure	7810-7812: 1 to 10 bar 7820: 1 to 16 bar 7822: 1 to 40 bar
Working Temperature	7810 – 7812: 0°C to +70°C 7820 – 7822: -15° to +120°C

Component Materials

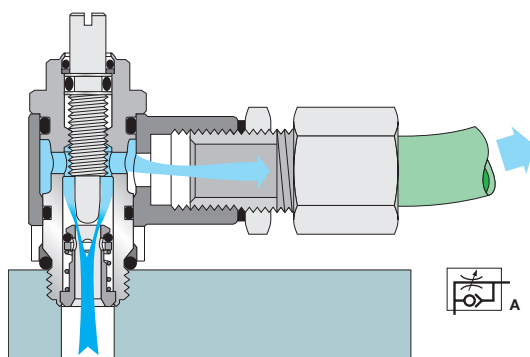


Regulations

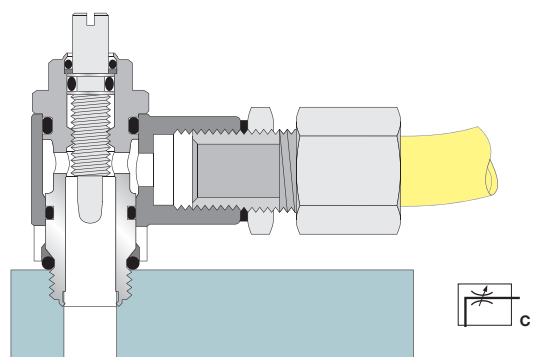
DI: 2002/95/EC (RoHS)
 RG: 1907/2006 (REACH)
 DI: 97/23/EC (PED)
 RG: External Components: 21CFR (FDA)
 RG: External Components: 1935/2004/EC

Operation

Exhaust Model with External Adjustment


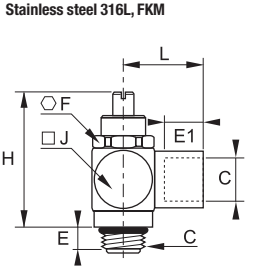



Bi-Directional Model with External Adjustment


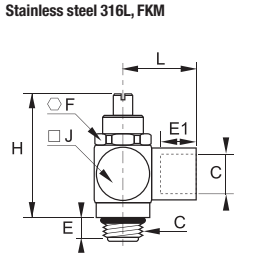



Stainless Steel Flow Control Regulators


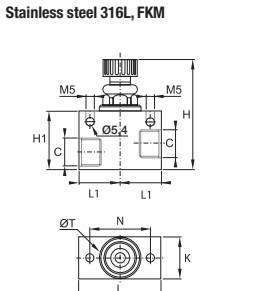

7810 Flow Regulator Exhaust, Male/Female BSPP and Metric Thread

		Stainless steel 316L, FKM	C		E	E1	F	H_{min}	H_{max}	J	L	kg
			M5x0.8	7810 19 19	4	4	8	22	26	9	11	0.011
			G1/8	7810 10 10	6	8	13	32	38	15	17	0.039
			G1/4	7810 13 13	9	12	17	35	40	18	24	0.072
			G3/8	7810 17 17	8	12	20	43	53	22	27	0.125
			G1/2	7810 21 21	9	15	23	60	71	28	31	0.261


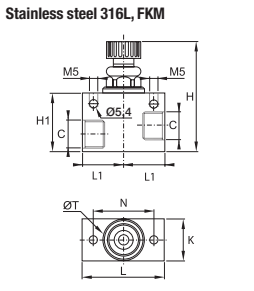

7812 Bi-Directional Flow Regulator, Male/Female BSPP and Metric Thread

		Stainless steel 316L, FKM	C		E	E1	F	H_{min}	H_{max}	J	L	kg
			M5x0.8	7812 19 19	4	4	8	22	26	9	11	0.290
			G1/8	7812 10 10	6	8	13	32	38	15	17	0.040
			G1/4	7812 13 13	9	12	17	35	40	18	24	0.074
			G3/8	7812 17 17	8	12	20	43	53	22	24	0.125
			G1/2	7812 21 21	9	15	23	60	71	28	31	0.261

7820 In-Line One-Way Flow Regulator, Female BSPP Thread

		Stainless steel 316L, FKM	C	DN		H_{min}	H_{max}	H1	K	L	L1	N	ØT	kg	
			G1/8	7	7820 00 10	47	52.5	30	20	40	20	30	20	20	0.175
			G1/4	7	7820 00 13	47	52.5	30	20	40	20	30	20	20	0.164
			G3/8	9	7820 00 17	56	65	35	25	50	25	36	25	25	0.298
			G1/2	12	7820 00 21	76	87	40	30	60	30	42	30	30	0.261

7822 Bi-Directional In-Line Flow Regulator, Female BSPP Thread

		Stainless steel 316L, FKM	C	DN		H_{min}	H_{max}	H1	K	L	L1	N	ØT	kg	
			G1/8	7	7822 00 10	48	52.5	30	20	40	20	30	20	20	0.176
			G1/4	7	7822 00 13	48	52.5	30	20	40	20	30	20	20	0.165
			G3/8	9	7822 00 17	58	65	35	25	50	25	36	20	20	0.296
			G1/2	12	7822 00 21	76	87	40	30	60	30	42	30	30	0.270

You will also find our range of stainless steel push-in fittings, compression fittings, valves and accessories in this catalogue.

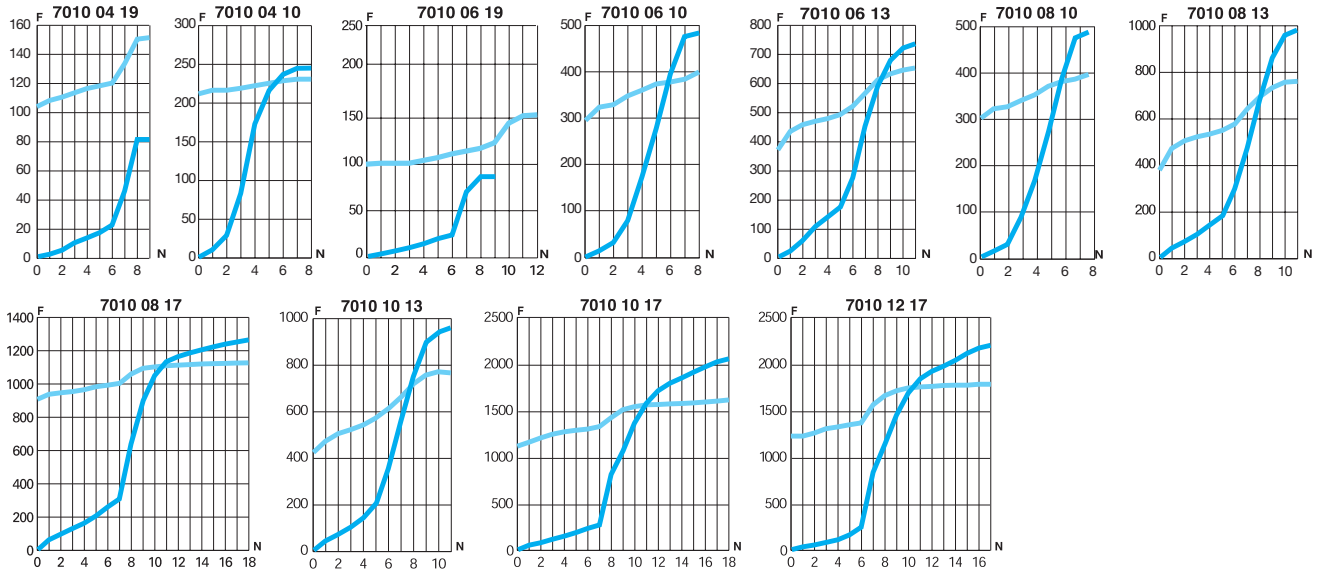
Flow Characteristics (at 6 bar)

for Flow Control Regulators

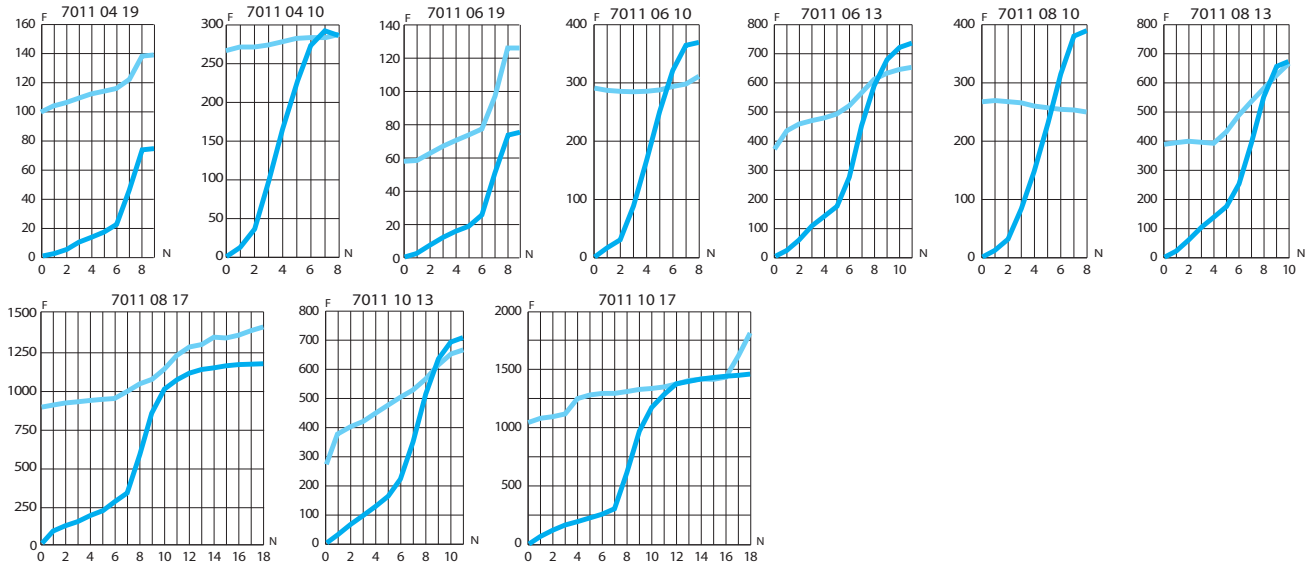


7010
7011
7012

7010



7011



7012

Flow characteristics for model 7012:

- exhaust version (see model 7010, direction of adjustment)
- supply version (see model 7011, direction of adjustment)

6 bar

Direction of adjustment
 Return

F: Flow in NI/min

N: Number of turns

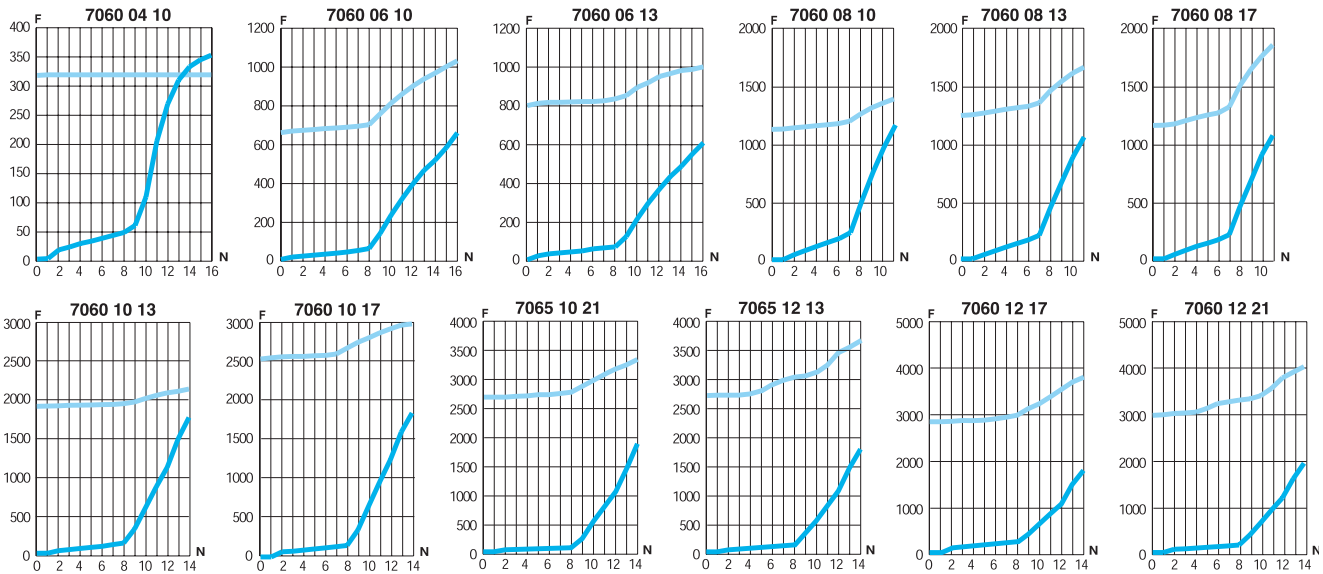
Flow Characteristics (at 6 bar)

for Flow Control Regulators

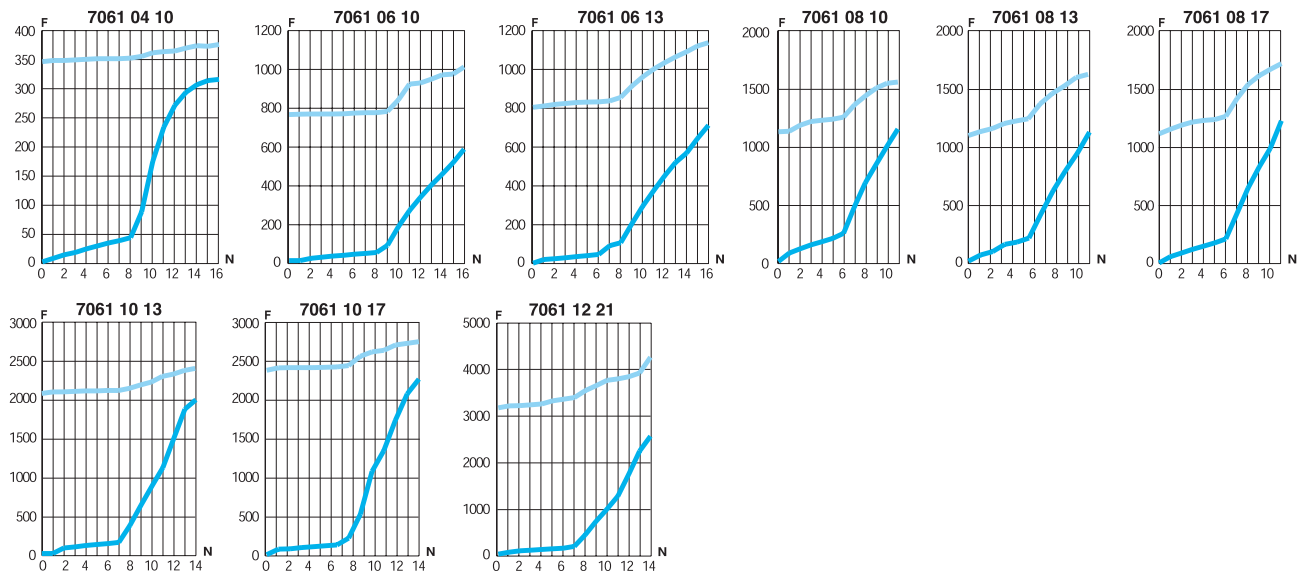


7060
7061
7062

7060



7061



7062

Flow characteristics for model 7062:

- exhaust version (see model 7060, direction of adjustment)
- supply version (see model 7061, direction of adjustment)

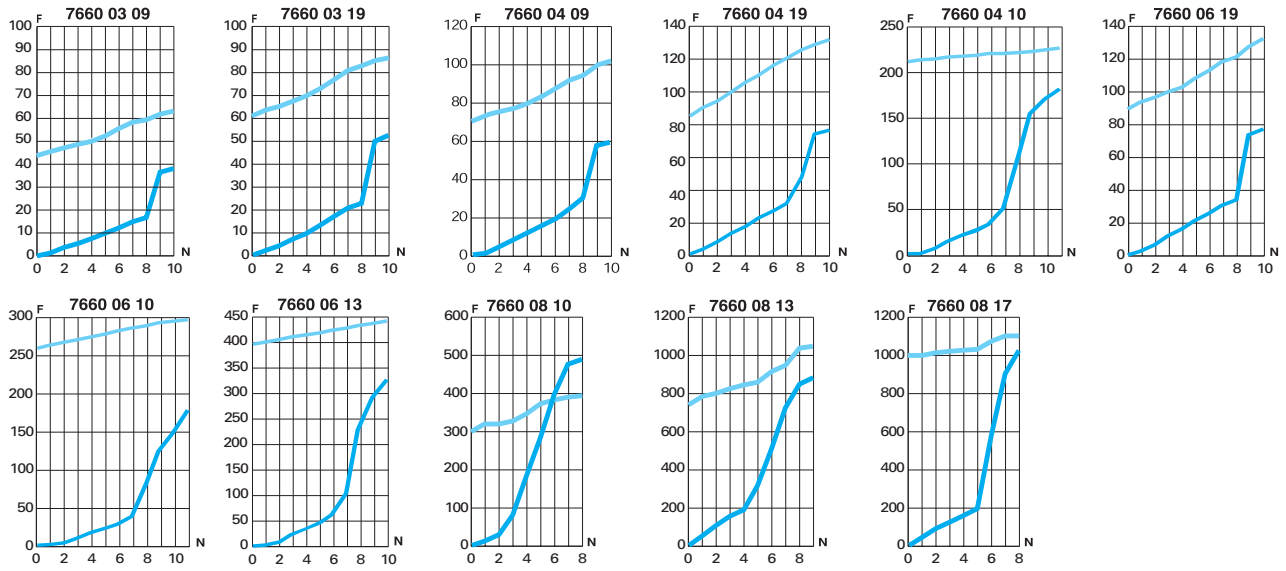
Flow Characteristics (at 6 bar)

for Flow Control Regulators

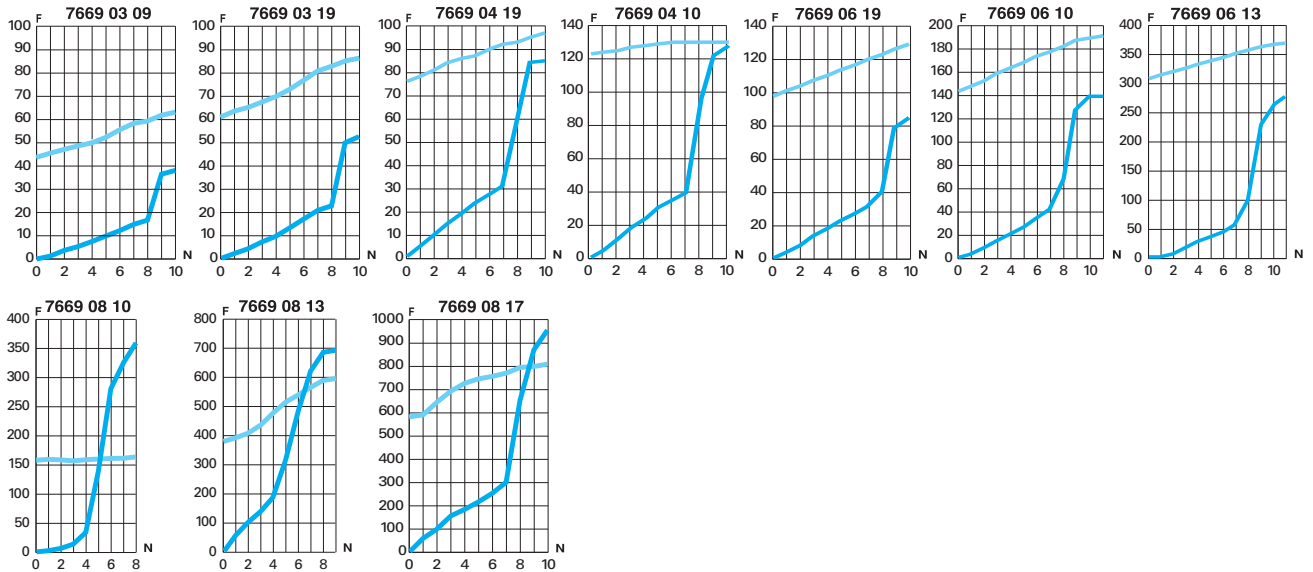


7660
7669
7662

7660



7669



7662

Flow characteristics for model 7662:

- exhaust version: see model 7660, direction of adjustment
- supply version: see model 7669, direction of adjustment

6 bar

Direction of adjustment
 Return

F: Flow in NL/min

N: Number of turns

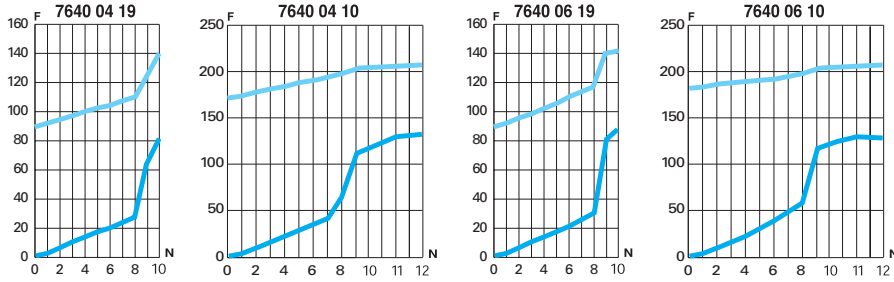
Flow Characteristics (at 6 bar)

for Flow Control Regulators

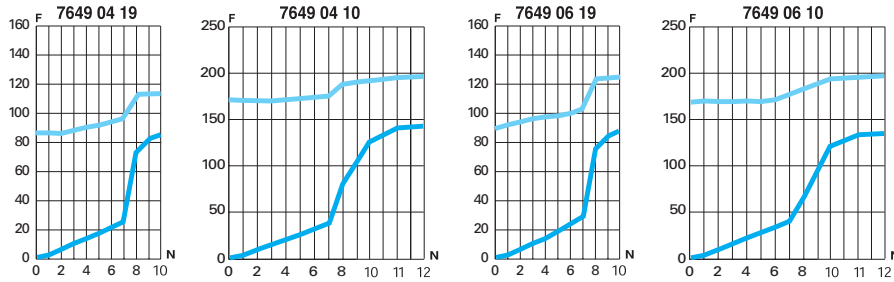


7640
7649

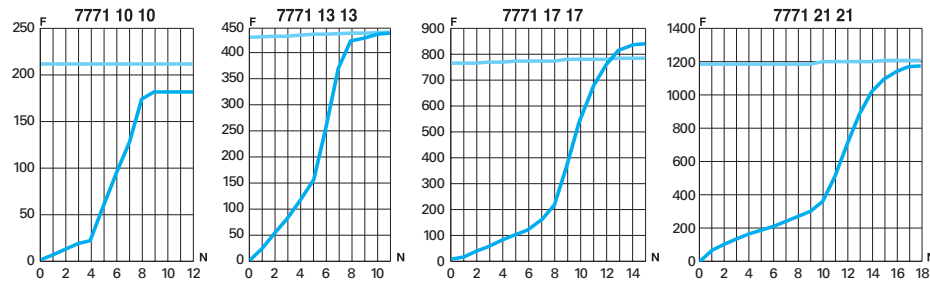
7640



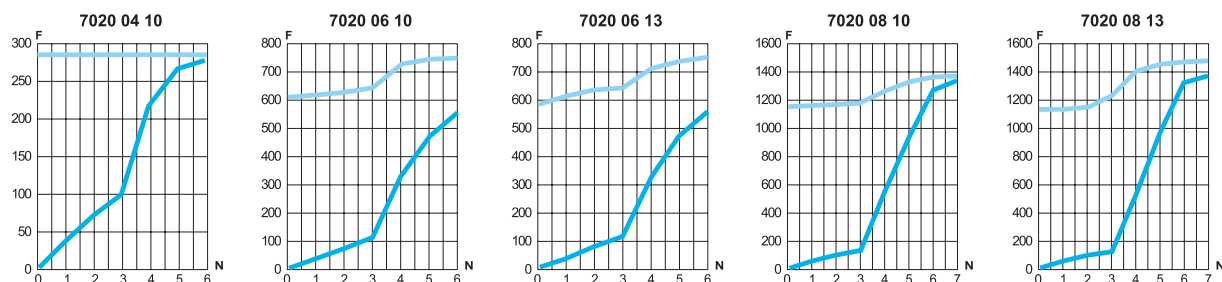
7649



7771



7020

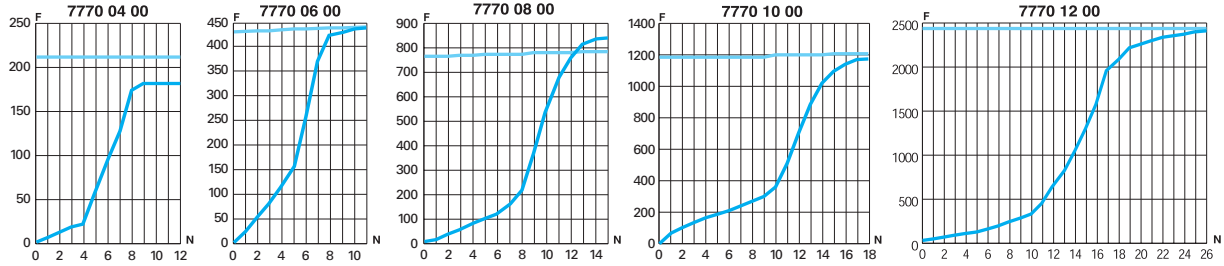


Flow Characteristics (at 6 bar)

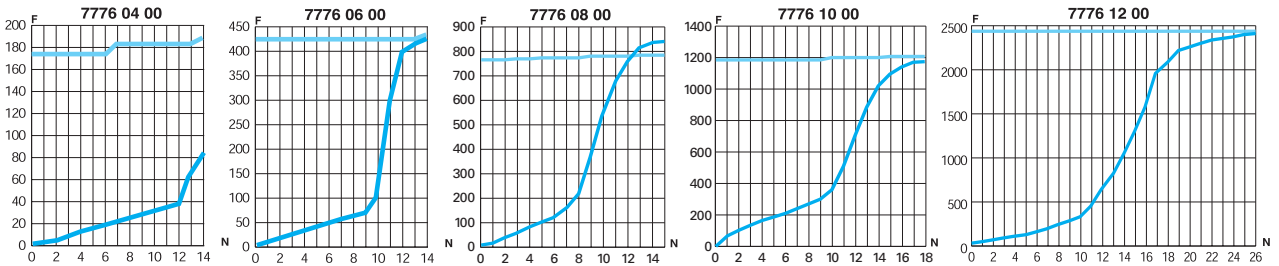
for Flow Control Regulators



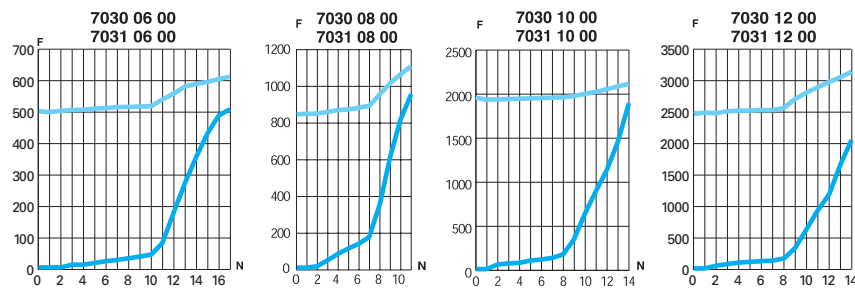
7770



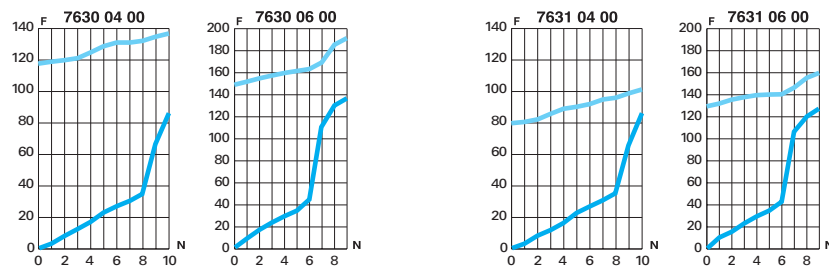
7776



7030
7031



7630
7631



6 bar
█ Direction of adjustment
█ Return
F: Flow in NI/min
N: Number of turns

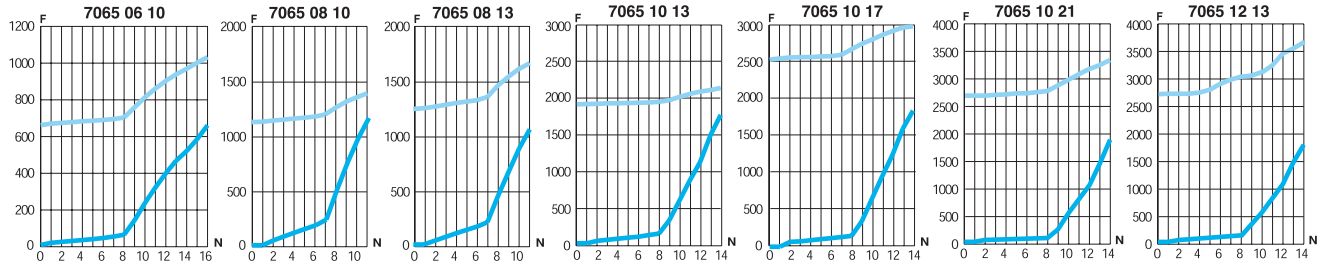
Flow Characteristics (at 6 bar)

for Flow Control Regulators

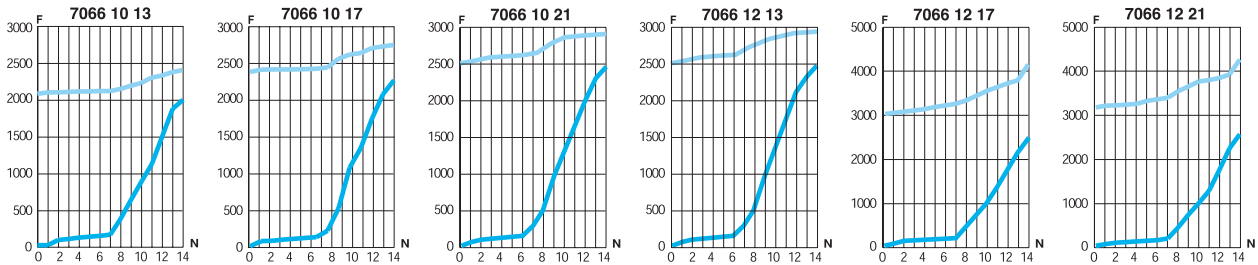


7065
7066
7067

7065



7066



7067

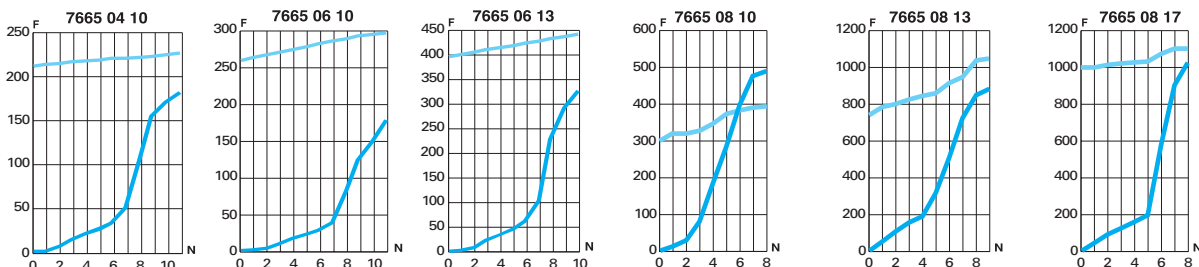
Flow characteristics for model 7067:

- exhaust version: see model 7065, direction of adjustment
- supply version: see model 7066, direction of adjustment

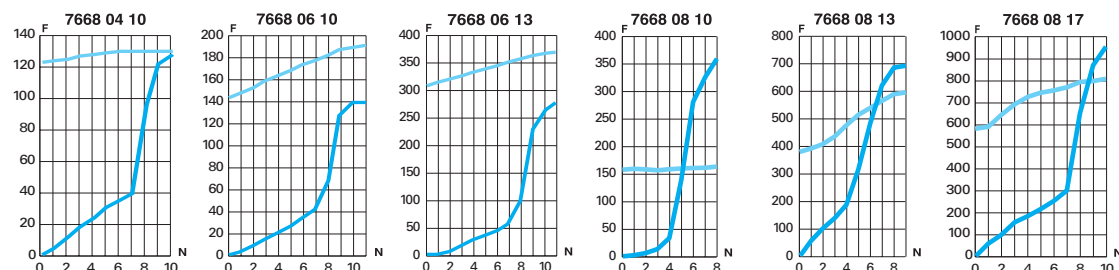


7665
7668

7665



7668

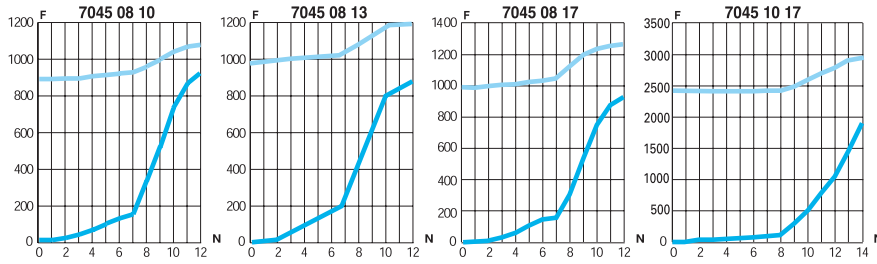


Flow Characteristics (at 6 bar)

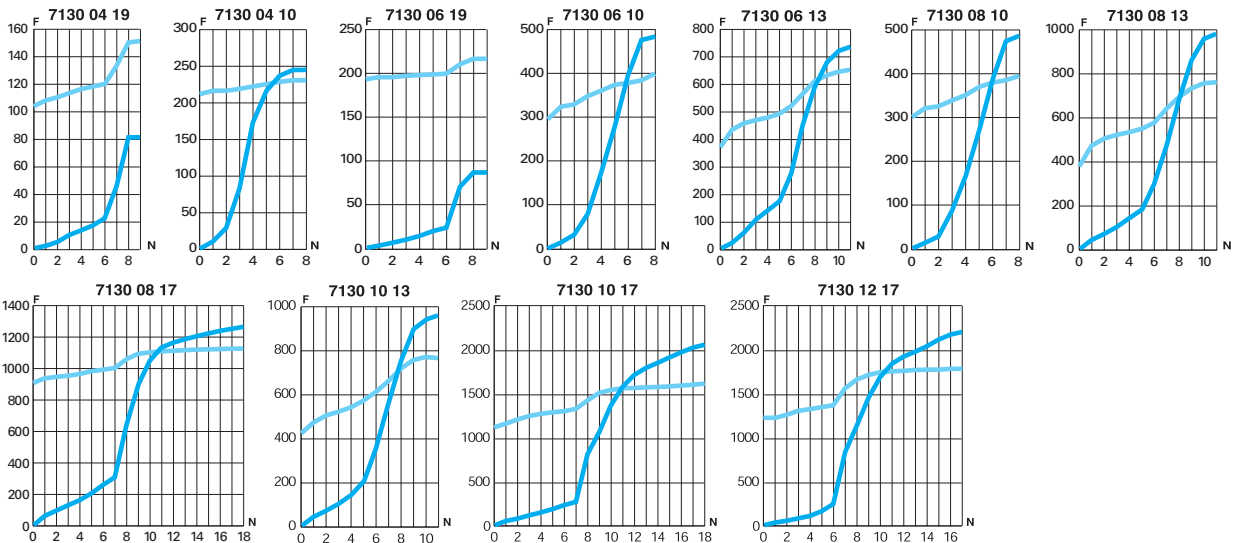
for Flow Control Regulators



7045



7130



6 bar

Direction of adjustment
 Return

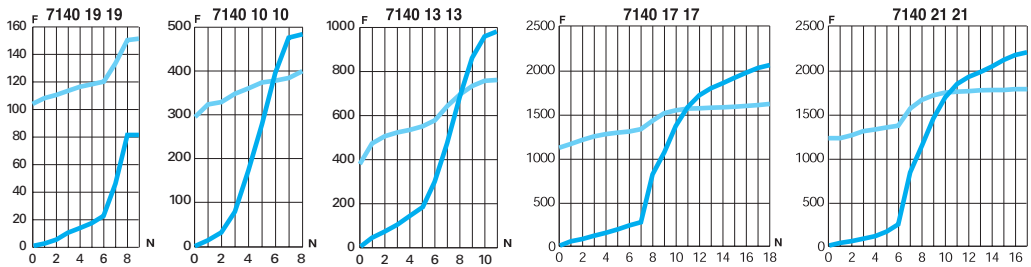
F: Flow in NL/min
N: Number of turns

Flow Characteristics (at 6 bar)

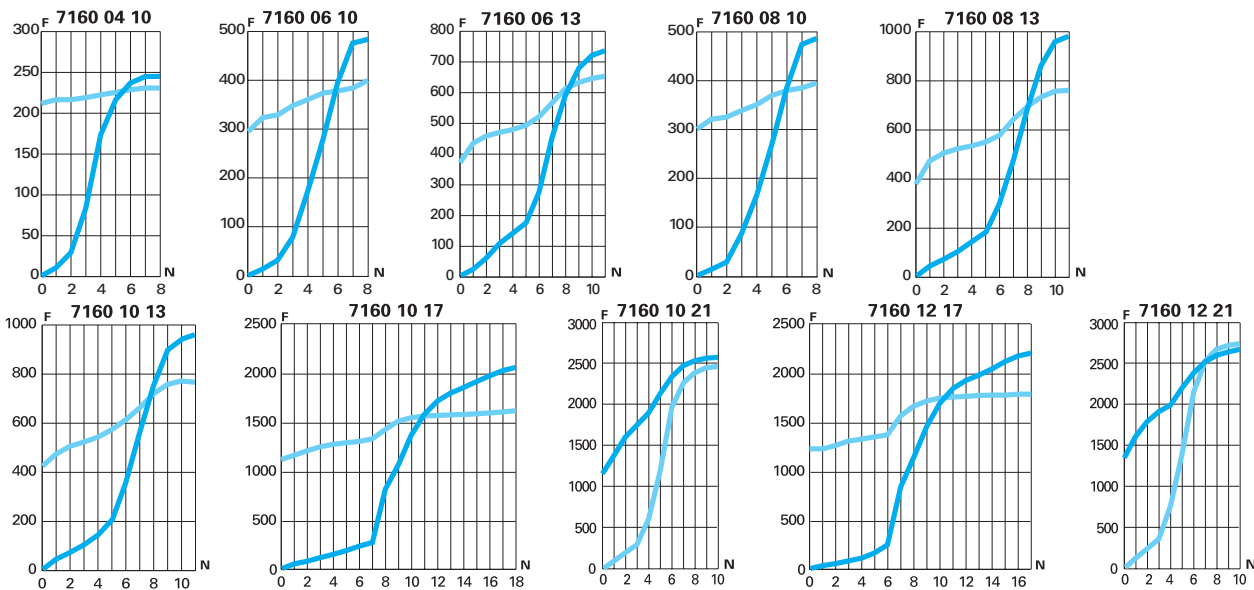
for Flow Control Regulators



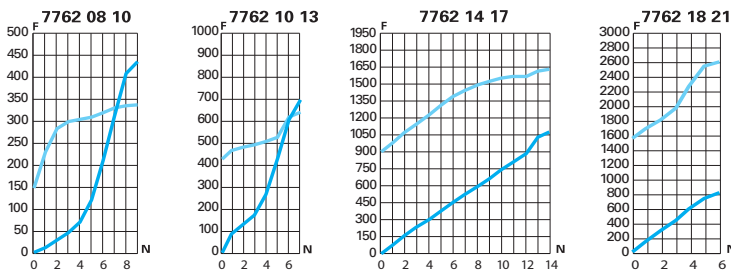
7140



7160



7762



Flow Control Regulators

Function Fittings

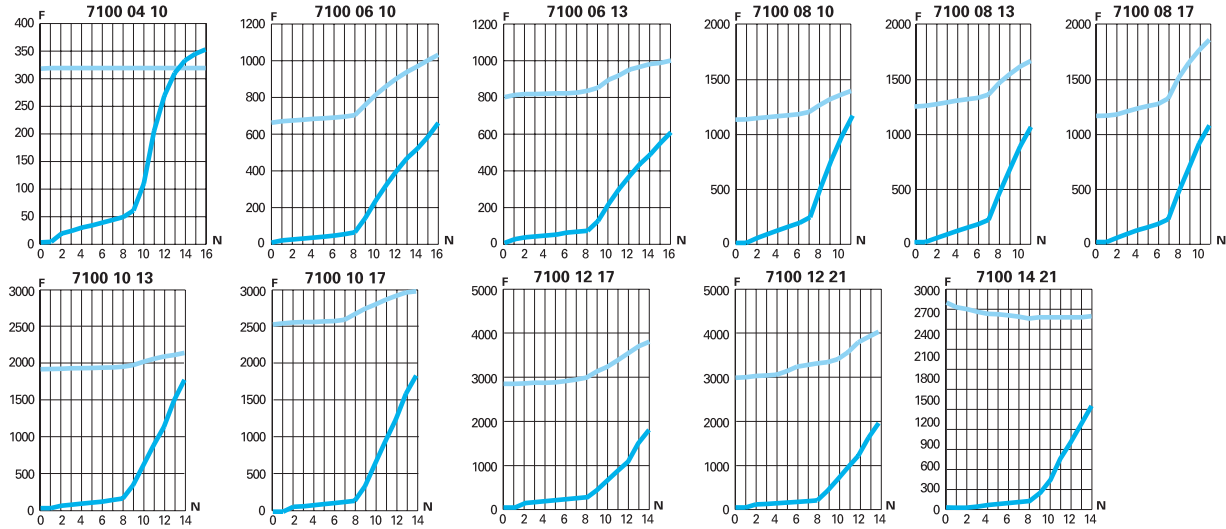
Flow Characteristics (at 6 bar)

for Flow Control Regulators

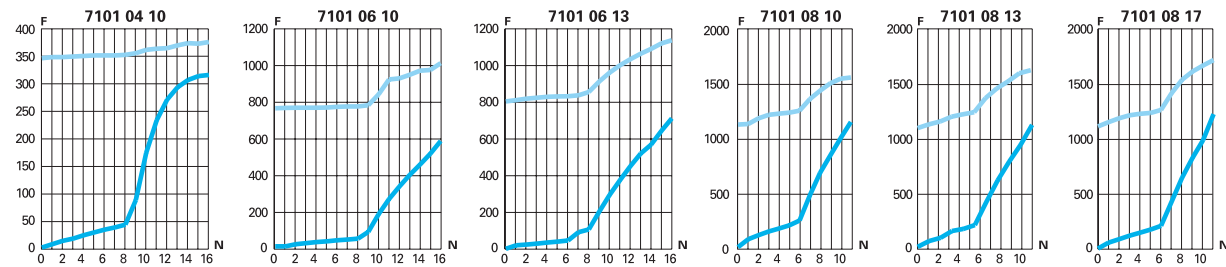


7100
7101

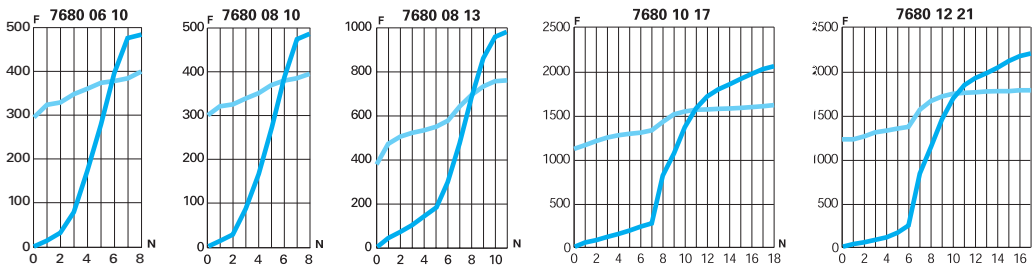
7100



7101



7680



6 bar

Direction of adjustment
 Return

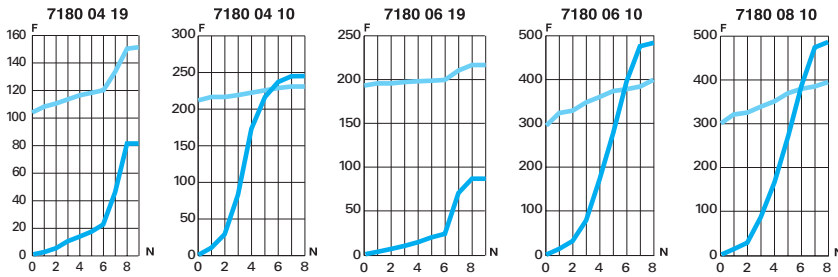
F: Flow in NL/min
N: Number of turns

Flow Characteristics (at 6 bar)

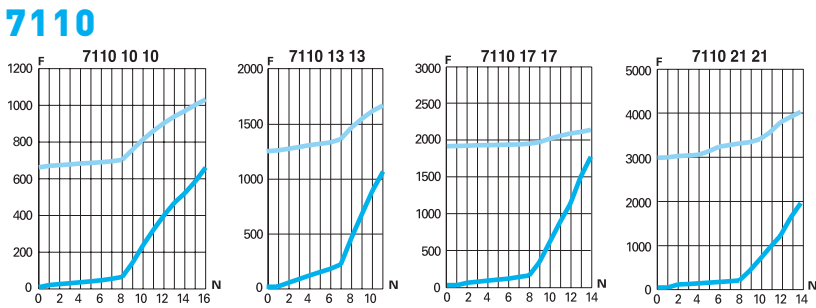
for Flow Control Regulators



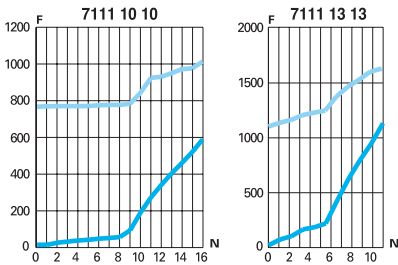
7180



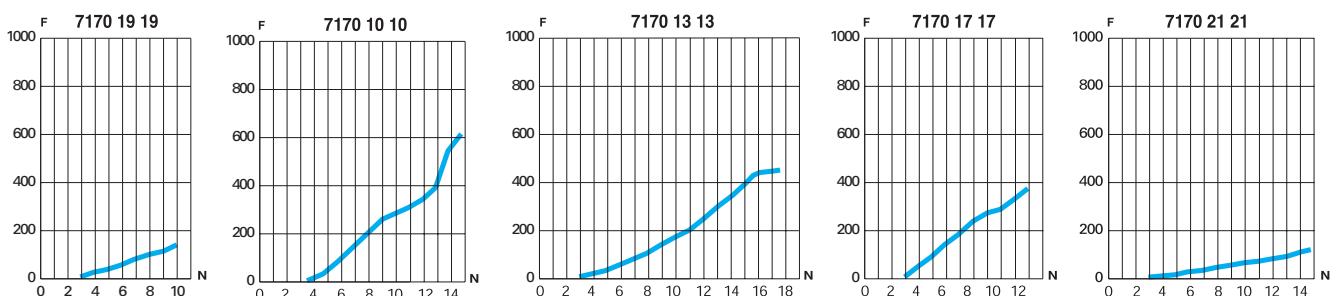
7110 7111



7111



7170



Function Fittings Range

Blocking Fittings

- 7880**
BSPP
Page 4-37
- 7881**
BSPP
Page 4-37
- 7885**
BSPT
Page 4-37
- 7886**
BSPT
Page 4-37
- 7883**
BSPP
Page 4-37



Piloted Non-Return Valves

- 7892**
BSPP
Page 4-39
- 7894**
BSPP
Page 4-39



Non-Return Valves

- 7996**
Page 4-41
- 7984**
7994
BSPP/Metric
Page 4-41
- 7985**
7995
BSPT
Page 4-41



Adjustable Non-Return Valves

- 7930**
BSPP/Metric
Page 4-43
- 7931**
BSPP
Page 4-43
- 7932**
BSPP
Page 4-43



LIQUIfit® Non-Return Valves

- 7992**
Page 4-45



Stainless Steel Non-Return Valves

- 4890**
BSPP
Page 4-47
- 4891**
BSPP
Page 4-47
- 4892**
BSPP
Page 4-47
- 4895**
NPT
Page 4-47



Soft Start Fittings

- 7860**
BSPP
Page 4-49
- 7870**
BSPP
Page 4-49
- 7861**
BSPP
Page 4-49
- 7871**
BSPP
Page 4-49



Pneumatic Sensor Fittings

- 7818**
BSPP/Metric
Page 4-51
- 7828**
BSPP/Metric
Page 4-51



Pressure Regulator Fittings

- 7300**
BSPP
Page 4-53



Pressure Reducer Fittings

- 7318**
BSPP
Page 4-55
- 7471**
BSPP
Page 4-55
- 7316**
Page 4-55
- 7416**
BSPP
Page 4-55
- 7000**
Page 4-55
- 7000**
Page 4-55



Snap Fittings

- 7926**
Page 4-57
- 7921**
BSPP
Page 4-57
- 7960**
Page 4-57
- 7961**
BSPP
Page 4-57



Manually-Operated Valves

- 7800**
7801
BSPP/Metric
Page 4-59
- 7802**
BSPP
Page 4-59
- 0669**
BSPP/Metric
Page 4-59



Function Fittings Range

Metal Quick Exhaust Valves

- 7970**
BSPP/Metric
Page 4-61
- 7971**
BSPP/BSPT
Page 4-61
- 7899**
BSPP
Page 4-61



Silencers

- 0674**
BSPP/Metric
Page 4-63
- 0676**
BSPP/Metric
Page 4-63
- 0670**
BSPP
Page 4-63
- 0673**
BSPP/Metric
Page 4-63
- 0675**
BSPP/Metric
Page 4-63
- 0671**
Page 4-64
- 0677**
BSPP
Page 4-64
- 0672**
BSPP
Page 4-64
- 0682**
BSPP
Page 4-64
- 0683**
NPT
Page 4-64



Blocking Fittings

Blocking fittings, mounted in pairs on a cylinder, lock the piston by simultaneously **cutting off the supply and exhaust** when the pilot signal is removed.

Product Advantages

Optimum Performance

- Optimum flow: no effect on the performance of the cylinder
- Compact size
- Fully orientable for excellent flexibility in circuit installation
- 100% leak-tested in production
- Date coding to guarantee quality and traceability

Robust

- Suitable for the most demanding environments
- Excellent corrosion and spark resistance to salt spray and sparks (threaded models)
- Proven push-in technology



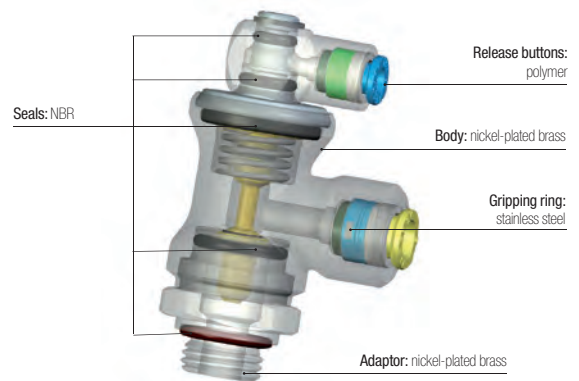
- Applications**
- Robotics
 - Machine Tools
 - Textile
 - Packaging
 - Pneumatics
 - Automotive Process

Technical Characteristics

Compatible Fluids	Compressed air
Working Pressure	1 to 10 bar
Working Temperature	-20°C to +70°C

Connection	Supply Flow 6 bar	Pilot and depilot threshold depending on supply pressure					
			2 bar	4 bar	6 bar	8 bar	10 bar
ØD 6 and 8 mm, threads G1/8, G1/4, R1/8, R1/4	650NI/min	Pilot Pressure	2.40	2.90	3.30	3.60	4.00
	650NI/min	Depilot Pressure	1.50	1.80	2.15	2.40	2.80
ØD 10 and 12 mm, threads G3/8, G1/2, R3/8, R1/2	1600NI/min	Pilot Pressure	2.70	3.20	3.50	3.80	4.10
	1600NI/min	Depilot Pressure	1.40	1.80	2.10	2.40	2.70

Component Materials



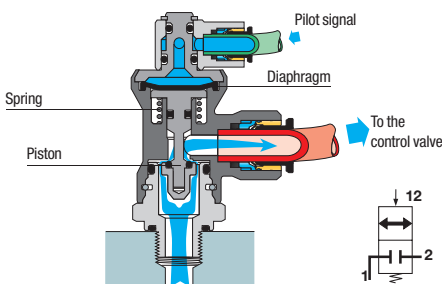
Silicone-free

Regulations

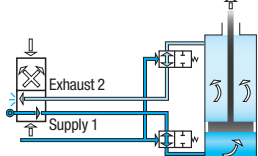
- DI: 2002/95/EC (RoHS)
- DI: 97/23/EC (PED)
- RG: 1907/2006 (REACH)

Operation

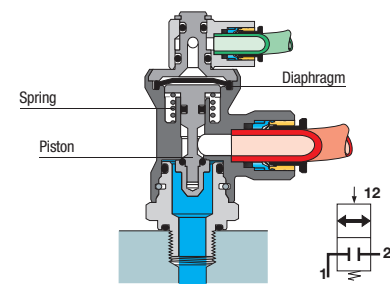
Cylinder in Operation (pilot signal active)



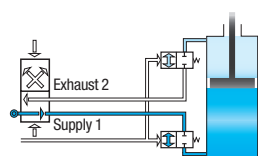
Pilot signal authorises movement



Cylinder Blocked (pilot signal removed)

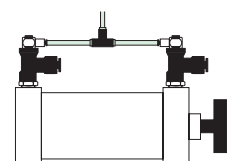
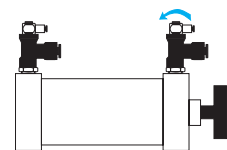


No signal blocks movement



Installation

Mounted in pairs, blocking fittings are installed directly on the cylinder. Being fully orientable, they offer excellent flexibility in the design and installation of pneumatic circuits.



Blocking Fittings

7880 Blocking Fitting, Male BSPP Thread

		Nickel-plated brass, NBR		ØD	C		E	F	G	H	H1	H2	J	L	kg
		6	G1/8	7880 06 10	5.5	21	24	53	24.5	21	17	28	0.126		
		6	G1/4	7880 06 13	6.5	21	24	53	24.5	21	17	28	0.128		
		8	G1/4	7880 08 13	6.5	21	24	53	24.5	21	17	28	0.122		
		8	G3/8	7880 08 17	7.5	21	24	53	24.5	21	17	28	0.127		
		10	G3/8	7880 10 17	7.5	24	28	58	25	25	27	35	0.209		
		12	G1/2	7880 12 21	9	24	28	58	25	25	27	37.5	0.222		

7885 Blocking Fitting, Male BSPT Thread

		Nickel-plated brass, NBR		ØD	C		F	G	H	H1	H2	J	L	kg
		6	R1/8	7885 06 10	21	24	51.5	25	20	17	28	0.127		
		6	R1/4	7885 06 13	21	24	51.5	25	20	17	28	0.131		
		8	R1/4	7885 08 13	21	24	51.5	25	20	17	28	0.126		
		8	R3/8	7885 08 17	21	24	51.5	25	20	17	28	0.130		
		10	R3/8	7885 10 17	24	28	57	25	24	27	35	0.222		
		10	R1/2	7885 12 21	24	28	57	25	24	27	37.5	0.229		

7881 Blocking Fitting, Male/Female BSPP Thread

		Nickel-plated brass, NBR		C1	C2		E	F	G	H	H1	H2	J	L	kg
		G1/8	G1/4	7881 13 10	5.5	21	24	53	24.5	21	17	25.5	0.118		
		G1/4	G1/4	7881 13 13	6.5	21	24	53	24.5	21	17	25.5	0.119		
		G3/8	G3/8	7881 17 17	7.5	24	28	58	25	25	27	34	0.211		
		G1/2	G1/2	7881 21 21	9	24	28	58	25	25	27	40	0.226		

7886 Blocking Fitting, Male/Female BSPT Thread

		Nickel-plated brass, NBR		C1	C2		F	G	H	H1	H2	J	L	kg
		R1/8	R1/4	7886 13 10	21	24	51.5	25	20	17	26.5	0.121		
		R1/4	R1/4	7886 13 13	21	24	51.5	25	20	17	26.5	0.126		
		R3/8	R3/8	7886 17 17	24	28	57	25	24	27	34	0.225		
		R1/2	R1/2	7886 21 21	24	28	57	25	24	27	40	0.240		

7883 Blocker/Flow Regulator, Male BSPP Thread

		Nickel-plated brass, technical polymer, NBR		ØD	C		G	H	H1	L	L_{max}	L1	kg
		4	G1/8	7883 04 10	21.5	53	21	46.5	52	12	0.166		
		6	G1/8	7883 06 10	21.5	53	21	46.5	52	12	0.163		
		6	G1/4	7883 06 13	21.5	53	21	46.5	52	12	0.166		
		8	G1/4	7883 08 13	27	57.5	24.5	54	60	14	0.251		
		8	G3/8	7883 08 17	27	57.5	24.5	54	60	14	0.254		

Combination of blocking and flow regulation functions
Working temperature: 0 to +70°C

Piloted Non-Return Valves

Piloted non-return valves are designed to **protect installations**: if the compressed air supply is removed, they lock the air supply to the cylinder, thus maintaining it in position.

Product Advantages

- | | |
|---------------------------------|---|
| System Protection | Protection of your system
Control of inlet and outlet flow: cylinder operation optimised
Vent saves time on restart after maintenance operations (model 7894) |
| 3 Functions in 1 Product | A multi-purpose fitting:
<ul style="list-style-type: none"> • piloted non-return valve • flow control regulator • manual exhaust All-in-one product: integrated fittings for the control and supply |
| Flexible Operation | Orientable and adjustable through 3 axes
Can be integrated into any installation configuration
Push-in connection for quicker and more reliable installation
Mounted in pairs directly on the cylinder |



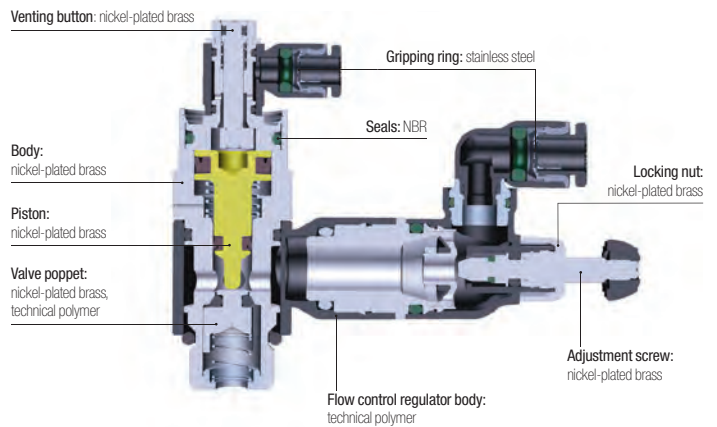
Applications

Pneumatics
Assembly
Robotics
Machine Tools
Packaging
Handling
Automotive Process

Technical Characteristics

Compatible Fluids	Compressed air
Working Pressure	1 to 10 bar
Working Temperature	-5°C to +60°C
Cracking Pressure	0.3 bar

Component Materials



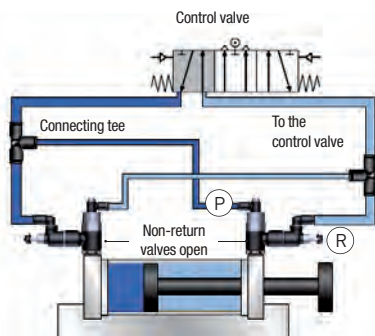
Silicone-free

Regulations

DI: 2002/95/EC (RoHS)
 RG: 1907/2006 (REACH)
 DI: 97/23/EC (PED)

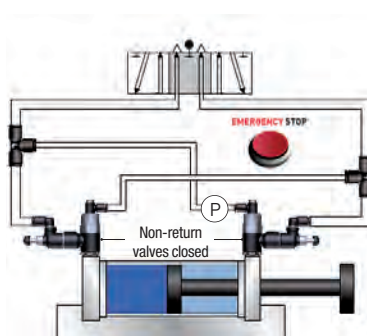
Operation

Normal Operation



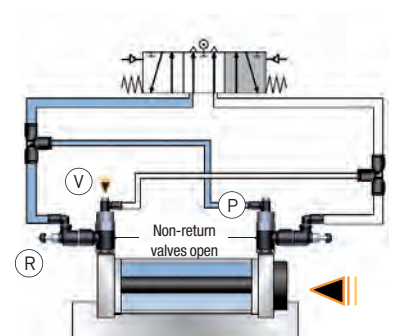
Pilot signal (P)
 Regulation of cylinder rod speed (R)

Emergency Stop or Pressure Drop



Drop/removal of pilot pressure (P) = cylinder rod locked

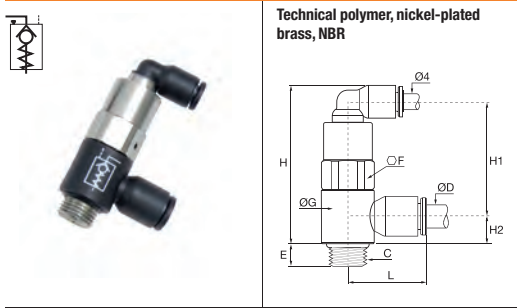

Venting Operation



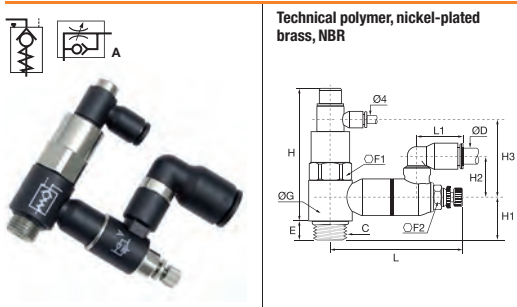

Venting (V) returns the cylinder rod to the to start position, emptying the pressure chamber through the flow regulator (R) and pilot line (P)

Piloted Non-Return Valves

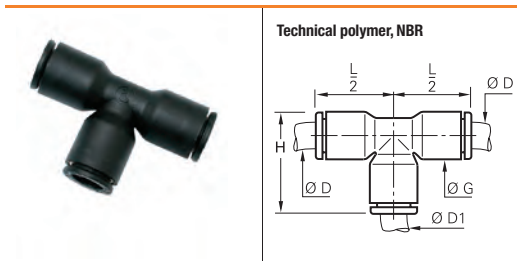

7892 Piloted Non-Return Valve, Male BSPP Thread

	Technical polymer, nickel-plated brass, NBR		ØD	C		E	F	G	H	H1	H2	L	kg
	6	G1/8	7892 06 10	6	13	14	42	30	7	21	0.020		
	6	G1/4	7892 06 13	9	17	18.5	45	32	9	23	0.042		
	8	G1/8	7892 08 10	6	13	14	42	29	9	25	0.020		
	8	G1/4	7892 08 13	9	17	18.5	45	32	9	27	0.042		
	8	G3/8	7892 08 17	6	20	22.5	57	41	11	28	0.093		
	10	G3/8	7892 10 17	6	20	22.5	57	41	11	31	0.144		
	10	G1/2	7892 10 21	10	24	28	63	47	16	36	0.109		
	12	G1/2	7892 12 21	10	24	28	63	47	16	36	0.150		

7894 Piloted Non-Return Valve with Flow Regulator and Exhaust, Male BSPP Thread

	Technical polymer, nickel-plated brass, NBR		ØD	C		E	F1	F2	G	H	H1	H2	H3	L	L_{max}	L1	kg
	6	G1/8	7894 06 10	6	13	8	14	46	7	24	31	48.5	51	16	0.041		
	6	G1/4	7894 06 13	9	17	10	18.5	49	11	18	31	59.5	65	17	0.067		
	8	G1/8	7894 08 10	6	13	8	14	46	7	27	31	48.5	51	22	0.051		
	8	G1/4	7894 08 13	9	17	10	18.5	49	11	23	31	59.5	65	23	0.068		
	8	G3/8	7894 08 17	7	20	14	22.5	69	13	21	40	67.5	73	23	0.060		
	10	G3/8	7894 10 17	7	20	14	22.5	69	13	29	40	67.5	73	26	0.061		
	10	G1/2	7894 10 21	9	24	17	28	76	12.5	26	47	74	81	26	0.234		
	12	G1/2	7894 12 21	9	24	17	28	76	12.5	27	47	74	81	30	0.237		

3104 Unequal Tee

	Technical polymer, NBR		ØD	ØD1		G	H	L/2	kg
	6	4	3104 06 04			10.5	22.5	17.5	0.005
	8	4	3104 08 04			13.5	29	22.5	0.014
	10	4	3104 10 04			16	33	26	0.027
	12	4	3104 12 04			19	39	31	0.034

Model		Pilot and depilot threshold				
		2 bar	4 bar	6 bar	8 bar	10 bar
G1/8	Pilot Pressure	1.2	1.72	2.44	2.96	3.56
	Depilot Pressure	0.56	0.96	1.12	1.76	2.12
G1/4	Pilot Pressure	0.92	1.52	2.12	2.68	3.28
	Depilot Pressure	0.64	1.16	1.68	2.16	2.64
G3/8	Pilot Pressure	1.12	1.84	2.56	3.32	4.08
	Depilot Pressure	0.64	1.04	1.44	1.84	2.36
G1/2	Pilot Pressure	1.04	1.60	2.12	2.76	3.88
	Depilot Pressure	0.76	1.28	1.76	2.20	2.72

Maximum Flow at 6 bar (NI/min)	7894 06 10	7894 06 13	7894 08 10	7894 08 13	7894 08 17	7894 10 17	7894 10 21	7894 12 21
Direction of Adjustment	250	475	240	585	875	940	1535	1560
Return	365	620	355	815	1085	1205	1860	1940

Non-Return Valves

Non-return valves allow compressed air to flow in one direction and prevent it from flowing in the other. Fitted upstream of the circuit to be protected, they provide **total protection**.

Product Advantages

Variety of Applications | Wide range
 Push-in connection: ease of use
 Available in threaded or push-in version

Powerful Design | Lip seals for improved sealing performance
 Excellent vibration resistance
 Compact
 Lightweight
 Symbol showing the operating direction of flow
 Safe installation with colour codes:
 • green push-button: supply version
 • red push-button: exhaust version

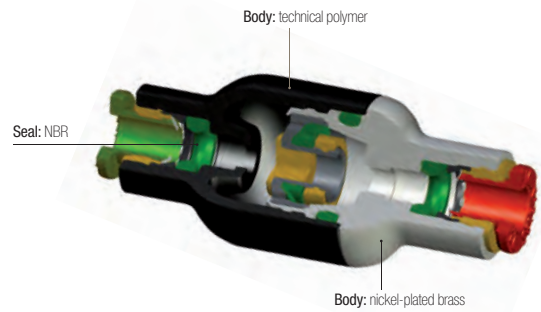


Applications
 Automotive Process
 Robotics
 Vacuum
 Textile
 Semi-Conductors
 Packaging
 Pneumatics

Technical Characteristics

Compatible Fluids	Compressed air	
Working Pressure	1 to 10 bar	
Working Temperature	0°C to +70°C	
Cracking Pressure	0.3 bar	
Flow Characteristics (NI/min)	Model	Flow at 6 bar
	4 mm	350
	6 mm	670
	8 mm	1080
	10 mm	2230
	12 mm	2300

Component Materials



Silicone-free

Regulations



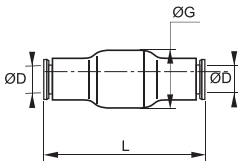
DI: 2002/95/EC (RoHS)
 RG: 1907/2006 (REACH)
 DI: 97/23/EC (PED)

Operation



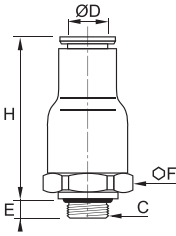
In-Line Version	Supply Version	Exhaust Version	Installation Diagram
<p>Non-return valve</p>	<p>Non-return valve</p> <p>Models 7984-7985</p>	<p>Non-return valve</p> <p>Models 7994-7995</p>	

Non-Return Valves



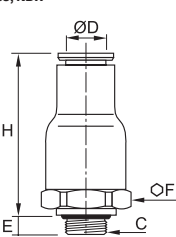
7996 In-Line Equal Non-Return Valve

		Technical polymer, nickel-plated brass, NBR 	ØD		G	L	kg
			4	7996 04 00	16	38.5	0.008
			6	7996 06 00	16	41	0.013
			8	7996 08 00	19	51.5	0.017
			10	7996 10 00	23	63.5	0.070
			12	7996 12 00	23	66.5	0.050



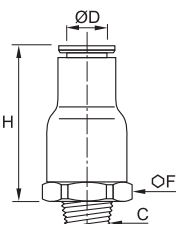
7984 In-Line Non-Return Valve, Supply, Male BSPP and Metric Thread

		Technical polymer, nickel-plated brass, NBR 	ØD	C		E	F	H	kg
			4	M5x0.8	7984 04 19	3	9	32	0.008
				G1/8	7984 04 10	5	16	28.5	0.015
			6	G1/8	7984 06 10	5	16	30.5	0.015
				G1/4	7984 06 13	5.5	16	30.5	0.015
			8	G1/8	7984 08 10	5	19	36	0.021
				G1/4	7984 08 13	5.5	19	36	0.023
			10	G3/8	7984 10 17	5.5	23	42	0.047
				G3/8	7984 12 17	5.5	23	42	0.010
			12	G1/2	7984 12 21	7.5	23	44	0.041

7994 In-Line Non-Return Valve, Exhaust, Male BSPP and Metric Thread



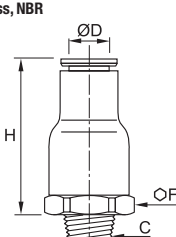
		Technical polymer, nickel-plated brass, NBR 	ØD	C		E	F	H	kg
			4	M5x0.8	7994 04 19	3	9	32	0.790
				G1/8	7994 04 10	5	16	28.5	0.018
			6	G1/8	7994 06 10	5	16	30.5	0.015
				G1/4	7994 06 13	5.5	16	30.5	0.015
			8	G1/8	7994 08 10	5	19	36	0.023
				G1/4	7994 08 13	5.5	19	36	0.023
			10	G3/8	7994 10 17	5.5	23	42	0.050
				G3/8	7994 12 17	5.5	23	42	0.043
			12	G1/2	7994 12 21	7.5	23	44	0.045

7985 In-Line Non-Return Valve, Supply, Male BSPT Thread

		Technical polymer, nickel-plated brass, NBR 	ØD	C		F	H	kg
			4	R1/8	7985 04 10	16	28.5	0.016
				R1/8	7985 06 10	16	30.5	0.016
			6	R1/4	7985 06 13	16	30.5	0.021
				R1/8	7985 08 10	19	36	0.022
			8	R1/4	7985 08 13	19	36	0.020
				R3/8	7985 10 17	23	42	0.049
			10	R3/8	7985 12 17	23	42	0.042
				R1/2	7985 12 21	23	44	0.048

Pre-coated thread

7995 In-Line Non-Return Valve, Exhaust, Male BSPT Thread

		Technical polymer, nickel-plated brass, NBR 	ØD	C		F	H	kg
			4	R1/8	7995 04 10	16	28.5	0.015
				R1/8	7995 06 10	16	30.5	0.016
			6	R1/4	7995 06 13	16	30.5	0.022
				R1/8	7995 08 10	19	36	0.022
			8	R1/4	7995 08 13	19	36	0.026
				R3/8	7995 10 17	23	42	0.048
			10	R3/8	7995 12 17	23	42	0.042
				R1/2	7995 12 21	23	44	0.048

Pre-coated thread

Nickel-Plated Brass Adjustable Non-Return Valves

These nickel-plated brass adjustable non-return valves, suitable for **harsh environments**, allow compressed air to flow in one direction and prevent flow in the other. This product incorporates **precise adjustment** of opening pressure for greater flexibility.

Product Advantages

- Robust** | Excellent resistance to abrasion and corrosion
Developed for the food process industry
- Optimised Inventory Management** | A single valve for multiple opening pressure settings
Limits the number of versions
Flexibility of use
- Protection & Safety** | Maintains downstream pressure if upstream pressure drops
Designed with locking nut to protect initial setting in the event of:
 - vibration
 - intensive use
 - accidental handling
 Adjustment and locking of the non-return valve cracking pressure with two different Allen keys prevents the settings from being accidentally changed
Smooth external profile to facilitate cleaning in situ
Maximum constant flow guaranteed whatever the setting of the cracking pressure



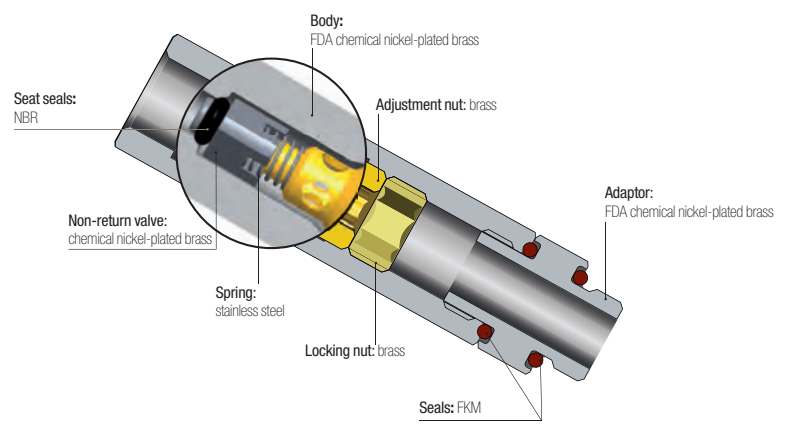
Applications

Printing
Machine Tools
Food Process
Petrochemical
Textile
Automotive Process
Chemical

Technical Characteristics

Compatible Fluids	Compressed air					
Working Pressure	0 to 12 bar					
Working Temperature	-20°C to +80°C					
Cracking Pressure	Threads	0 to 4 turns (values given as an example only)				
	M5x0.8 - G1/8 - G1/4	1 to 0.10 bar				
	G3/8	1 to 0.15 bar				
	G1/2	1 to 0.20 bar				
Max. Tightening Torques	Threads	M5x0.8	G1/8	G1/4	G3/8	G1/2
	daN.m	0.16	0.8	1.2	3	3.5

Component Materials



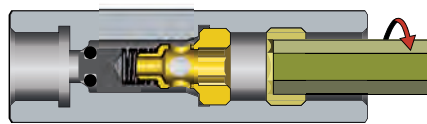
Silicone-free

Regulations

- DI: 2002/95/EC (RoHS)
- RG: External Components: 21CFR (FDA)
(seal: § 177.2600, nickel: §184.1537, grease: NSF H1)
- RG: 1935/2004 (external surface flow \geq 0.02 litre per hour)
- DI: 2006/42/EC (external surface Ra < 0.8 μ m)
- RG: 1907/2006 (REACH)

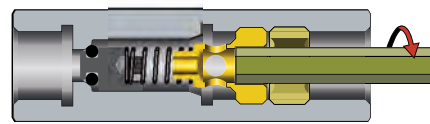
Operation

Step 1



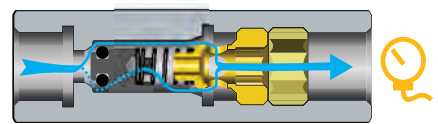
Unscrew the locking nut with an Allen key.

Step 2



Unscrew the adjustment nut with a smaller Allen key to adjust the cracking pressure. The number of turns adjusts the cracking pressure from 1 bar to 0.10 bar.


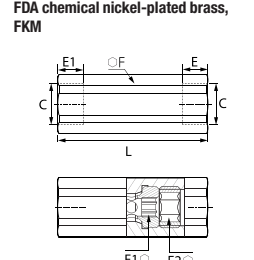

Step 3




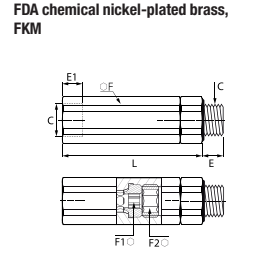

Tighten the locking nut with the Allen key to lock the cracking pressure setting. Then, control the pressure with a pressure gauge downstream.

Nickel-Plated Brass Adjustable Non-Return Valves


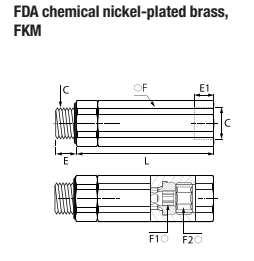

7930 Adjustable Check Valve, Double Female BSPP and Metric Thread

	FDA chemical nickel-plated brass, FKM 	C		E	E1	F	F1	F2	L	kg
		M5x0.8	7930 19 19	8	4	13	4	6	49	0.055
		G1/8	7930 10 10	8	6	13	4	6	45	0.033
		G1/4	7930 13 13	10	7.5	16	6	8	54	0.073
		G3/8	7930 17 17	11	8.5	20	8	10	61.5	0.163
		G1/2	7930 21 21	13	10	24	10	12	73	0.171

7931 Adjustable Check Valve Supply, Male/Female BSPP Thread

	FDA chemical nickel-plated brass, FKM 	C		E	E1	F	F1	F2	L	kg
		G1/8	7931 10 10	5.5	6	13	4	6	51.5	0.043
		G1/4	7931 13 13	6.5	7.5	16	6	8	61.5	0.208
		G3/8	7931 17 17	7.5	8.5	20	8	10	70	0.125
		G1/2	7931 21 21	9	10	24	10	12	82.5	0.212

7932 Adjustable Check Valve Exhaust, Male/Female BSPP Thread

	FDA chemical nickel-plated brass, FKM 	C		E	E1	F	F1	F2	L	kg
		G1/8	7932 10 10	5.5	8	13	4	6	51.5	0.009
		G1/4	7932 13 13	6.5	10	16	6	8	61.5	0.058
		G3/8	7932 17 17	7.5	11	20	8	10	70	0.123
		G1/2	7932 21 21	9	13	24	10	12	82.5	0.212

LIQUIfit® Non-Return Valves

LIQUIfit® non-return valves meet the requirements for conveying **beverages**. They allow flow in one direction and prevent any return flow. Fitted in the circuit, they provide **total protection**.

Product Advantages

Suitable for Beverage Applications

- Fully compatible for use with water, beverages and liquid foodstuffs (liquids and gas)
- Very low cracking threshold
- Excellent chemical compatibility
- Resistant to cleaning products
- Hygienic design with smooth surfaces
- Fluid direction indicated
- EPDM sealing technology

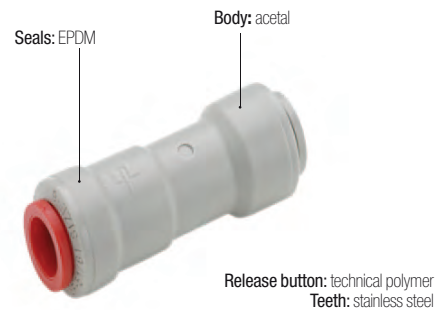


- Applications**
- Water Softeners
 - Water Treatment
 - Water Purification
 - Drinks Dispensers
 - Hot & Cold Water Systems

Technical Characteristics

Compatible Fluids	Water, beverages, liquid foodstuffs
Working Pressure	1 to 10 bar
Working Temperature	0°C to +65°C
Cracking Pressure	< 0.05 bar

Component Materials



Silicone-free

Regulations

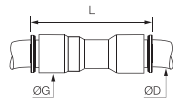
- DI: 2002/95/EC (RoHS), 2011/65/EC
- FDA: 21 CFR 177.1550
- NSF 51 (referenced material)
- NSF 61
- RG: 1907/2006 (REACH)

LIQUIfit® Non-Return Valves

7992 Single Non-Return Valve



Acetal, EPDM



ØD		G	L	kg
1/4	7992 56 00WP2	17	51	0.008
3/8	7992 60 00WP2	20	55	0.011

Associated Products

The full range of LIQUIfit® products can be found in this catalogue:

- Push-in fittings for metric and inch tubing (Chapter 1)
- Valves (Chapter 6)

To complement the LIQUIfit® range, Parker Legris Advanced PE tubing (Chapter 3) is suited to the most demanding environments, approved for permanent contact with beverage and food products, as well as for water treatment.

Stainless Steel Non-Return Valves

Stainless steel non-return valves are ideally suited to **harsh environments** and for conveying **many industrial fluids**. These products allow fluids to flow in one direction and prevent them from flowing in the other.

Product Advantages

Demanding Environments | Robust design
 Suitable for use with many chemicals or in corrosive environments
 Compatible with many fluids

Compact & Versatile | Reduced dimensions
 Smooth external surfaces contribute to equipment cleanliness
 Flow direction symbol protects against incorrect installation
 Hexagonal body to facilitate installation



Applications
 Pneumatics
 Machine Tools
 Food Process
 Printing
 Chemical
 Textile
 Automotive Process

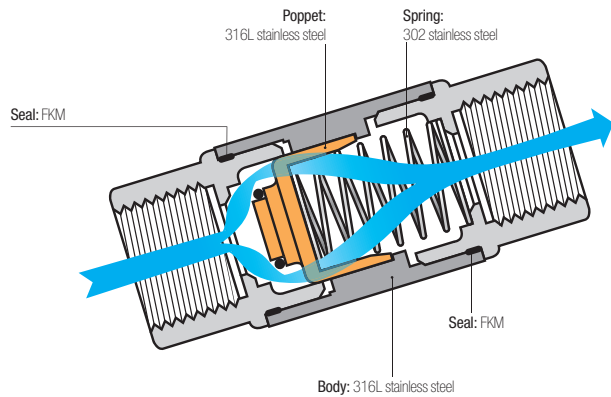
Technical Characteristics

Compatible Fluids	Many fluids
Working Pressure	0.5 to 40 bar
Working Temperature	-20°C to +180°C

Flow Characteristics	Threads	NI/min	Kv
	G1/8	18.88	1.60
	G1/4	19.91	1.69
	G3/8	35.54	3.01
	G1/2	36.50	3.10
	G3/4	65.86	5.59
G1	92.60	7.86	

Cracking Pressure	0.25 bar
--------------------------	----------

Component Materials




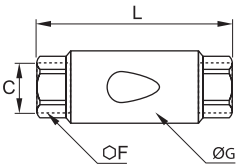

Silicone-free

Regulations


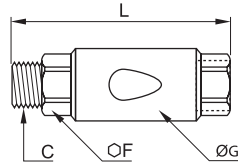

DI: 2002/95/EC (RoHS)
 RG: 1907/2006 (REACH)
 DI: 97/23/EC (PED)

Stainless Steel Non-Return Valves


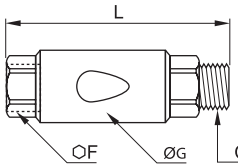

4890 Non-Return Valve, Female BSP Thread

	Stainless steel 316L, FKM 	C	DN		F	G	L	kg
		G1/8	10	4890 10 10	17	22	50	0.083
		G1/4	10	4890 13 13	17	22	50	0.074
		G3/8	15	4890 17 17	22	30	67	0.183
		G1/2	15	4890 21 21	24	30	71	0.209
		G3/4	20	4890 27 27	32	42	84	0.289
		G1	25	4890 34 34	38	42	90	0.519


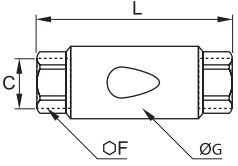

4891 Non-Return Valve, Supply, Male BSP Thread/Exhaust, Female BSP Thread

	Stainless steel 316L, FKM 	C	DN		F	G	L	kg
		G1/8	10	4891 10 10	17	22	56	0.100
		G1/4	10	4891 13 13	17	22	58	0.082
		G3/8	15	4891 17 17	22	30	75	0.189
		G1/2	15	4891 21 21	24	30	79	0.209
		G3/4	20	4891 27 27	32	42	84	0.300
		G1	25	4891 34 34	38	42	102	0.519

4892 Non-Return Valve, Supply, Female BSP Thread/Exhaust, Male BSP Thread

	Stainless steel 316L, FKM 	C	DN		F	G	L	kg
		G1/8	10	4892 10 10	17	22	56	0.100
		G1/4	10	4892 13 13	17	22	58	0.082
		G3/8	15	4892 17 17	22	30	75	0.191
		G1/2	15	4892 21 21	24	30	79	0.209
		G3/4	20	4892 27 27	32	42	84	0.300
		G1	25	4892 34 34	38	42	102	0.519

4895 Non-Return Valve, Female NPT Thread

	Stainless steel 316L, FKM 	C	DN		F	G	L	kg
		NPT1/8	10	4895 11 11	17	22	50	0.083
		NPT1/4	10	4895 14 14	17	22	54	0.079
		NPT3/8	15	4895 18 18	22	30	67	0.197
		NPT1/2	15	4895 22 22	24	30	77	0.194

Soft Start Fittings

These fittings protect your system by preventing sudden shocks. On start-up, they control the **pressure increase** in the downstream circuit; this helps **prevent the risk** of industrial accidents.

Product Advantages

Protection of Equipment & Personnel

Prevents the risk of damage after any stoppage which requires the system to be vented
Returns the control valve to its initial position in total safety
Adjustment of the pressurisation speed
Protects the adjustment mechanism using a recessed adjustment screw

Mounted on FRL

Models 7860 and 7861: yellow identification washer
Protection for the whole system
Simultaneous pressurisation speed of the whole system

Mounted on Control Valve

Models 7870 and 7871: black identification washer
Protection of individual circuits
Mounted on the control valve, it optimises the pressurisation speed of a specific cylinder



Applications
Pneumatic Systems
Robotics
Textile
Semi-Conductors
Packaging
Pneumatics

Technical Characteristics

Compatible Fluids	Compressed air	
Working Pressure	3 to 10 bar	
Working Temperature	-15°C to +60°C	

Max. Tightening Torques	Threads	daN.m	
	G1/4	1.3	
G3/8	1.5		
G1/2	1.8		

Flow Characteristics	Model	Flow at 6 bar	Kv
	7860 08 13	1500 NI/min	0.80
7860 10 13	2100 NI/min	1.20	
7860 10 17	2200 NI/min	1.30	
7860 12 17	3100 NI/min	1.00	
7860 12 21	3100 NI/min	1.00	
7861 13 13	2100 NI/min	1.20	
7861 17 17	3100 NI/min	1.00	
7861 21 21	3100 NI/min	1.00	
7870 08 13	1500 NI/min	0.80	
7870 10 13	2000 NI/min	1.15	
7870 10 17	2000 NI/min	1.15	
7871 13 13	2000 NI/min	1.15	
7871 17 17	2000 NI/min	1.15	

Component Materials

Internal seal: NBR

Adjustment screw: nickel-plated brass

Washer: technical polymer

Body: technical polymer or nickel-plated brass



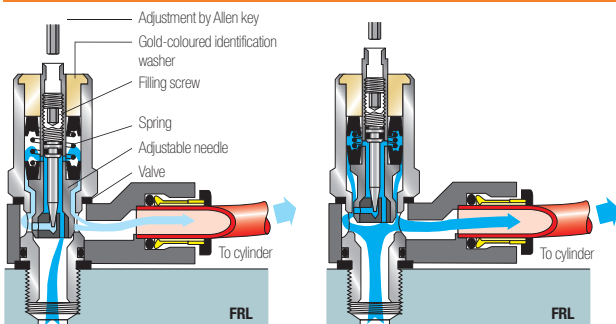
Silicone-free

Regulations

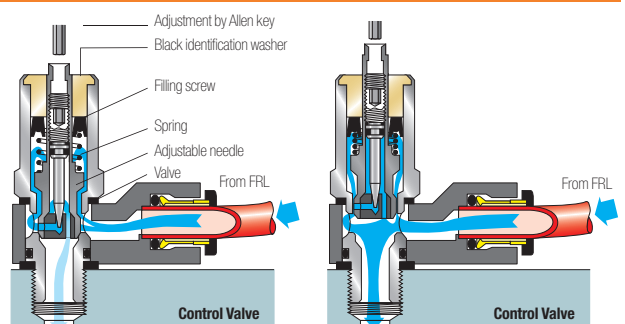
DI: 2002/95/CE (RoHS)
RG: 1907/2006 (REACH)
DI: 97/23/CE (PED)

Operation

Filter, Regulator, Lubricator


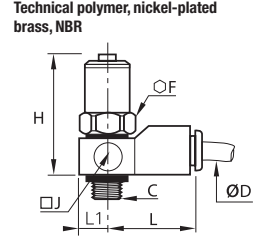


Control Valve


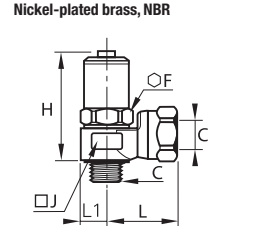


Soft Start Fittings


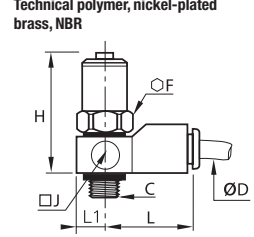
7860 Soft Start Fitting for Isolating Valve, Male BSPP Thread

		Technical polymer, nickel-plated brass, NBR	ØD	C		F	H _{min}	H _{max}	J	L	L1	kg
			8	G1/4	7860 08 13	17	54	61	20	35	10	0.064
			10	G1/4	7860 10 13	22	55	62	25	41	12.5	0.112
				G3/8	7860 10 17	22	55	62	25	41	12.5	0.115
			12	G3/8	7860 12 17	22	55	62	25	45	12.5	0.125
G1/2	7860 12 21	22		63.5	70.5	25	45	12.5	0.152			


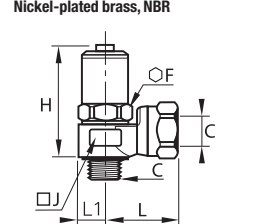
7861 Soft Start Fitting for Isolating Valve, Male/Female BSPP Thread

		Nickel-plated brass, NBR	C		F	H _{min}	H _{max}	J	L	L1	kg
			G1/4	7861 13 13	22	54	62	24	31	12	0.147
			G3/8	7861 17 17	22	55	62	24	31	12	0.139

7870 Soft Start Fitting for Control Valve, Male BSPP Thread

		Technical polymer, nickel-plated brass, NBR	ØD	C		F	H _{min}	H _{max}	J	L	L1	kg
			8	G1/4	7870 08 13	17	54	61	20	35	10	0.066
			10	G1/4	7870 10 13	22	55	62	25	41	12.5	0.114
				G3/8	7870 10 17	22	55	62	25	41	12.5	0.117

7871 Soft Start Fitting for Control Valve, Male/Female BSPP Thread

		Nickel-plated brass, NBR	C		F	H _{min}	H _{max}	J	L	L1	kg
			G1/4	7871 13 13	22	55	62	24	31	12	0.148
			G3/8	7871 17 17	22	55	62	24	31	12	0.141

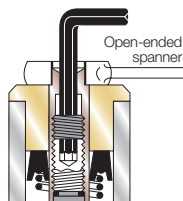
Adjustment of the Filling Screw

Adjusting the screw to regulate the flow of air optimises the time taken to pressurise depending on the air volume to be refilled and the system requirements.

To adjust:

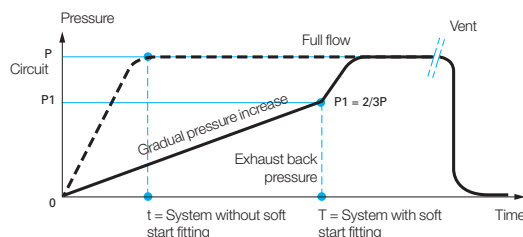
- immobilise the piston using a spanner
- adjust the screw with an Allen key
 - 1.5 mm key for 8 mm diameter
 - 2.5 mm key for 10 and 12 mm diameter

Max. tightening torque: 0.1 daN.m



Cylinder Pressure Cycle

When the downstream pressure reaches 2/3 of the supply pressure, full flow is automatically established



Pneumatic Sensor Fittings

The sensor detects the pressure drop when a cylinder reaches the end of its stroke. They produce a **pneumatic or electric output signal** when the pressure drop in the exhaust chamber of the cylinder goes below their back pressure threshold.

Product Advantages

- Easy-to-Use** | Suited to changes of series: no adjustment to position detectors is necessary
- With Pneumatic Output** | Totally pneumatic installation
2 possible installations:
 - Supplied with permanent pressure (P1); produces a pneumatic signal when the back pressure threshold is reached
 - Supplied from the control valve-cylinder circuit on the opposite side: no unexpected pneumatic signal (S) can appear during pressurisation due to the actuating pressure which supplies the sensor fitting (P1)
- With Electrical Output** | Combined electrical and pneumatic installation
Installation with continuous electrical supply only (BU)
Guarantees an electrical signal when the back pressure threshold is reached



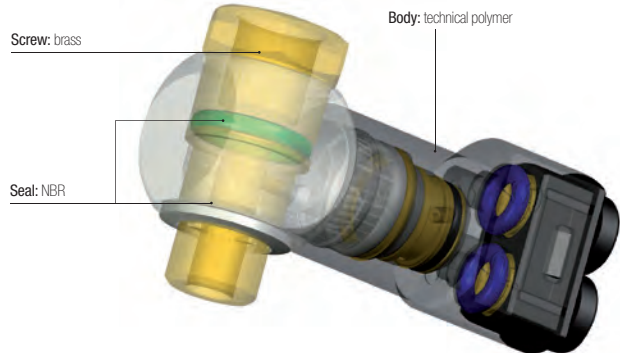
Applications

Robotics
Textile
Semi-Conductors
Packaging
Pneumatics

Technical Characteristics

Compatible Fluids	Compressed air
Working Pressure	3 to 8 bar
Working Temperature	-15°C to +60°C
Back Pressure	0.85 to 1 bar
Switching Time	Model 7818: 3 ms
Open/Closed Contact	Model 7828: 2A / 0-48 V 2A / 250 V 50 Hz

Component Materials



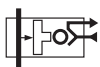
Silicone-free

Regulations

DI: 2002/95/EC (RoHS)
 RG: 1907/2006 (REACH)
 DI: 97/23/EC (PED)

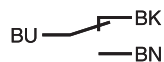
Operation

Pneumatic Installation Diagram



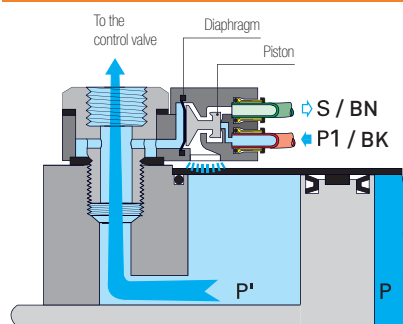
P': Exhaust back pressure
 P: Dynamic pressure
 P1: Sensor supply pressure
 S: Output signal

Electrical Installation Diagram

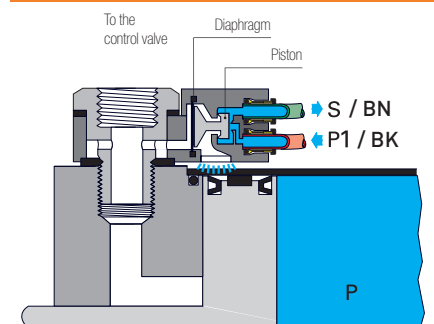


Connection via 3 core 0.5 mm² cable, 2 meters long.
 Contactor: 5A / 250 V ~ or 5W / 48V ==

Cylinder in Operation





Cylinder in Final Position

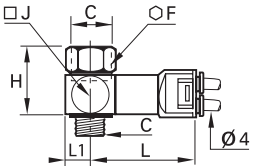


Pneumatic Sensor Fittings

7818 Pneumatic Sensor Fitting, Male BSPP and Metric Thread



Technical polymer, zamak, brass, NBR



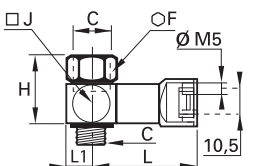
ØD	C		F	H	J	L	L1	kg
M5x0.8	7818 04 19*		8	16	11	43.5	5.5	0.025
G1/8	7818 04 10		14	23	16	44.5	8	0.043
G1/4	7818 04 13		17	28	19.5	46.5	10	0.061
G3/8	7818 04 17		22	29	23.5	49	12	0.083
G1/2	7818 04 21		27	30	31.5	52.5	16	0.125

* Bolt zinc passivated steel

7818 Pneumatic Sensor, Male/Female BSPP Thread






Technical polymer, zamak, brass, NBR

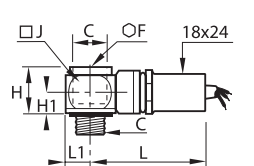


C		F	H	J	L	L1	kg
G1/8	7818 19 10	14	23	16	40.5	8	0.047
G1/4	7818 19 13	17	28	19.5	42.5	10	0.065

7828 Pneumatic/Electric Sensor, Male/Female BSPP and Metric Thread

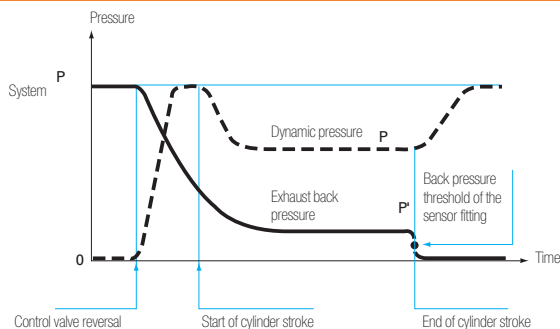



Technical polymer, brass, NBR



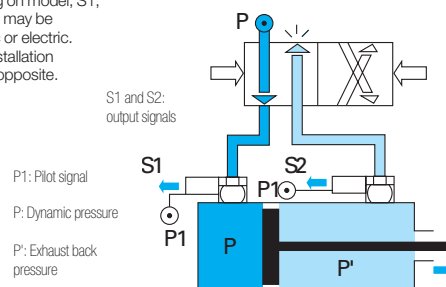
C		F	H	H1	J	L	L1	kg
M5x0.8	7828 00 19	8	20	10	11	49	5.5	0.120
G1/8	7828 00 10	6	20	10	16	52	8	0.131
G1/4	7828 00 13	8	20	10	21	54	10.5	0.145
G3/8	7828 00 17	10	22	12	28	57	14	0.182
G1/2	7828 00 21	12	26	14	33	58	16.5	0.206

Cylinder Pressure Cycle



Installation Diagram

Depending on model, S1, S2 and P1 may be pneumatic or electric. See the installation diagrams opposite.



Pressure Regulators

Parker Legris pressure regulators **stabilise at the maximum determined value** the pressure delivered to the pneumatic equipment, whatever the fluctuations of the pressure upstream.

Product Advantages

Ergonomics | Easy adjustment of the output pressure through the knurled screw
 Lockable adjustment possible
 Output pressure adjustment options marked on the screw

Energy Savings | Setting of the optimum pressure enables the equipment to function correctly
 Installation in a manifold allows optimum output pressures to be delivered to specific parts of the circuit
 Designed for applications where cylinder force needs to be controlled: marking, sleeving, crimping cylinders etc.



Applications
 Robotics
 Textile
 Semi-Conductors
 Packaging
 Pneumatics

Technical Characteristics

Compatible Fluids	Compressed air		
Working Pressure	Upstream pressure: 1 to 16 bar Downstream pressure: 1 to 8 bar		
Working Temperature	-10°C to +70°C		

Max. Tightening Torques	Threads	G1/8	G1/4	G3/8
	daN.m	0.4	0.5	0.6

Component Materials



Silicone-free

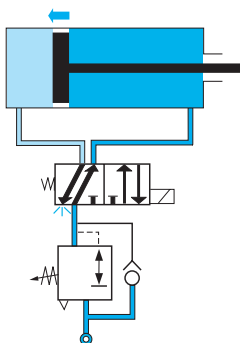
Regulations

DI: 2002/95/EC (RoHS)
 RG: 1907/2006 (REACH)
 DI: 97/23/EC (PED)

Operation

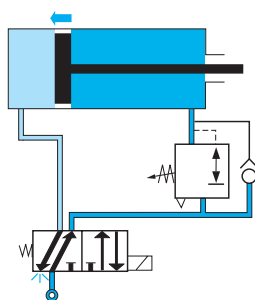
Mounting Upstream of the Control Valve

Adjustment of the piston feed pressure in both directions

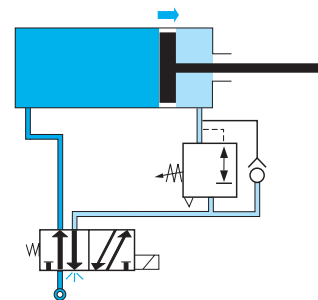


Mounting Downstream of the Control Valve

Phase 1: adjustment of the piston speed in a single direction



Phase 2: in return direction, pressure is supplied through the control valve

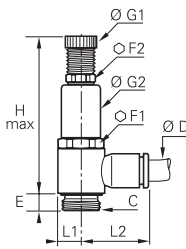


Pressure Regulators

7300 Pressure Regulator, Male BSPP Thread



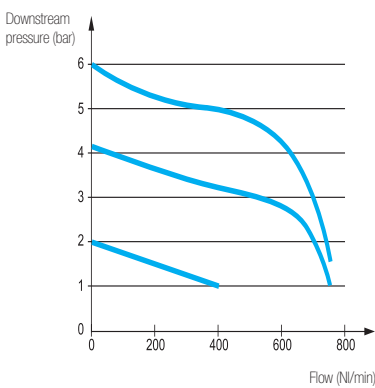
Technical polymer, nickel-plated brass, NBR



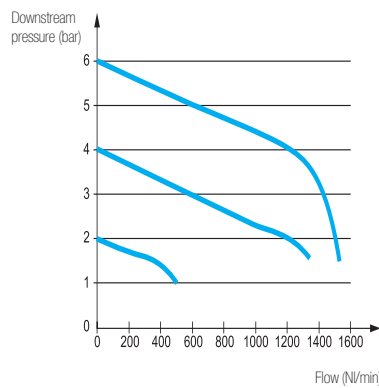
ØD	C		E	F1	F2	G1	G2	H max	L1	L2	kg
4	G1/8	7300 04 10	4.5	17	13	14	17	65	7	18.5	0.047
	G1/8	7300 06 10	4.5	17	13	14	17	65	7	20	0.047
6	G1/4	7300 06 13	7.5	17	13	14	17	74.5	9.5	22	0.065
	G1/8	7300 08 10	4.5	17	13	14	17	65	7	25	0.048
8	G1/4	7300 08 13	7.5	17	13	14	17	74.5	9.5	27	0.066
	G3/8	7300 08 17	8.5	22	17	18.5	22	84	11.5	28.5	0.121
10	G1/4	7300 10 13	7.5	17	13	14	17	74.5	9.5	29	0.067
	G3/8	7300 10 17	8.5	22	17	18.5	22	84	11.5	30.5	0.122

Flow Characteristics at 7 bar (Nl/min)

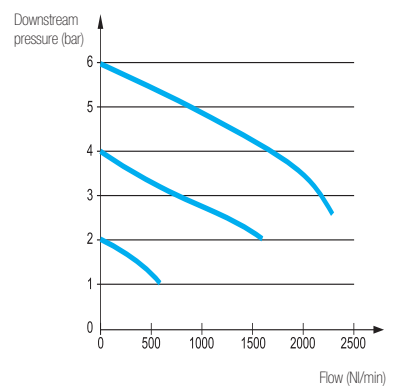
G1/8 Models



G1/4 Models



G3/8 Models



Pressure Reducers

Parker Legris pressure reducers are designed to **set the pressure** of a compressed air circuit to a determined value. They therefore enable **energy saving** by limiting the cylinder pressure.

Product Advantages

Design & Performance

- Optimisation of the pressure at the minimum values required to provide final force and energy consumption
- Manual adjustment protected by a plug
- Visual indication of the differential pressure by colour code

Two Models Available

- Banjo: fitted directly on the control valve or terminal block
- In-line: fitted in the pipework, between the control valve and cylinder



Applications
 Robotics
 Textile
 Semi-Conductors
 Packaging
 Pneumatics

Technical Characteristics

Compatible Fluids	Compressed air				
Working Pressure	1 to 8 bar				
Working Temperature	-15°C to +60°C				
Max. Tightening Torques for Models 7318 and 7471	Threads	G1/8	G1/4	G3/8	G1/2
	daN.m	0.8	1.2	3	3.5

Component Materials

Internal seals: NBR



Screw: nickel-plated brass

Sealing washer: technical polymer

Body:
 Models 7318-7471: zamak
 Models 7316-7416: nickel-plated, shot-blasted brass

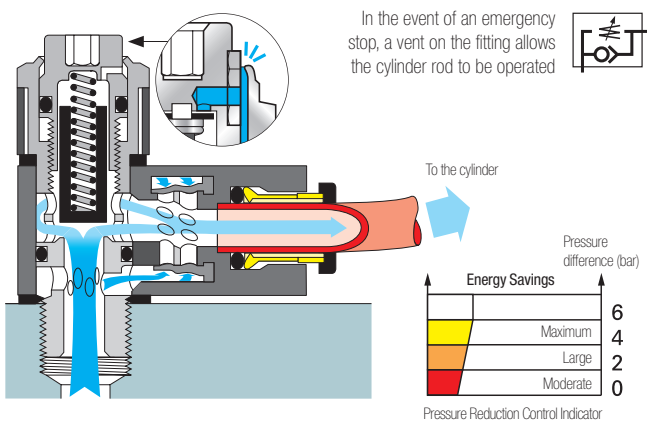
Silicone-free

Regulations

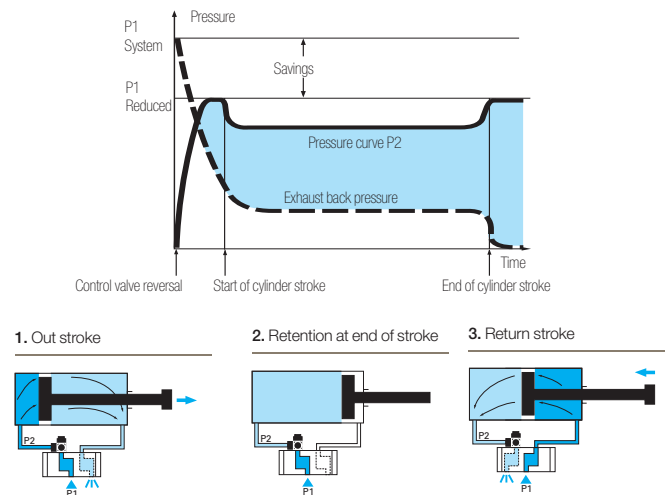
- DI: 2002/95/EC (RoHS)
- RG: 1907/2006 (REACH)
- DI: 97/23/EC (PED)

Operation

Installation Diagram

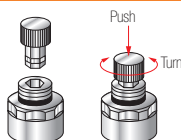


Cylinder Pressure Cycle

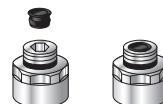


Manual Adjustment

To ease access to the adjustment, Parker Legris has designed a plug-in manual control system.



To prevent access to the setting mechanism, a sealing plug may be used.


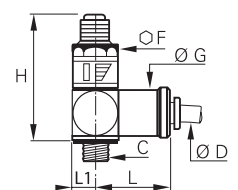



This may be removed if necessary as follows:
 1. Pierce the centre
 2. Remove the plug


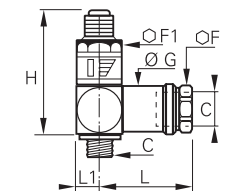



Pressure Reducers


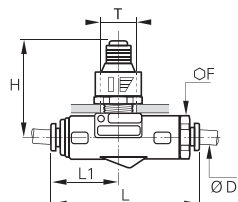

7318 Banjo Pressure Reducer, Male BSPP Thread

	Zamak, nickel-plated brass, NBR 	ØD C 	F	G	H_{min}	H_{max}	L	L1	kg
		6 G1/8 7318 06 10 G1/4 7318 06 13 8 G1/4 7318 08 13 G1/4 7318 10 13 10 G3/8 7318 10 17	19	20	49	57	43	10.5	0.137


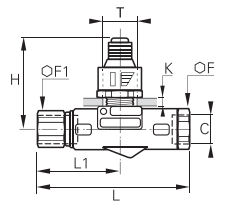

7471 Banjo Pressure Reducer, Male/Female BSPP Thread

	Zamak, nickel-plated brass, NBR 	C 	F	F1	G	H_{min}	H_{max}	L	L1	kg
		G1/8 7471 10 10 G1/4 7471 13 13 G3/8 7471 17 17 G1/2 7471 21 21	19	19	20	49	57	45	10.5	0.158


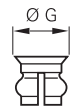

7316 In-Line Tube-to-Tube Pressure Reducer

	Nickel-plated brass, NBR 	ØD 	F	H_{min}	H_{max}	L	L1	ØT	kg
		6 7316 06 00 8 7316 08 00 10 7316 10 00	22	49	57	74	32	18.5	0.212


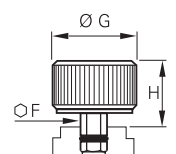

7416 In-Line Pressure Reducer, Female BSPP Thread

	Nickel-plated brass, NBR 	C 	F	F1	H_{min}	H_{max}	K	L	L1	ØT	kg
		G1/8 7416 10 10 G1/4 7416 13 13 G3/8 7416 17 17 G1/2 7416 21 21	17	19	49	57	4	74	35	18.5	0.212

7000 Sealing Plug for Pressure Reducer

	Technical polymer 		G	kg
		7000 00 01	8	0.001

7000 Manual Ratchet Control for Pressure Reducer

	Nickel-plated brass, NBR 		F	G	H	kg
		7000 00 00	6	22	15	0.040

Snap Fittings

The snap fittings enable a **circuit to be isolated** without the need to vent the complete system. They are designed to facilitate repeated connections and disconnections in total safety.



Product Advantages

Performance & Safety

- Partial venting of systems while work is carried out
- Energy and time saving during maintenance operations
- Protection of individuals by maintaining pressure if necessary
- Audible click indicates connection
- Circuit identification by coloured rings (on request)

- ### Applications
- Control Panels
 - Robotics
 - Semi-Conductors
 - Packaging
 - Pneumatics
 - Automotive Process

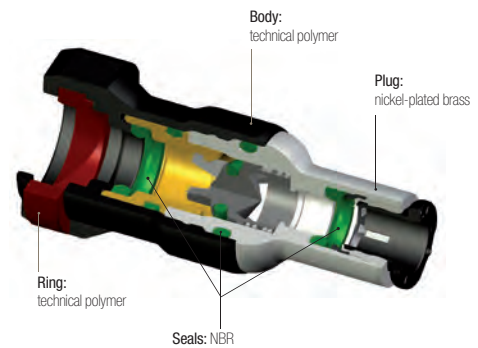
Technical Characteristics

Compatible Fluids	Compressed air
Working Pressure	0 to 10 bar
Working Temperature	-20°C to +80°C
Flow Characteristics at 6 bar	DN 5 mm: 1000 Nl/min DN 7 mm: 1900 Nl/min

Regulations

- DI: 2002/95/EC (RoHS)
- RG: 1907/2006 (REACH)
- DI: 97/23/EC (PED)

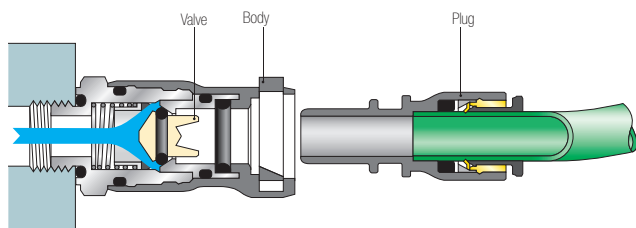
Component Materials



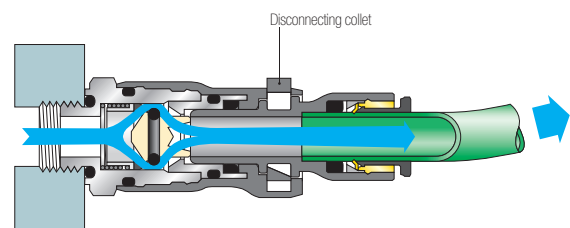
Silicone-free

Operation

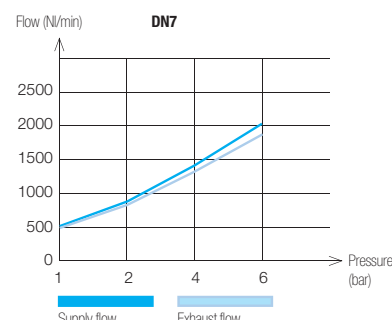
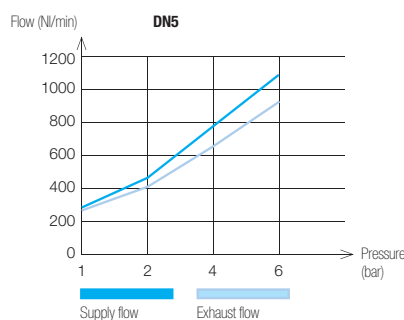
Circuit Closed



Circuit Open



Flow Characteristics - Pressure Drop

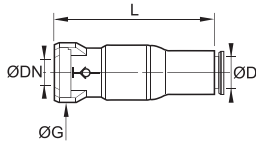


Snap Fittings

7926 Body with Push-In Connection



Technical polymer, nickel-plated brass, NBR

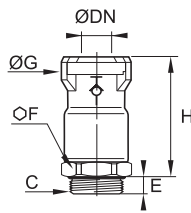


ØD	DN		G	L	kg
6	5	7926 05 06	18.5	44	0.020
8	5	7926 05 08	18.5	49	0.024
10	7.3	7926 07 10	22	58.5	0.044

7921 Body with Male BSPP Thread



Technical polymer, nickel-plated brass, NBR

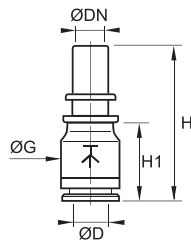


C	DN		E	F	G	H	kg
G1/8	5	7921 05 10	5.5	16	18.5	31.5	0.022
G1/4	5	7921 05 13	5.5	16	18.5	31.5	0.023
	7.3	7921 07 13	5.5	20	22	37.5	0.039
G3/8	7.3	7921 07 17	5.5	20	22	37.5	0.041

7960 Straight Probe, Push-In Connection



Technical polymer, NBR

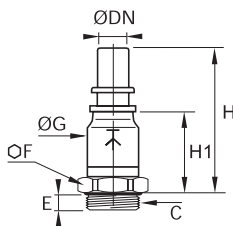


ØD	DN		G	H	H1	kg
6	5	7960 05 06	13.5	36.5	17.5	0.007
8	5	7960 05 08	13.5	37	18	0.003
10	7.3	7960 07 10	16	41	20.5	0.004

7961 Straight Probe, Male BSPP Thread



Technical polymer, nickel-plated brass, NBR



C	DN		E	F	G	H	H1	kg
G1/8	5	7961 05 10	5.5	13	13.5	46	27	0.017
	5	7961 05 13	5.5	16	13.5	46	27	0.019
	7.3	7961 07 13	5.5	16	16	51.5	31	0.025
G3/8	7.3	7961 07 17	5.5	20	16	51.5	31	0.034

Manually-Operated Valves

Manually-operated valves offer a **reliable** and **durable** system for opening and closing the circuit when the system has to be **switched frequently**. They provide a significant reduction in the time needed to work on pneumatic circuits.

Product Advantages

Manual Switch-Operated Valves

Downstream control supply provided by simply moving the lever
 2 models available to provide the best solution for the system:

- 3/2: opening, closing, venting
- 2/2: opening, closing

Compact and ergonomic (can be positioned through 360°)
 Push-in connections

Valves with Sliding Sleeve

Uni-directional use ensures the downstream circuit is vented
 Operated in the plane of the tube
 Lightweight due to the use of aluminium
 Ideal for complex installations in a restricted space
 Immediate identification of the venting system by the colour (red)



Applications

- Robotics
- Conveyors
- Textile
- Plastics Engineering
- Printing
- Pneumatics
- Packaging

Technical Characteristics

Compatible Fluids	Compressed air
Working Pressure	0 to 10 bar Model 0669: 0 to 16 bar
Working Temperature	-10°C to +80°C Model 0669: -5°C to +70°C

Component Materials

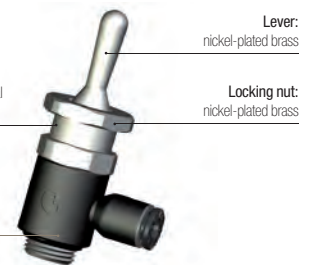
Seals: NBR

Bolt:

Manual switch-operated valve: nickel-plated brass with seal
 Sleeve valve: nickel-plated brass

Body:

Manual switch-operated valve: technical polymer
 Sleeve valve: nickel-plated brass



Silicone-free

Regulations

DI: 2002/95/EC (RoHS)
 RG: 1907/2006 (REACH)
 DI: 97/23/EC (PED)

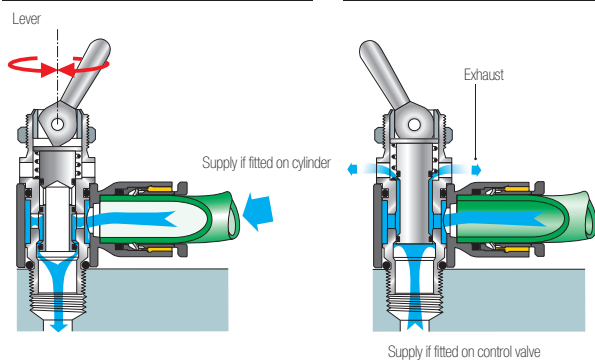
Operation

Switch-Operated Valves

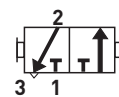


Open

Closed

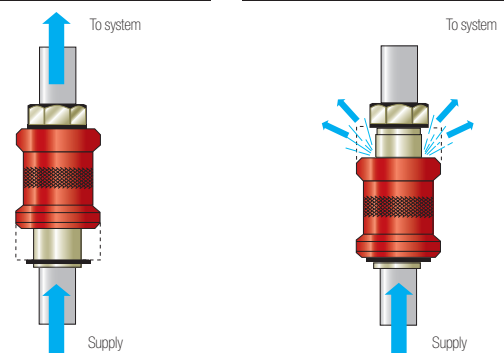


Sleeve Valves





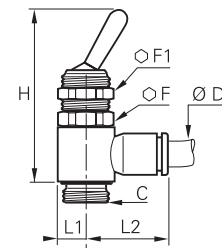
Open: downstream supply

Closed: downstream exhaust





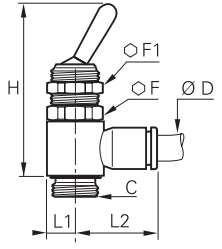
Manually-Operated Valves

7800 3/2 Manual Switch-Operated Valve, Supply, Male BSPP and Metric Thread



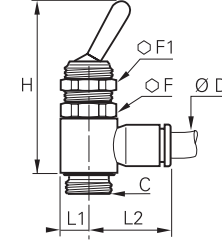
		<p>Technical polymer, nickel-plated brass, NBR</p> 	ØD	C		F	F1	H	L1	L2	kg	
			4	M5x0.8	7800 04 19	14	14	42	7	18.5	0.008	
				G1/8	7800 04 10	14	14	43	7	18.5	0.022	
				M5x0.8	7800 06 19	14	14	42	7	18.5	0.009	
				G1/8	7800 06 10	14	14	43	7	20	0.023	
				G1/4	7800 06 13	17	14	50.5	9	22	0.048	
				G1/8	7800 08 10	14	14	43	7	25	0.023	
				G1/4	7800 08 13	17	14	50.5	9	27	0.048	
				10	G1/4	7800 10 13	17	14	50.5	9	29	0.048

For part numbers 7800 04 19 and 7800 06 19, adaptor sealing is effected by a flat PTFE seal and tightening torque is maximum 0.16 daN.m.



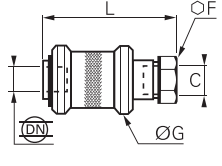
7801 3/2 Manual Switch-Operated Valve, Control, Male BSPP Thread

		<p>Technical polymer, nickel-plated brass, NBR</p> 	ØD	C		F	F1	H	L1	L2	kg	
			4	G1/8	7801 04 10	14	14	43	7	18.5	0.023	
				G1/8	7801 06 10	14	14	43	7	20	0.023	
				G1/4	7801 06 13	17	14	50.5	9	22	0.048	
				G1/8	7801 08 10	14	14	43	7	25	0.026	
				G1/4	7801 08 13	17	14	50.5	9	27	0.049	
				10	G1/4	7801 10 13	17	14	50.5	9	29	0.051

7802 2/2 Manual Switch-Operated Valve, Male BSPP Thread

		<p>Technical polymer, nickel-plated brass, NBR</p> 	ØD	C		F	F1	H	L1	L2	kg	
			4	G1/8	7802 04 10	14	14	43	7	18.5	0.023	
				G1/8	7802 06 10	14	14	43	7	20	0.024	
				G1/4	7802 06 13	17	14	50.5	9	22	0.050	
				G1/8	7802 08 10	14	14	43	7	25	0.024	
				G1/4	7802 08 13	17	14	50.5	9	27	0.052	
				10	G1/4	7802 10 13	17	14	50.5	9	29	0.052

0669 3/2 Sleeve Valve, Female BSPP and Metric Thread

		<p>Nickel-plated brass, aluminium, NBR</p> 	C	DN		F	G	L	kg
			M5x0.8	2.5	0669 02 19	10	14	30.5	0.012
			G1/8	4	0669 04 10	14	25	48	0.050
			G1/4	7	0669 07 13	19	30	58	0.096
			G3/8	10	0669 10 17	22	35	68	0.154
			G1/2	14	0669 14 21	27	40	75	0.210
			G3/4	19	0669 19 27	32	50	83	0.324

Metal Quick Exhaust Valves

This range of metal quick exhaust valves is offered in nickel-plated brass, aluminium and stainless steel. These valves, which are suitable for **any environment**, increase the **return speed** of the cylinder rod by allowing the exhaust to pass directly to atmosphere.

Product Advantages

Time Saving & Compact

Reduction in cycle times: return speed improved
 Dimensions optimised for space reduction
 Exhaust silencer incorporated on some models
 Excellent exhaust capacity
 Robust

Nickel-Plated Brass or Stainless Steel

Ideal for applications in restrictive environments
 Orientation as required
 Many installation options and choice of silencer
 Designed without retention areas to optimise frequent cleaning operations (stainless steel)

Aluminium

Protection of individuals through low noise emissions
 Lightweight and robust
 Silencer integrated for greater compactness

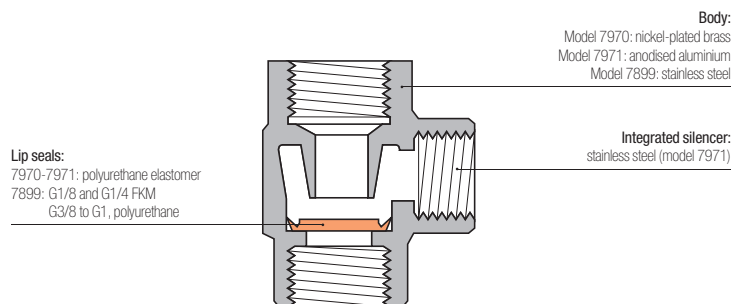


Applications
 Robotics
 Conveyors
 Textile
 Plastics Engineering
 Printing
 Pneumatics
 Packaging

Technical Characteristics

Compatible Fluids	Compressed air
Working Pressure	7970: 0.7 to 10 bar 7971 and 7899: 2 to 10 bar
Working Temperature	7970: -20°C to +70°C 7971: -10°C to +70°C 7899: Threads G1/8 and G1/4: -10°C to +120°C Threads G3/8 to G1: -20°C to +180°C

Component Materials



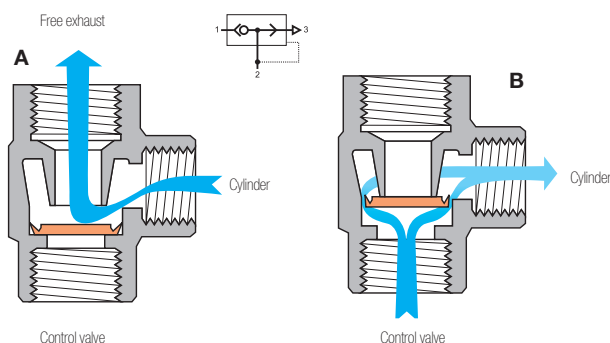
Silicone-free

Regulations

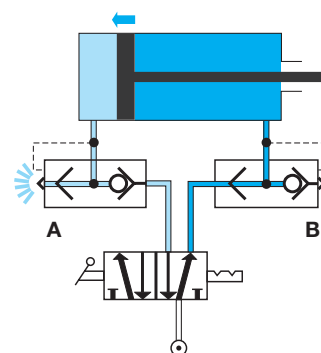
DI: 2002/95/EC (RoHS)
 RG: 1907/2006 (REACH)
 DI: 97/23/EC (PED)

Operation

Mounted on Cylinder





Installation Diagram

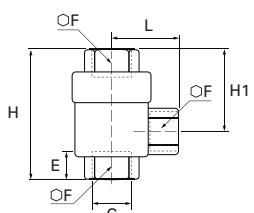


Metal Quick Exhaust Valves

7970 Elbow Quick Exhaust Valve, Female BSPP and Metric Thread



Nickel-plated brass



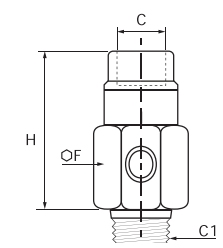
C		E	F	H	H1	L	kg
M5x0.8	7970 19 19	5	10	24.8	15.6	4	0.028
G1/8	7970 10 10	7.5	14	42	28	8	0.084
G1/4	7970 13 13	11	19	53	34.5	11	0.146
G3/8	7970 17 17	12	21	58	36	12	0.149
G1/2	7970 21 21	14	26	71	44	14	0.314
G3/4	7970 27 27	16	32	86	52	18	0.449
G1	7970 34 34	19	38	94	56	19	0.530

Noise level:
 7971 10 10 : 70 dBa
 7971 13 13 : 70 dBa
 7971 17 17 : 72 dBa
 7971 21 21 : 88 dBa

7971 Elbow Quick Exhaust Valve, Male BSPT/Female BSPP Thread






Treated aluminium

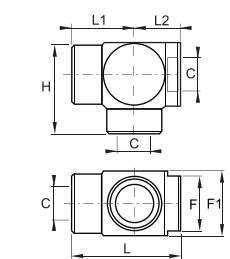


C	C1		F	H	kg
G1/8	R1/8	7971 10 10	18	51	0.013
G1/4	R1/4	7971 13 13	18	49	0.018
G3/8	R3/8	7971 17 17	27	56	0.048
G1/2	R1/2	7971 21 21	34	70	0.086

7899 Quick Exhaust Valve, Female BSPP Thread

Stainless steel 316L



C	DN		F	F1	H	L	L1	L2	kg
G1/8	7	7899 00 10	17	22	31.5	37.5	21	16.5	0.097
G1/4	7	7899 00 13	17	22	31.5	37.5	21	16.5	0.083
G3/8	9	7899 00 17	22	26	37	44.5	25.5	19	0.139
G1/2	12	7899 00 21	27	32	45	54	31	23	0.240
G3/4	18	7899 00 27	38	46	65	79	44	35	0.795
G1	18	7899 00 34	38	46	65	79	44	35	0.674

To complement our exhaust valves 7970 and 7899, you will find a full range of silencers on the following pages.

Silencers

Silencers are designed for installation on exhaust circuits **to reduce the noise levels** of equipment while operating, thus improving user comfort.

Product Advantages

Variety of Applications

- 2 versions incorporating flow control regulation
- Extremely compact models available
- Polyethylene: excellent balance between exhaust flow rate and noise reduction
- Sintered bronze: robust and economic
- 316L stainless steel: increased chemical resistance and mechanical strength



Applications
 Robotics
 Textile
 Semi-Conductors
 Packaging
 Pneumatics

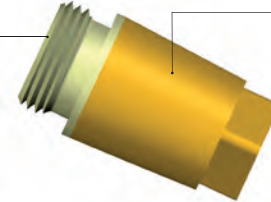
Technical Characteristics

Compatible Fluids	Compressed air
Working Pressure	Polyethylene: 0 to 10 bar Sintered bronze: 0 to 12 bar 316L stainless steel: 0 to 12 bar
Working Temperature	Polyethylene: -10°C to +80°C Sintered bronze: -20°C to +150°C 316L stainless steel: -20°C to +180°C

Component Materials

Body:
 brass (0670-0673-0675-0671-0677-0672)
 polymer (0674-0676)
 stainless steel (0682-0683)

Silencer:
 sintered bronze (0670-0673-0675-0671-0677-0672)
 polymer (0674-0676)
 316L stainless steel (0682-0683)



Silicone-free

Regulations

- DI: 2002/95/EC (RoHS)
- RG: 1907/2006 (REACH)
- DI: 97/23/EC (PED)
- DI: 2003/10/EC (Noise Directive)
- Requirement to use ear protection if exposure > 8 hours (85 dBA)
- RG: 1910.95(b) (OSHA)
- Requirement to use ear protection if exposure > 8 hours (90 dBA)


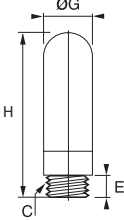

Flow and Noise Levels for Silencers 0672 and 0676

0672	Number of Turns						Noise Level in dBA at 6 bar and 350 NI/min
	0	1	2	3	4	5	
0672 00 10	0	200	600	740	-	-	81
0672 00 13	0	300	650	1280	-	-	82
0672 00 17	0	450	950	1300	1500	-	83
0672 00 21	0	830	1430	1800	2100	2220	83


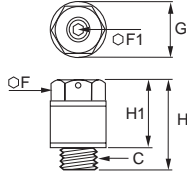

0676	Number of Turns										Noise Level in dBA at 6 bar and 350 NI/min
	0	1	2	3	4	5	6	7	8	9	
0676 00 10	0	30	90	210	335	370	390	390	395	395	82
0676 00 13	0	22	25	50	340	750	940	980	1000	1025	84
0676 00 19	0	22	69	97	125	143	-	-	-	-	81
0676 00 17	0	518	1147	1716	2153	2571	2823	2930	-	-	85
0676 00 21		814	1849	2880	4087	5044	5236	-	-	-	86

Silencers


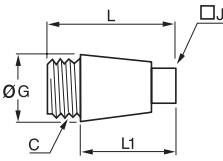

0674 Polymer Silencer, Male BSPP and Metric Thread

	<p>Technical polymer</p> 	<p>C</p> 	E	G	H	kg																																								
		<table border="1"> <tr><td>M5x0.8</td><td>0674 00 19</td><td>4</td><td>6.5</td><td>23</td><td>0.003</td></tr> <tr><td>G1/8</td><td>0674 00 10</td><td>6</td><td>12.5</td><td>34</td><td>0.002</td></tr> <tr><td>G1/4</td><td>0674 00 13</td><td>7</td><td>15.5</td><td>42.5</td><td>0.003</td></tr> <tr><td>G3/8</td><td>0674 00 17</td><td>11.5</td><td>18.5</td><td>67.5</td><td>0.007</td></tr> <tr><td>G1/2</td><td>0674 00 21</td><td>11</td><td>23.5</td><td>78</td><td>0.010</td></tr> <tr><td>G3/4</td><td>0674 00 27</td><td>15.5</td><td>38.5</td><td>131</td><td>0.035</td></tr> <tr><td>G1</td><td>0674 00 34</td><td>19.5</td><td>49</td><td>160</td><td>0.056</td></tr> </table>	M5x0.8	0674 00 19	4	6.5	23	0.003	G1/8	0674 00 10	6	12.5	34	0.002	G1/4	0674 00 13	7	15.5	42.5	0.003	G3/8	0674 00 17	11.5	18.5	67.5	0.007	G1/2	0674 00 21	11	23.5	78	0.010	G3/4	0674 00 27	15.5	38.5	131	0.035	G1	0674 00 34	19.5	49	160	0.056		
M5x0.8	0674 00 19	4	6.5	23	0.003																																									
G1/8	0674 00 10	6	12.5	34	0.002																																									
G1/4	0674 00 13	7	15.5	42.5	0.003																																									
G3/8	0674 00 17	11.5	18.5	67.5	0.007																																									
G1/2	0674 00 21	11	23.5	78	0.010																																									
G3/4	0674 00 27	15.5	38.5	131	0.035																																									
G1	0674 00 34	19.5	49	160	0.056																																									


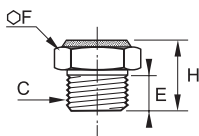

0676 Flow Control Polymer Silencer, Male BSPP and Metric Thread

	<p>Technical polymer</p> 	<p>C</p> 	F	F1	G	H	H1	kg																																					
		<table border="1"> <tr><td>M5x0.8</td><td>0676 00 19</td><td>8</td><td>1.5</td><td>9.2</td><td>16</td><td>11</td><td>0.008</td></tr> <tr><td>G1/8</td><td>0676 00 10</td><td>13</td><td>2.5</td><td>15</td><td>20.5</td><td>14.5</td><td>0.003</td></tr> <tr><td>G1/4</td><td>0676 00 13</td><td>15</td><td>4</td><td>18</td><td>29</td><td>22</td><td>0.007</td></tr> <tr><td>G3/8</td><td>0676 00 17</td><td>20</td><td>6</td><td>24</td><td>38</td><td>30</td><td>0.018</td></tr> <tr><td>G1/2</td><td>0676 00 21</td><td>25</td><td>8</td><td>30</td><td>50</td><td>40</td><td>0.045</td></tr> </table>	M5x0.8	0676 00 19	8	1.5	9.2	16	11	0.008	G1/8	0676 00 10	13	2.5	15	20.5	14.5	0.003	G1/4	0676 00 13	15	4	18	29	22	0.007	G3/8	0676 00 17	20	6	24	38	30	0.018	G1/2	0676 00 21	25	8	30	50	40	0.045			
M5x0.8	0676 00 19	8	1.5	9.2	16	11	0.008																																						
G1/8	0676 00 10	13	2.5	15	20.5	14.5	0.003																																						
G1/4	0676 00 13	15	4	18	29	22	0.007																																						
G3/8	0676 00 17	20	6	24	38	30	0.018																																						
G1/2	0676 00 21	25	8	30	50	40	0.045																																						


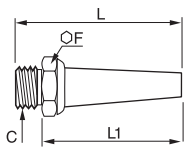

0670 Threaded Silencer, Male BSPP Thread

	<p>Sintered bronze, brass</p> 	<p>C</p> 	G	J	L	L1	kg																																							
		<table border="1"> <tr><td>G1/8</td><td>0670 00 10</td><td>12</td><td>7</td><td>22</td><td>17</td><td>0.007</td></tr> <tr><td>G1/4</td><td>0670 00 13</td><td>15</td><td>9</td><td>27</td><td>21</td><td>0.015</td></tr> <tr><td>G3/8</td><td>0670 00 17</td><td>19</td><td>11</td><td>35</td><td>28</td><td>0.028</td></tr> <tr><td>G1/2</td><td>0670 00 21</td><td>23</td><td>13</td><td>43</td><td>34</td><td>0.049</td></tr> <tr><td>G3/4</td><td>0670 00 27</td><td>30</td><td>17</td><td>55</td><td>45</td><td>0.091</td></tr> <tr><td>G1</td><td>0670 00 34</td><td>37</td><td>21</td><td>65</td><td>53</td><td>0.152</td></tr> </table>	G1/8	0670 00 10	12	7	22	17	0.007	G1/4	0670 00 13	15	9	27	21	0.015	G3/8	0670 00 17	19	11	35	28	0.028	G1/2	0670 00 21	23	13	43	34	0.049	G3/4	0670 00 27	30	17	55	45	0.091	G1	0670 00 34	37	21	65	53	0.152		
G1/8	0670 00 10	12	7	22	17	0.007																																								
G1/4	0670 00 13	15	9	27	21	0.015																																								
G3/8	0670 00 17	19	11	35	28	0.028																																								
G1/2	0670 00 21	23	13	43	34	0.049																																								
G3/4	0670 00 27	30	17	55	45	0.091																																								
G1	0670 00 34	37	21	65	53	0.152																																								

0673 Compact Silencer, Male BSPP and Metric Thread


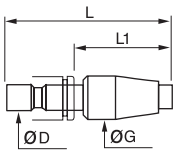

	<p>Sintered bronze, brass</p> 	<p>C</p> 	E	F	H	kg																											
		<table border="1"> <tr><td>M5x0.8</td><td>0673 00 19</td><td>4</td><td>7</td><td>8</td><td>0.001</td></tr> <tr><td>G1/8</td><td>0673 00 10</td><td>8</td><td>14</td><td>14</td><td>0.008</td></tr> <tr><td>G1/4</td><td>0673 00 13</td><td>8</td><td>17</td><td>14</td><td>0.012</td></tr> <tr><td>G3/8</td><td>0673 00 17</td><td>10</td><td>22</td><td>18</td><td>0.020</td></tr> <tr><td>G1/2</td><td>0673 00 21</td><td>12</td><td>27</td><td>21</td><td>0.042</td></tr> </table>	M5x0.8	0673 00 19	4	7	8	0.001	G1/8	0673 00 10	8	14	14	0.008	G1/4	0673 00 13	8	17	14	0.012	G3/8	0673 00 17	10	22	18	0.020	G1/2	0673 00 21	12	27	21	0.042	
M5x0.8	0673 00 19	4	7	8	0.001																												
G1/8	0673 00 10	8	14	14	0.008																												
G1/4	0673 00 13	8	17	14	0.012																												
G3/8	0673 00 17	10	22	18	0.020																												
G1/2	0673 00 21	12	27	21	0.042																												

0675 Threaded Silencer, Male BSPP and Metric Thread


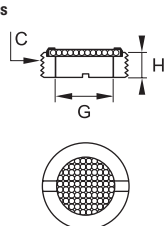

	<p>Sintered bronze, brass</p> 	<p>C</p> 	F	L	L1	kg																																	
		<table border="1"> <tr><td>M5x0.8</td><td>0675 00 19</td><td>7</td><td>16</td><td>12</td><td>0.002</td></tr> <tr><td>M7x1</td><td>0675 00 55</td><td>11</td><td>25</td><td>19</td><td>0.005</td></tr> <tr><td>G1/8</td><td>0675 00 10</td><td>14</td><td>42</td><td>34</td><td>0.014</td></tr> <tr><td>G1/4</td><td>0675 00 13</td><td>17</td><td>52</td><td>44</td><td>0.022</td></tr> <tr><td>G3/8</td><td>0675 00 17</td><td>22</td><td>54</td><td>44</td><td>0.037</td></tr> <tr><td>G1/2</td><td>0675 00 21</td><td>27</td><td>65</td><td>53</td><td>0.072</td></tr> </table>	M5x0.8	0675 00 19	7	16	12	0.002	M7x1	0675 00 55	11	25	19	0.005	G1/8	0675 00 10	14	42	34	0.014	G1/4	0675 00 13	17	52	44	0.022	G3/8	0675 00 17	22	54	44	0.037	G1/2	0675 00 21	27	65	53	0.072	
M5x0.8	0675 00 19	7	16	12	0.002																																		
M7x1	0675 00 55	11	25	19	0.005																																		
G1/8	0675 00 10	14	42	34	0.014																																		
G1/4	0675 00 13	17	52	44	0.022																																		
G3/8	0675 00 17	22	54	44	0.037																																		
G1/2	0675 00 21	27	65	53	0.072																																		

Silencers


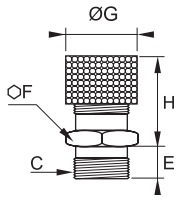

0671 Push-In Silencer

	Sintered bronze, nickel-plated brass 	ØD		G	L	L1	kg
		4	0671 04 00	13	41.5	24.5	0.015
		6	0671 06 00	15	48	29	0.024
		8	0671 08 00	15	49.5	29.5	0.025
		10	0671 10 00	19.5	68	43.5	0.052
		12	0671 12 00	20	68.5	43	0.052


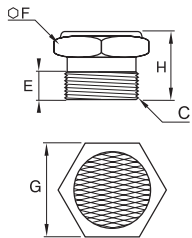

0677 Miniature Silencer, Male BSPP Thread

	Brass 	C		G	H	kg
		G1/8	0677 00 10	6	6	0.002
		G1/4	0677 00 13	8	6	0.003
		G3/8	0677 00 17	11	7	0.006
		G1/2	0677 00 21	14	8	0.010
		G3/4	0677 00 27	19	11	0.019
		G1	0677 00 34	25	10	0.025


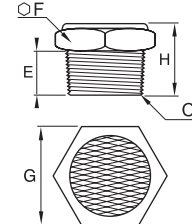

0672 Flow Control Silencer, Male BSPP Thread

	Sintered bronze, nickel-plated brass 	C		E	F	G	H_{min}	H_{max}	kg
		G1/8	0672 00 10	8	14	14	17	21	0.017
		G1/4	0672 00 13	8	17	17	20	24	0.029
		G3/8	0672 00 17	10	22	22	20	28	0.058
		G1/2	0672 00 21	12	27	27	28	37	0.094

0682 Compact Silencer, Male BSPP Thread

	Stainless steel 316L 	C		E	F	G	H	kg
		G1/8	0682 00 10	8	7	14	15	0.007
		G1/4	0682 00 13	8	7	17	15	0.011
		G3/8	0682 00 17	10	8	22	18	0.019
		G1/2	0682 00 21	12	10	27	22	0.038
		G3/4	0682 00 27	15	12	32	27	0.063
		G1	0682 00 34	18	14	38	32	0.117

0683 Compact Silencer, Male NPT Thread

	Stainless steel 316L 	C		E	F	G	H	kg
		NPT1/8	0683 00 11	7	7	14	14	0.007
		NPT1/4	0683 00 14	11	7	17	18	0.014
		NPT3/8	0683 00 18	11	8	22	19	0.021
		NPT1/2	0683 00 22	15	10	27	25	0.043

Compression Fittings

Brass Compression Fittings

Stainless Steel Compression Fittings

PL Nickel-Plated Brass Spigot Fittings



PARKER LEGRIS Industrial Connector Systems

Products are available from

MARYLAND METRICS

P.O. Box 261 Owings Mills, MD 21117 USA email: sales@mdmetric.com

ph: (410)358-3130 (800)638-1830 fx: (410)358-3142 (800)872-9329

web: http://mdmetric.com RFQ form: http://mdmetric.com/rfq.htm

How to order: Please preface each PARKER LEGRIS Catalog part number with 'R053-' Example: R053-3175 04 10



Compression Fittings

Brass Compression Fittings (P. 5-5)



Fluids: compressed air, non-corrosive industrial fluids
Materials: forged or machined brass
Pressure: 550 bar
Temperature: -40°C to +250°C
Ø metric: 4 mm to 28 mm

Stainless Steel Compression Fittings (P. 5-31)



Fluids: compressed air, coolants, industrial and corrosive fluids
Materials: 316L stainless steel
Pressure: 400 bar
Temperature: -40°C to +250°C
Ø metric: 6 mm to 16 mm

PL Nickel-Plated Brass Spigot Fittings (P. 5-41)



Fluids: compressed air, compatible industrial fluids
Materials: forged or machined nickel-plated brass
Pressure: 40 bar
Temperature: -40°C to +100°C
Ø metric: 4 mm to 14 mm

Compression Fitting Part Numbers

0105 14 27 99

Item Type	Ø	Thread	Suffix
01XX: brass 18XX: stainless steel	04 = 4 mm 06 = 6 mm ... 20 = 20 mm 28 = 28 mm	10 = 1/8 13 = 1/4 ... 21 = 1/2 27 = 3/4	39: bonded seal 40: treated steel 60: nut 70: polymer nut 99: chemical nickel

PL Fitting Part Numbers

F3BPL 8/10 -1/4

Item Type	Ø	Thread
FBPL F3BPL HBPL WBPL ...	2.7/4 4/6 6/8 7.5/10 8/10 10/12 11/14	BSPT & NPT: 1/8 1/4 3/8 ... Metric: M10 M12

Brass Compression Fitting Range

Brass Fittings

Stud Fittings

- | | | | | | | | |
|---------------------------------|--------------------------------|---|--------------------------------------|------------------------------------|----------------------------------|----------------------------------|---------------------------------|
| 0105
BSPT
Page 5-9 | 0105
NPT
Page 5-9 | 0101
BSPP/Metric
Page 5-10 | 0101..39
BSPP
Page 5-10 | 0101
Metric
Page 5-11 | 0114
BSPP
Page 5-11 | 0109
BSPT
Page 5-12 | 0109
NPT
Page 5-12 |
|---------------------------------|--------------------------------|---|--------------------------------------|------------------------------------|----------------------------------|----------------------------------|---------------------------------|



- | | | | | | | |
|----------------------------------|----------------------------------|----------------------------------|----------------------------------|--------------------------------------|----------------------------------|--------------------------------------|
| 0199
BSPP
Page 5-12 | 0108
BSPT
Page 5-13 | 0103
BSPT
Page 5-13 | 0118
BSPP
Page 5-14 | 0118..39
BSPP
Page 5-14 | 0119
BSPP
Page 5-15 | 0119..39
BSPP
Page 5-15 |
|----------------------------------|----------------------------------|----------------------------------|----------------------------------|--------------------------------------|----------------------------------|--------------------------------------|



Tube-to-Tube Fittings

- | | | | | | | |
|--------------------------|--------------------------|--------------------------|--------------------------|--------------------------|--------------------------|--------------------------|
| 0106
Page 5-15 | 0113
Page 5-16 | 0116
Page 5-16 | 0102
Page 5-16 | 0104
Page 5-17 | 0142
Page 5-17 | 0107
Page 5-17 |
|--------------------------|--------------------------|--------------------------|--------------------------|--------------------------|--------------------------|--------------------------|



Complementary Fittings

- | | | | | | | | |
|--------------------------|--------------------------|------------------------------|--------------------------|--------------------------|------------------------------|------------------------------|------------------------------|
| 0166
Page 5-20 | 0124
Page 5-21 | 0124..40
Page 5-21 | 0111
Page 5-21 | 0110
Page 5-22 | 0110..40
Page 5-22 | 0110..60
Page 5-22 | 0110..70
Page 5-22 |
|--------------------------|--------------------------|------------------------------|--------------------------|--------------------------|------------------------------|------------------------------|------------------------------|



Self-Fastening Hose Barb Connectors

- | | | |
|--------------------------|------------------------------|--------------------------|
| 0132
Page 5-25 | 0133..39
Page 5-25 | 0134
Page 5-25 |
|--------------------------|------------------------------|--------------------------|



Accessories

- | | | | | | | | | | | |
|--------------------------|--------------------------|--------------------------|--------------------------|--------------------------|------------------------------|--------------------------|--------------------------|------------------------------|------------------------------|------------------------------|
| 0122
Page 5-26 | 0165
Page 5-26 | 0126
Page 5-27 | 0125
Page 5-27 | 0220
Page 5-27 | 0220..39
Page 5-27 | 0120
Page 5-28 | 0112
Page 5-28 | 0128..39
Page 5-29 | 0151..39
Page 5-29 | 0168..39
Page 5-29 |
|--------------------------|--------------------------|--------------------------|--------------------------|--------------------------|------------------------------|--------------------------|--------------------------|------------------------------|------------------------------|------------------------------|



- | |
|--------------------------|
| 0127
Page 5-30 |
|--------------------------|



Brass Compression Fittings

These "universal" fittings provide users with numerous connection options for a wide variety of tube materials without the need for tube threading or soldering. This range guarantees excellent long-term sealing and performance.

Product Advantages

Simple to Install and Use

- Suitable for pneumatic and medium pressure hydraulic applications
- Compatible with many industrial fluids
- Large product range: 22 configurations
- Excellent sealing due to the tightening of the olive onto the tube
- Metallic sealing guarantees maximum service life
- High strength brass for increased mechanical reliability

Wide Variety of Tubing

- Connection of different types of tubing and hose: metal, polymer, steel, rubber, etc.
- Multiple tube diameters can be connected using the Parker Legris reducer assembly system
- No insert required for rigid and semi-rigid polyamide tubing below 14 mm



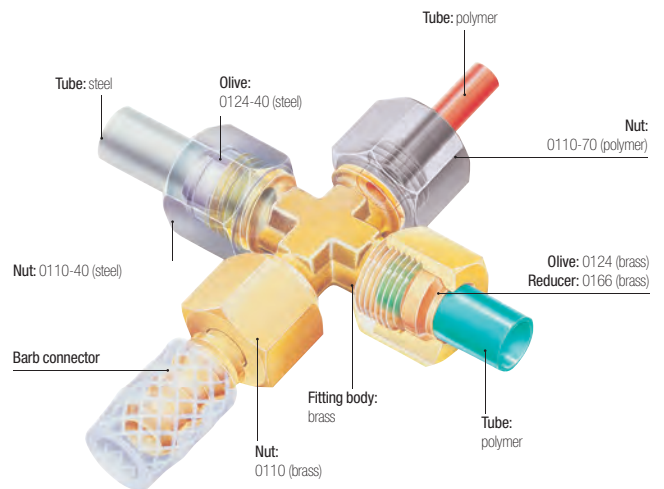
- Applications**
- Pneumatics
 - Cooling
 - Automotive Process
 - Lubrication
 - Fluid Transmission
 - Packaging
 - Industrial Machinery

Technical Characteristics

Compatible Fluids	Water, machining oil, fuel, hydraulic oil, compressed air, chemical fluids, disinfectants
Working Pressure	Vacuum to 550 bar
Working Temperature	-40°C to +250°C
Tightening Torque	See "Technical Characteristics" on opposite page

Reliable performance is dependent upon the type of fluid conveyed, component materials and tubing being used.
Guaranteed for use with a vacuum of 755 mm Hg (99% vacuum).

Component Materials



Silicone-free

Maximum Bore Diameters

The table below shows the recommended compatibility of tube size, BSPP male thread and maximum bore.

Tube O.D.	BSPP Thread	Max. Bore
4-5-6	G1/8	4
6-8-10	G1/4	7
10-12-14	G3/8	11
14-15-16-18	G1/2	14
18-20-22	G3/4	18
22-25-28	G1	24

Tube Length for Assembly

Minimum length of tube (L) between 2 fittings.







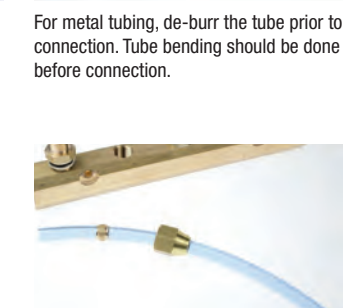
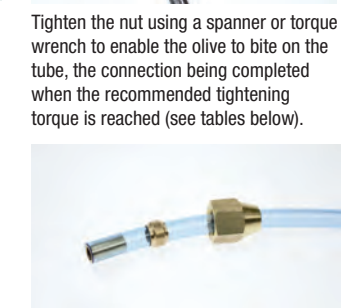
ØD	L (mm)	ØD	L (mm)	ØD	L (mm)
4	26.5	12	39	20	51
5	26	14	41	22	54
6	26	15	41	25	62
8	32	16	46.5	28	62
10	39	18	49.5		

Regulations

- CNOMO:** E07.21.115N (for robotic equipment in the automotive industry)
- DI:** 97/23/EC (PED)
- RG:** 1907/2006 (REACH)
- DI:** 2002/95/EC (RoHS)
- DI:** 94/9/EC (ATEX)

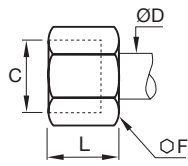
Technical Characteristics

Installing Compression Fittings

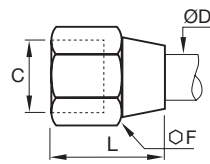
Cutting the Tube	Preparing the Connection	Connecting the Tube	Final Assembly
 <p>Cut the polymer or metal tube square.</p>	 <p>For metal tubing, de-burr the tube prior to connection. Tube bending should be done before connection.</p>	 <p>Push the tube up against the shoulder of the body of the fitting and hand tighten.</p>	 <p>Tighten the nut using a spanner or torque wrench to enable the olive to bite on the tube, the connection being completed when the recommended tightening torque is reached (see tables below).</p>
	 <p>Slide the nut onto the tube; lubricate the threads on the body and nut along with the olive to facilitate tightening (for metal tubing as well). Fit the olive onto the end of the tube.</p>		 <p>It is recommended to use an insert in order to prevent tube creeping (diameter > 14mm)</p>

Recommended Nut Tightening Torque

Tightening torque in daN.m =
 maximum tightening torque of a 0110 nut and 0124 olive with copper, brass or steel tube.



Nut 0110 and 0110..40



Nut 0110..60

Ø D (mm)	Ø F 0110	Ø F 0110..60	Max. daN.m Copper or Brass	Ø F 0110..40	Max. daN.m Steel
4	10	11	0.7	10	1.5
5	12	13	0.7	12	1.5
6	13	13	1.5	13	2.5
8	14	16	1.5	14	2.5
10	19	20	1.8	19	3
12	22	22	3	22	4.5
14	24	24	3.5	24	5.5
15	24	24	4	24	6
16	27	27	5	27	7
18	30	30	6	30	9
20	32	32	6	32	10
22	36	36	7	36	12
25	41	41	8	41	13
28	42		9		

Customised Fittings

Working directly with its customers and based on its knowledge and experience, Parker Legris can design customised brass compression fittings for specific requirements using the customer's specifications.

The range of compression fittings also offers nickel chemical surface treatment in order to improve the corrosion resistance and chemical compatibility of the fittings (the model number of the fitting is then given the suffix 99).

The above recommendations are given in good faith. However, since each application is different, it is advisable to undertake tests in actual working conditions.



Technical Characteristics

The use of Parker Legris brass compression fittings is dependant on the tube material. Tables of recommended working pressure for the different tubes are shown below.

Recommended Tube Type

Copper tube: copper which has been "cold rolled", cold drawn and in straight lengths.
Brass tube: in cold-rolled straight lengths (same working pressure as for copper tube).
"Coiled annealed" copper tube: reduces working pressure by 35%; must be avoided completely if vibration is present.

Steel tube: "thin wall" cold drawn, seamless, bright annealed and in straight lengths.
 6 mm to 16 mm O.D.: max. wall thickness 1 mm
 Above 16 mm O.D.: max. wall thickness 1.5 mm

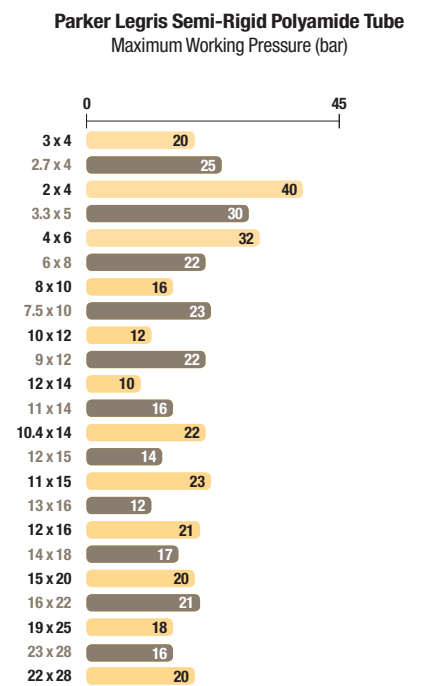
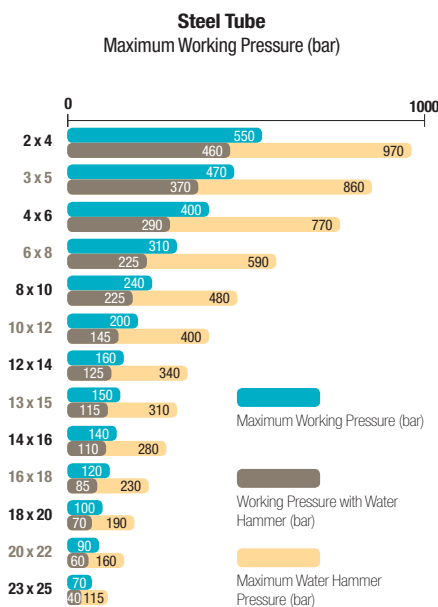
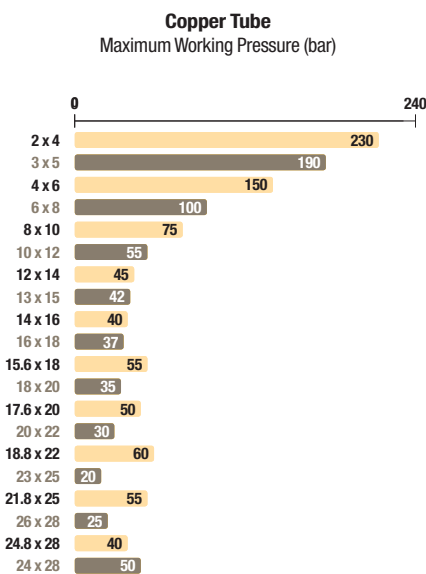
Polyamide tube: semi-rigid
 For rigid polyamide tube, multiply the figures in this table by 1.8.

Recommended Tube-Fitting Assembly Configurations

Assembled using Parker Legris brass olive and nut.

Assembled using Parker Legris steel olive and nut (nut type 0110..40).

Assembled using Parker Legris brass olive and nut.



When using a plastic nut type 0110..70, the maximum working pressure is 10 bar, for all diameters.

Working Pressure Coefficients for Semi-Rigid Polyamide Tubing

Temperature °C	-40°C / -15°C	-15°C / +30°C	+30°C / +50°C	+50°C / +70°C	+70°C / +100°C
Factor	1.8	1	0.68	0.55	0.31

Parker Legris brass compression fittings are not compatible with ammonia and its derivatives.

The above recommendations are given in good faith. However, since each application is different, it is advisable to undertake tests in actual working conditions.

Brass Compression Fittings

0105 Stud Fitting, Male BSPT Thread

ØD	C	LEGRIS	F	F1	H _{max}	H1	kg
			Brass				
4	R1/8	0105 04 10	10	10	17	7	0.012
	R1/8	0105 05 10	11	12	17.5	7.5	0.016
5	R1/4	0105 05 13	14	12	17.5	7.5	0.022
	R1/8	0105 06 10	11	13	18	7.5	0.017
6	R1/4	0105 06 13	14	13	18	7.5	0.024
	R3/8	0105 06 17	17	13	18	8.5	0.031
8	R1/8	0105 08 10	13	14	19.5	7	0.020
	R1/4	0105 08 13	14	14	19.5	7	0.025
10	R3/8	0105 08 17	17	14	20.5	8	0.032
	R1/8	0105 10 10	17	19	24	9	0.043
12	R1/4	0105 10 13	17	19	24	9	0.047
	R3/8	0105 10 17	17	19	24	9	0.048
14	R1/2	0105 10 21	22	19	25	10	0.067
	R1/4	0105 12 13	19	22	24	9	0.059
16	R3/8	0105 12 17	19	22	24	9	0.060
	R1/2	0105 12 21	22	22	25	10	0.076
18	R1/4	0105 14 13	22	24	25	8	0.068
	R3/8	0105 14 17	22	24	25	8	0.068
20	R1/2	0105 14 21	22	24	26	9	0.080
	R3/4	0105 14 27	27	24	27	10	0.107
22	R3/8	0105 15 17	22	24	25	8	0.065
	R1/2	0105 15 21	22	24	26	9	0.076
24	R1/4	0105 16 13	24	27	27	9.5	0.092
	R3/8	0105 16 17	24	27	27	9.5	0.092
26	R1/2	0105 16 21	24	27	27	9.5	0.099
	R3/4	0105 16 27	27	27	28	10.5	0.123
28	R1/2	0105 18 21	27	30	30	10.5	0.127
	R3/4	0105 18 27	27	30	30	10.5	0.138
30	R1/2	0105 20 21	30	32	32	11	0.148
	R3/4	0105 20 27	30	32	32	11	0.157
32	R1/2	0105 22 21	32	36	33	11	0.187
	R3/4	0105 22 27	32	36	33	11	0.196
34	R1	0105 22 34	36	36	33	11	0.227
	R3/4	0105 25 27	36	41	36	11	0.261
36	R1	0105 25 34	36	41	36	11	0.278
	R3/4	0105 28 27	41	42	36	11	0.274
38	R1	0105 28 34	41	42	36	11	0.283

Metric taper threads or Briggs (NPT threads) are available by special order, subject to minimum quantities.

Brass Compression Fittings

Compression Fittings

0105 Stud Fitting, Male NPT Thread

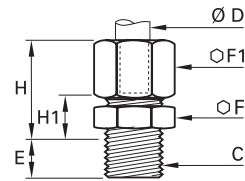
ØD	C	LEGRIS	F	F1	H _{max}	H1	kg
			Brass				
6	NPT1/8	0105 06 11	11	13	18	7.5	0.018
	NPT1/4	0105 06 14	14	13	18	7.5	0.027
8	NPT1/8	0105 08 11	13	14	21	7	0.021
	NPT1/4	0105 08 14	14	14	18.5	7	0.026
10	NPT1/4	0105 10 14	17	19	24	9	0.048
	NPT3/8	0105 10 18	17	19	24	9	0.048
12	NPT1/2	0105 10 22	22	19	25	10	0.066

Brass Compression Fittings

0101 Stud Fitting with Captive Sealing Washer, Male BSPP and Metric Thread



Brass, technical polymer



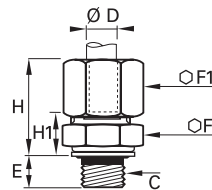
ØD	C		E	F	F1	H _{max}	H1	kg
4	M5x0.8	0101 04 19	5	10	10	16.5	8	0.011
	G1/8	0101 04 10	6.5	13	10	16.5	8	0.016
5	G1/8	0101 05 10	6.5	13	12	17.5	8.5	0.018
	G1/8	0101 06 10	6.5	13	13	18	8.5	0.020
6	G1/4	0101 06 13	8	17	13	18	9.5	0.030
	G1/8	0101 08 10	6.5	13	14	19	8.5	0.021
8	G1/4	0101 08 13	8	17	14	19.5	9	0.032
	G3/8	0101 08 17	11	22	14	20	10.5	0.044
10	G1/4	0101 10 13	8	17	19	24	11	0.049
	G3/8	0101 10 17	11	22	19	24	11.5	0.061
12	G1/4	0101 12 13	8	19	22	24	11	0.062
	G3/8	0101 12 17	11	22	22	24	11.5	0.069
14	G1/2	0101 12 21	12	27	22	24	12	0.089
	G3/8	0101 14 17	11	22	24	25	10.5	0.074
15	G1/2	0101 14 21	12	27	24	25	11	0.094
	G3/8	0101 15 17	11	22	24	25	10.5	0.071
16	G1/2	0101 15 21	12	27	24	25	11	0.093
	G3/8	0101 16 17	11	22	27	27	12	0.092
18	G1/2	0101 16 21	12	27	27	27	12.5	0.109
	G3/4	0101 18 21	12	27	30	29.5	12.5	0.128
20	G3/4	0101 18 27	13	32	30	29.5	13	0.152
	G3/4	0101 20 27	13	32	32	31	13	0.164
22	G3/4	0101 22 27	13	32	36	32	13	0.195
	G1	0101 22 34	15	41	36	31	13.5	0.259
25	G3/4	0101 25 27	13	36	41	35.5	13	0.261
	G1	0101 25 34	15	41	41	35.5	13	0.169
28	G1	0101 28 34	15	41	42	35.5	13.5	0.300

With pre-assembled captive sealing washer
Sealing washers 0602 are shown in Chapter 9.

0101..39 Stud Fitting, with Bi-Material Seal, Male BSPP



Brass, zinc-plated steel with NBR seal


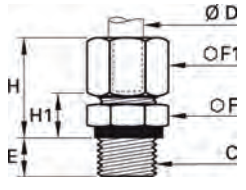



ØD	C		E	F	F1	H _{max}	H1	kg
4	G1/8	0101 04 10 39	5.5	13	10	17.5	9	0.016
5	G1/8	0101 05 10 39	5.5	13	12	18.5	9.5	0.019
	G1/8	0101 06 10 39	5.5	13	13	19	9.5	0.020
6	G1/4	0101 06 13 39	7	17	13	19	10.5	0.030
	G1/8	0101 08 10 39	5.5	13	14	20	9.5	0.022
8	G1/4	0101 08 13 39	7	17	14	20.5	10	0.032
	G3/8	0101 08 17 39	9.5	22	14	21.5	12	0.045
10	G1/4	0101 10 13 39	7	17	19	25	12	0.048
	G3/8	0101 10 17 39	9.5	22	19	25.5	13	0.062
12	G1/4	0101 12 13 39	7	19	22	25	12	0.063
	G3/8	0101 12 17 39	9.5	22	22	25	13	0.071
14	G1/2	0101 12 21 39	10.5	27	22	25	13.5	0.091
	G3/8	0101 14 17 39	9.5	22	24	26.5	12	0.075
15	G1/2	0101 14 21 39	10.5	27	24	26.5	12.5	0.095
	G3/8	0101 15 17 39	9.5	22	24	26.5	12	0.073
16	G1/2	0101 15 21 39	10.5	27	24	26.5	12.5	0.095
	G3/8	0101 16 17 39	9.5	22	27	28.5	13.5	0.092
18	G1/2	0101 16 21 39	10.5	27	27	28.5	14	0.111
	G3/4	0101 18 21 39	11.5	32	30	31	14	0.129
20	G3/4	0101 18 27 39	11.5	32	30	31	14.5	0.155
	G3/4	0101 20 27 39	11.5	32	32	32.5	14.5	0.164
22	G3/4	0101 22 27 39	11.5	32	36	32.5	14.5	0.197
	G1	0101 22 34 39	13	41	36	33	15.5	0.259
25	G1	0101 25 34 39	13	41	41	37.5	15.5	0.309
28	G1	0101 28 34 39	13	41	42	37.5	15.5	0.301


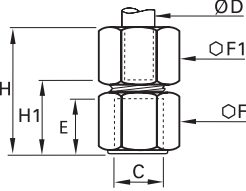

Thread with bi-material seal
Bi-material sealing washers, part number 0139, can be found in Chapter 9

Brass Compression Fittings

0101 Stud Fitting, Male Metric Thread

	Brass		ØD	C		E	F	F1	H max	H1	kg																																																																																																																																																																																																										
			<table border="1"> <tbody> <tr><td rowspan="2">4</td><td>M7x1</td><td>0101 04 55</td><td>6.5</td><td>10</td><td>10</td><td>16.5</td><td>7.5</td><td>0.012</td></tr> <tr><td>M8x1</td><td>0101 04 56</td><td>6.5</td><td>11</td><td>10</td><td>16.5</td><td>7.5</td><td>0.013</td></tr> <tr><td rowspan="2">5</td><td>M8x1</td><td>0101 05 56</td><td>6.5</td><td>11</td><td>12</td><td>17.5</td><td>8</td><td>0.016</td></tr> <tr><td>M10x1</td><td>0101 05 60</td><td>6.5</td><td>14</td><td>12</td><td>17.5</td><td>8.5</td><td>0.020</td></tr> <tr><td rowspan="2">6</td><td>M10x1</td><td>0101 06 60</td><td>6.5</td><td>14</td><td>13</td><td>18</td><td>8.5</td><td>0.021</td></tr> <tr><td>M10x1.5</td><td>0101 06 62</td><td>6.5</td><td>14</td><td>13</td><td>18</td><td>8.5</td><td>0.021</td></tr> <tr><td rowspan="3">8</td><td>M12x1</td><td>0101 08 65</td><td>8</td><td>17</td><td>14</td><td>19.5</td><td>9</td><td>0.029</td></tr> <tr><td>M12x1.25</td><td>0101 08 66</td><td>8</td><td>17</td><td>14</td><td>19.5</td><td>9</td><td>0.029</td></tr> <tr><td>M13x1.25</td><td>0101 08 68</td><td>8</td><td>17</td><td>14</td><td>19.5</td><td>9</td><td>0.030</td></tr> <tr><td rowspan="3">10</td><td>M14x1.25</td><td>0101 10 70</td><td>8</td><td>17</td><td>19</td><td>24</td><td>11</td><td>0.047</td></tr> <tr><td>M14x1.5</td><td>0101 10 71</td><td>8</td><td>17</td><td>19</td><td>24</td><td>11</td><td>0.047</td></tr> <tr><td>M16x1.25</td><td>0101 10 74</td><td>9</td><td>19</td><td>19</td><td>24</td><td>11</td><td>0.051</td></tr> <tr><td rowspan="3">12</td><td>M16x1.5</td><td>0101 10 75</td><td>9</td><td>19</td><td>19</td><td>24</td><td>11</td><td>0.051</td></tr> <tr><td>M18x1.5</td><td>0101 10 78</td><td>9</td><td>22</td><td>19</td><td>24</td><td>11.5</td><td>0.060</td></tr> <tr><td>M16x1.25</td><td>0101 12 74</td><td>9</td><td>19</td><td>22</td><td>24</td><td>11</td><td>0.061</td></tr> <tr><td rowspan="3">14</td><td>M16x1.5</td><td>0101 12 75</td><td>9</td><td>19</td><td>22</td><td>24</td><td>11</td><td>0.061</td></tr> <tr><td>M18x1.5</td><td>0101 12 78</td><td>9</td><td>22</td><td>22</td><td>24</td><td>11.5</td><td>0.070</td></tr> <tr><td>M18x1.5</td><td>0101 14 78</td><td>9</td><td>22</td><td>24</td><td>25</td><td>10.5</td><td>0.077</td></tr> <tr><td rowspan="2">15</td><td>M20x1.5</td><td>0101 14 80</td><td>10</td><td>24</td><td>24</td><td>25</td><td>11</td><td>0.084</td></tr> <tr><td>M18x1.5</td><td>0101 15 78</td><td>9</td><td>22</td><td>24</td><td>25</td><td>10.5</td><td>0.071</td></tr> <tr><td rowspan="2">16</td><td>M20x1.5</td><td>0101 16 80</td><td>10</td><td>24</td><td>27</td><td>27</td><td>12.5</td><td>0.102</td></tr> <tr><td>M22x1.5</td><td>0101 16 82</td><td>10</td><td>27</td><td>27</td><td>27</td><td>12.5</td><td>0.111</td></tr> <tr><td rowspan="2">18</td><td>M22x1.5</td><td>0101 18 82</td><td>10</td><td>27</td><td>30</td><td>29.5</td><td>12.5</td><td>0.129</td></tr> <tr><td>M24x1.5</td><td>0101 18 83</td><td>11</td><td>30</td><td>30</td><td>29.5</td><td>13</td><td>0.142</td></tr> </tbody> </table>												4	M7x1	0101 04 55	6.5	10	10	16.5	7.5	0.012	M8x1	0101 04 56	6.5	11	10	16.5	7.5	0.013	5	M8x1	0101 05 56	6.5	11	12	17.5	8	0.016	M10x1	0101 05 60	6.5	14	12	17.5	8.5	0.020	6	M10x1	0101 06 60	6.5	14	13	18	8.5	0.021	M10x1.5	0101 06 62	6.5	14	13	18	8.5	0.021	8	M12x1	0101 08 65	8	17	14	19.5	9	0.029	M12x1.25	0101 08 66	8	17	14	19.5	9	0.029	M13x1.25	0101 08 68	8	17	14	19.5	9	0.030	10	M14x1.25	0101 10 70	8	17	19	24	11	0.047	M14x1.5	0101 10 71	8	17	19	24	11	0.047	M16x1.25	0101 10 74	9	19	19	24	11	0.051	12	M16x1.5	0101 10 75	9	19	19	24	11	0.051	M18x1.5	0101 10 78	9	22	19	24	11.5	0.060	M16x1.25	0101 12 74	9	19	22	24	11	0.061	14	M16x1.5	0101 12 75	9	19	22	24	11	0.061	M18x1.5	0101 12 78	9	22	22	24	11.5	0.070	M18x1.5	0101 14 78	9	22	24	25	10.5	0.077	15	M20x1.5	0101 14 80	10	24	24	25	11	0.084	M18x1.5	0101 15 78	9	22	24	25	10.5	0.071	16	M20x1.5	0101 16 80	10	24	27	27	12.5	0.102	M22x1.5	0101 16 82	10	27	27	27	12.5	0.111	18	M22x1.5	0101 18 82	10	27	30	29.5	12.5	0.129	M24x1.5	0101 18 83	11	30	30
4	M7x1	0101 04 55	6.5	10	10	16.5	7.5	0.012																																																																																																																																																																																																													
	M8x1	0101 04 56	6.5	11	10	16.5	7.5	0.013																																																																																																																																																																																																													
5	M8x1	0101 05 56	6.5	11	12	17.5	8	0.016																																																																																																																																																																																																													
	M10x1	0101 05 60	6.5	14	12	17.5	8.5	0.020																																																																																																																																																																																																													
6	M10x1	0101 06 60	6.5	14	13	18	8.5	0.021																																																																																																																																																																																																													
	M10x1.5	0101 06 62	6.5	14	13	18	8.5	0.021																																																																																																																																																																																																													
8	M12x1	0101 08 65	8	17	14	19.5	9	0.029																																																																																																																																																																																																													
	M12x1.25	0101 08 66	8	17	14	19.5	9	0.029																																																																																																																																																																																																													
	M13x1.25	0101 08 68	8	17	14	19.5	9	0.030																																																																																																																																																																																																													
10	M14x1.25	0101 10 70	8	17	19	24	11	0.047																																																																																																																																																																																																													
	M14x1.5	0101 10 71	8	17	19	24	11	0.047																																																																																																																																																																																																													
	M16x1.25	0101 10 74	9	19	19	24	11	0.051																																																																																																																																																																																																													
12	M16x1.5	0101 10 75	9	19	19	24	11	0.051																																																																																																																																																																																																													
	M18x1.5	0101 10 78	9	22	19	24	11.5	0.060																																																																																																																																																																																																													
	M16x1.25	0101 12 74	9	19	22	24	11	0.061																																																																																																																																																																																																													
14	M16x1.5	0101 12 75	9	19	22	24	11	0.061																																																																																																																																																																																																													
	M18x1.5	0101 12 78	9	22	22	24	11.5	0.070																																																																																																																																																																																																													
	M18x1.5	0101 14 78	9	22	24	25	10.5	0.077																																																																																																																																																																																																													
15	M20x1.5	0101 14 80	10	24	24	25	11	0.084																																																																																																																																																																																																													
	M18x1.5	0101 15 78	9	22	24	25	10.5	0.071																																																																																																																																																																																																													
16	M20x1.5	0101 16 80	10	24	27	27	12.5	0.102																																																																																																																																																																																																													
	M22x1.5	0101 16 82	10	27	27	27	12.5	0.111																																																																																																																																																																																																													
18	M22x1.5	0101 18 82	10	27	30	29.5	12.5	0.129																																																																																																																																																																																																													
	M24x1.5	0101 18 83	11	30	30	29.5	13	0.142																																																																																																																																																																																																													

0114 Stud Fitting, Female BSPP Thread

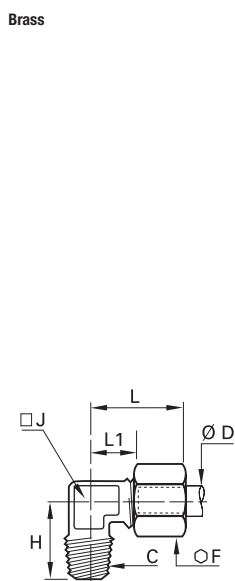
	Brass		ØD	C		E	F	F1	H max	H1	kg																																																																																																																																																																																																																																																																													
			<table border="1"> <tbody> <tr><td rowspan="2">4</td><td>G1/8</td><td>0114 04 10</td><td>9.5</td><td>14</td><td>10</td><td>26</td><td>16.5</td><td>0.020</td></tr> <tr><td>G1/4</td><td>0114 04 13</td><td>13.5</td><td>17</td><td>10</td><td>30</td><td>20.5</td><td>0.030</td></tr> <tr><td rowspan="2">5</td><td>G1/8</td><td>0114 05 10</td><td>9.5</td><td>14</td><td>12</td><td>28</td><td>17</td><td>0.023</td></tr> <tr><td>G1/4</td><td>0114 05 13</td><td>13.5</td><td>17</td><td>12</td><td>31</td><td>21</td><td>0.033</td></tr> <tr><td rowspan="2">6</td><td>G1/8</td><td>0114 06 10</td><td>9.5</td><td>14</td><td>13</td><td>28</td><td>17</td><td>0.025</td></tr> <tr><td>G1/4</td><td>0114 06 13</td><td>13.5</td><td>17</td><td>13</td><td>32</td><td>21</td><td>0.034</td></tr> <tr><td rowspan="3">8</td><td>G3/8</td><td>0114 06 17</td><td>14</td><td>22</td><td>13</td><td>32</td><td>21.5</td><td>0.051</td></tr> <tr><td>G1/8</td><td>0114 08 10</td><td>9.5</td><td>14</td><td>14</td><td>29</td><td>16.5</td><td>0.026</td></tr> <tr><td>G1/4</td><td>0114 08 13</td><td>13.5</td><td>17</td><td>14</td><td>33</td><td>20.5</td><td>0.036</td></tr> <tr><td rowspan="3">10</td><td>G3/8</td><td>0114 08 17</td><td>14</td><td>22</td><td>14</td><td>34</td><td>21</td><td>0.052</td></tr> <tr><td>G1/4</td><td>0114 10 13</td><td>13.5</td><td>17</td><td>19</td><td>37</td><td>21.5</td><td>0.052</td></tr> <tr><td>G3/8</td><td>0114 10 17</td><td>14</td><td>22</td><td>19</td><td>37</td><td>22</td><td>0.068</td></tr> <tr><td rowspan="3">12</td><td>G1/2</td><td>0114 10 21</td><td>18.5</td><td>27</td><td>19</td><td>42</td><td>26.5</td><td>0.099</td></tr> <tr><td>G1/4</td><td>0114 12 13</td><td>13.5</td><td>19</td><td>22</td><td>36</td><td>20.5</td><td>0.069</td></tr> <tr><td>G3/8</td><td>0114 12 17</td><td>14</td><td>22</td><td>22</td><td>37</td><td>22</td><td>0.078</td></tr> <tr><td rowspan="3">14</td><td>G1/2</td><td>0114 12 21</td><td>18.5</td><td>27</td><td>22</td><td>42</td><td>26.5</td><td>0.109</td></tr> <tr><td>G1/4</td><td>0114 14 13</td><td>13.5</td><td>22</td><td>24</td><td>36</td><td>18.5</td><td>0.085</td></tr> <tr><td>G3/8</td><td>0114 14 17</td><td>14</td><td>22</td><td>24</td><td>38</td><td>21</td><td>0.048</td></tr> <tr><td rowspan="3">15</td><td>G1/2</td><td>0114 14 21</td><td>18.5</td><td>27</td><td>24</td><td>43</td><td>25.5</td><td>0.113</td></tr> <tr><td>G3/8</td><td>0114 15 17</td><td>14</td><td>22</td><td>24</td><td>38</td><td>21</td><td>0.078</td></tr> <tr><td>G1/2</td><td>0114 15 21</td><td>18.5</td><td>27</td><td>24</td><td>43</td><td>25.5</td><td>0.109</td></tr> <tr><td rowspan="3">16</td><td>G1/4</td><td>0114 16 13</td><td>13.5</td><td>24</td><td>27</td><td>36</td><td>18</td><td>0.107</td></tr> <tr><td>G3/8</td><td>0114 16 17</td><td>14</td><td>24</td><td>27</td><td>38</td><td>20.5</td><td>0.106</td></tr> <tr><td>G1/2</td><td>0114 16 21</td><td>18.5</td><td>27</td><td>27</td><td>44</td><td>26</td><td>0.127</td></tr> <tr><td rowspan="3">18</td><td>G3/8</td><td>0114 18 17</td><td>14</td><td>27</td><td>30</td><td>39</td><td>19.5</td><td>0.140</td></tr> <tr><td>G1/2</td><td>0114 18 21</td><td>18.5</td><td>27</td><td>30</td><td>45</td><td>26</td><td>0.144</td></tr> <tr><td>G3/4</td><td>0114 18 27</td><td>19.5</td><td>32</td><td>30</td><td>46</td><td>27</td><td>0.165</td></tr> <tr><td rowspan="3">20</td><td>G3/8</td><td>0114 20 17</td><td>14</td><td>30</td><td>32</td><td>38</td><td>18</td><td>0.161</td></tr> <tr><td>G1/2</td><td>0114 20 21</td><td>18.5</td><td>30</td><td>32</td><td>44.5</td><td>24</td><td>0.173</td></tr> <tr><td>G3/4</td><td>0114 20 27</td><td>19.5</td><td>32</td><td>32</td><td>47</td><td>26.5</td><td>0.170</td></tr> <tr><td>22</td><td>G3/4</td><td>0114 22 27</td><td>19.5</td><td>32</td><td>36</td><td>48</td><td>26.5</td><td>0.204</td></tr> <tr><td>25</td><td>G3/4</td><td>0114 25 27</td><td>19.5</td><td>36</td><td>41</td><td>50.5</td><td>26</td><td>0.297</td></tr> </tbody> </table>												4	G1/8	0114 04 10	9.5	14	10	26	16.5	0.020	G1/4	0114 04 13	13.5	17	10	30	20.5	0.030	5	G1/8	0114 05 10	9.5	14	12	28	17	0.023	G1/4	0114 05 13	13.5	17	12	31	21	0.033	6	G1/8	0114 06 10	9.5	14	13	28	17	0.025	G1/4	0114 06 13	13.5	17	13	32	21	0.034	8	G3/8	0114 06 17	14	22	13	32	21.5	0.051	G1/8	0114 08 10	9.5	14	14	29	16.5	0.026	G1/4	0114 08 13	13.5	17	14	33	20.5	0.036	10	G3/8	0114 08 17	14	22	14	34	21	0.052	G1/4	0114 10 13	13.5	17	19	37	21.5	0.052	G3/8	0114 10 17	14	22	19	37	22	0.068	12	G1/2	0114 10 21	18.5	27	19	42	26.5	0.099	G1/4	0114 12 13	13.5	19	22	36	20.5	0.069	G3/8	0114 12 17	14	22	22	37	22	0.078	14	G1/2	0114 12 21	18.5	27	22	42	26.5	0.109	G1/4	0114 14 13	13.5	22	24	36	18.5	0.085	G3/8	0114 14 17	14	22	24	38	21	0.048	15	G1/2	0114 14 21	18.5	27	24	43	25.5	0.113	G3/8	0114 15 17	14	22	24	38	21	0.078	G1/2	0114 15 21	18.5	27	24	43	25.5	0.109	16	G1/4	0114 16 13	13.5	24	27	36	18	0.107	G3/8	0114 16 17	14	24	27	38	20.5	0.106	G1/2	0114 16 21	18.5	27	27	44	26	0.127	18	G3/8	0114 18 17	14	27	30	39	19.5	0.140	G1/2	0114 18 21	18.5	27	30	45	26	0.144	G3/4	0114 18 27	19.5	32	30	46	27	0.165	20	G3/8	0114 20 17	14	30	32	38	18	0.161	G1/2	0114 20 21	18.5	30	32	44.5	24	0.173	G3/4	0114 20 27	19.5	32	32	47	26.5	0.170	22	G3/4	0114 22 27	19.5	32	36	48	26.5	0.204	25	G3/4	0114 25 27	19.5	36	41
4	G1/8	0114 04 10	9.5	14	10	26	16.5	0.020																																																																																																																																																																																																																																																																																
	G1/4	0114 04 13	13.5	17	10	30	20.5	0.030																																																																																																																																																																																																																																																																																
5	G1/8	0114 05 10	9.5	14	12	28	17	0.023																																																																																																																																																																																																																																																																																
	G1/4	0114 05 13	13.5	17	12	31	21	0.033																																																																																																																																																																																																																																																																																
6	G1/8	0114 06 10	9.5	14	13	28	17	0.025																																																																																																																																																																																																																																																																																
	G1/4	0114 06 13	13.5	17	13	32	21	0.034																																																																																																																																																																																																																																																																																
8	G3/8	0114 06 17	14	22	13	32	21.5	0.051																																																																																																																																																																																																																																																																																
	G1/8	0114 08 10	9.5	14	14	29	16.5	0.026																																																																																																																																																																																																																																																																																
	G1/4	0114 08 13	13.5	17	14	33	20.5	0.036																																																																																																																																																																																																																																																																																
10	G3/8	0114 08 17	14	22	14	34	21	0.052																																																																																																																																																																																																																																																																																
	G1/4	0114 10 13	13.5	17	19	37	21.5	0.052																																																																																																																																																																																																																																																																																
	G3/8	0114 10 17	14	22	19	37	22	0.068																																																																																																																																																																																																																																																																																
12	G1/2	0114 10 21	18.5	27	19	42	26.5	0.099																																																																																																																																																																																																																																																																																
	G1/4	0114 12 13	13.5	19	22	36	20.5	0.069																																																																																																																																																																																																																																																																																
	G3/8	0114 12 17	14	22	22	37	22	0.078																																																																																																																																																																																																																																																																																
14	G1/2	0114 12 21	18.5	27	22	42	26.5	0.109																																																																																																																																																																																																																																																																																
	G1/4	0114 14 13	13.5	22	24	36	18.5	0.085																																																																																																																																																																																																																																																																																
	G3/8	0114 14 17	14	22	24	38	21	0.048																																																																																																																																																																																																																																																																																
15	G1/2	0114 14 21	18.5	27	24	43	25.5	0.113																																																																																																																																																																																																																																																																																
	G3/8	0114 15 17	14	22	24	38	21	0.078																																																																																																																																																																																																																																																																																
	G1/2	0114 15 21	18.5	27	24	43	25.5	0.109																																																																																																																																																																																																																																																																																
16	G1/4	0114 16 13	13.5	24	27	36	18	0.107																																																																																																																																																																																																																																																																																
	G3/8	0114 16 17	14	24	27	38	20.5	0.106																																																																																																																																																																																																																																																																																
	G1/2	0114 16 21	18.5	27	27	44	26	0.127																																																																																																																																																																																																																																																																																
18	G3/8	0114 18 17	14	27	30	39	19.5	0.140																																																																																																																																																																																																																																																																																
	G1/2	0114 18 21	18.5	27	30	45	26	0.144																																																																																																																																																																																																																																																																																
	G3/4	0114 18 27	19.5	32	30	46	27	0.165																																																																																																																																																																																																																																																																																
20	G3/8	0114 20 17	14	30	32	38	18	0.161																																																																																																																																																																																																																																																																																
	G1/2	0114 20 21	18.5	30	32	44.5	24	0.173																																																																																																																																																																																																																																																																																
	G3/4	0114 20 27	19.5	32	32	47	26.5	0.170																																																																																																																																																																																																																																																																																
22	G3/4	0114 22 27	19.5	32	36	48	26.5	0.204																																																																																																																																																																																																																																																																																
25	G3/4	0114 25 27	19.5	36	41	50.5	26	0.297																																																																																																																																																																																																																																																																																

Brass Compression Fittings

Compression Fittings

Brass Compression Fittings

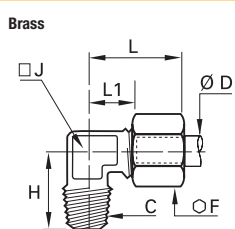
0109 Stud Elbow, Male BSPT Thread



ØD	C		F	H	J	L _{max}	L1	kg
4	R1/8	0109 04 10	10	17	8	19	9.5	0.016
	R1/4	0109 04 13	10	20	10	19	11	0.026
5	R1/8	0109 05 10	12	17.5	8	21	11	0.019
	R1/4	0109 05 13	12	21.5	10	22	12	0.028
6	R1/8	0109 06 10	13	18	8	22	11	0.021
	R1/4	0109 06 13	13	21.5	10	22	12	0.031
8	R1/8	0109 08 10	14	18.5	10	28	15	0.028
	R3/8	0109 08 13	14	22	10	28	15	0.033
10	R1/4	0109 10 13	14	24	12	28	15	0.044
	R3/8	0109 10 17	19	25	12	30	14.5	0.052
12	R1/2	0109 10 21	19	25.5	12	30	14.5	0.060
	R3/8	0109 12 17	19	32	19	36	21	0.109
14	R1/4	0109 12 13	22	26	15	30	15	0.074
	R3/8	0109 12 17	22	27	15	30	15	0.077
15	R1/2	0109 12 21	22	32	19	36	21	0.116
	R3/8	0109 14 17	24	30	19	35	18	0.105
16	R1/2	0109 14 21	24	32	19	35	18	0.112
	R3/8	0109 15 17	24	30	19	35	18	0.099
18	R1/2	0109 15 21	24	32	19	35	18	0.106
	R3/8	0109 16 17	27	30	19	39	21	0.120
20	R1/2	0109 16 21	27	33.5	19	39	21	0.130
	R3/4	0109 16 27	27	36.5	23	41	23	0.189
22	R1/2	0109 18 21	30	35.5	23	41	21.5	0.182
	R3/4	0109 18 27	30	36.5	23	41	21.5	0.199
25	R1/2	0109 20 21	32	36.5	23	42	21.5	0.181
	R3/4	0109 20 27	32	38	23	42	21.5	0.200
28	R3/4	0109 22 27	36	40	27	50	30	0.288
	R1	0109 22 34	36	44	27	50	30	0.342
28	R3/4	0109 25 27	41	43	27	54	30	0.325
	R1	0109 25 34	41	44	27	54	30	0.367
28	R3/4	0109 28 27	42	46	32	54	30	0.402
	R1	0109 28 34	42	48	32	54	30	0.384

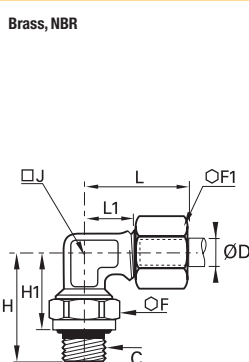
Metric taper threads or Briggs (NPT threads) are available by special order, subject to minimum quantities.

0109 Stud Elbow, Male NPT Thread



ØD	C		F	H	J	L _{max}	L1	kg
6	NPT1/8	0109 06 11	13	18	8	22	11	0.021
	NPT1/4	0109 06 14	13	21.5	10	22	12	0.030
8	NPT1/8	0109 08 11	14	18.5	10	28	15	0.028
	NPT1/4	0109 08 14	14	22	10	28	15	0.033
10	NPT1/4	0109 10 14	19	25	12	30	14.5	0.053

0199 Stud Orientable Elbow, Male BSPP Thread

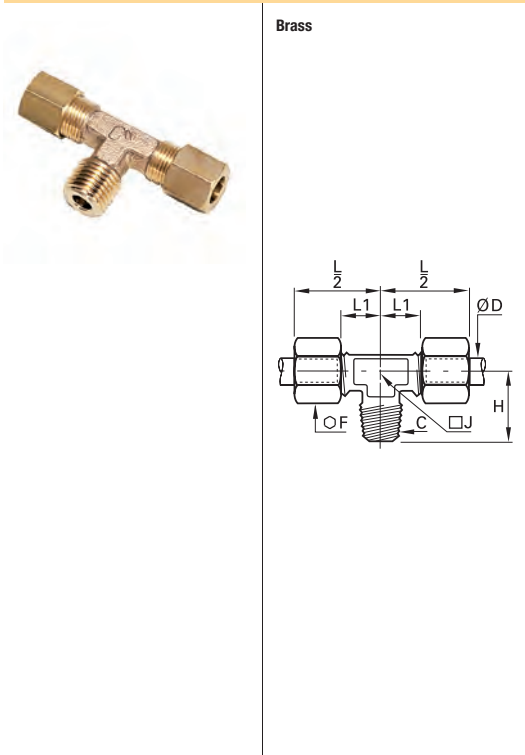


ØD	C		F	F1	H	H1	H1 _{max}	J	L _{max}	L1	kg
4	G1/8	0199 04 10	14	10	23	16	17	8	19	9.5	0.023
	G1/4	0199 04 13	19	10	30.5	22	23.5	10	19	11	0.043
6	G1/8	0199 06 10	14	13	23	16	17	8	22	11	0.027
	G1/4	0199 06 13	19	13	30.5	22	23.5	10	22	12	0.047
8	G1/8	0199 08 10	14	14	24	17	18	10	28	15	0.033
	G1/4	0199 08 13	19	14	30.5	22	23.5	10	28	15	0.051
10	G3/8	0199 08 17	22	14	33.5	24	25.5	12	28	15	0.065
	G1/4	0199 10 13	19	19	31	22.5	24	12	30	14.5	0.068
14	G3/8	0199 10 17	22	19	33.5	24	25.5	12	30	14.5	0.079
	G1/2	0199 10 21	27	19	40	29.5	31	19	37	22	0.138
18	G3/8	0199 14 17	22	24	35.5	26	27.5	19	35	18	0.119
	G1/2	0199 14 21	27	24	40	29.5	31	19	35	18	0.141
22	G1/2	0199 18 21	27	30	40	29	30.5	23	41	21.5	0.187
	G3/4	0199 18 27	32	30	43.5	32	33.5	23	41	21.5	0.222
28	G1	0199 22 27	32	36	45.5	34	36	32	51	31	0.382
	G1	0199 22 34	41	36	54	40.5	43	32	51	31	0.408
28	G1	0199 28 34	41	42	54	40.5	43	32	54	30	0.420

The body will orientate for positioning purposes

Brass Compression Fittings

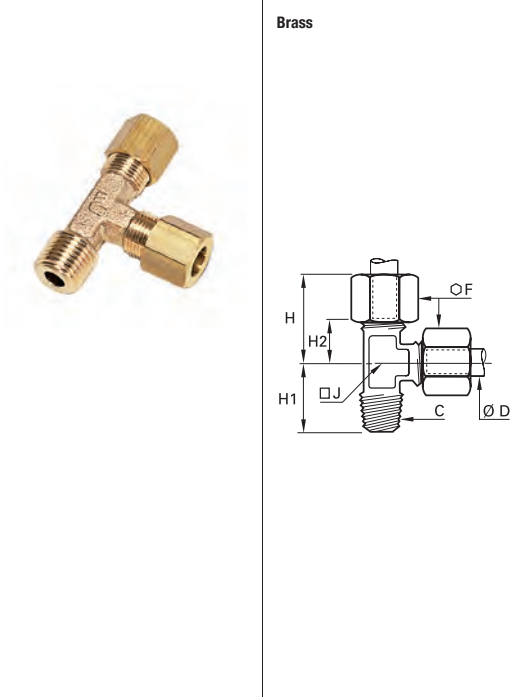
0108 Stud Branch Tee, Male BSPT Thread



ØD	C		F	H	J	L1	L/2	kg
4	R1/8	0108 04 10	10	17	8	9.5	19	0.025
5	R1/8	0108 05 10	12	17.5	8	11	21	0.017
6	R1/8	0108 06 10	13	18	8	11	22	0.032
	R1/4	0108 06 13	13	21.5	10	16	27	0.047
8	R1/8	0108 08 10	14	18.5	10	15	28	0.045
	R1/4	0108 08 13	14	22	10	15	28	0.050
10	R3/8	0108 08 17	14	24	12	15	28	0.061
	R1/4	0108 10 13	19	25	12	14.5	30	0.084
12	R3/8	0108 10 17	19	25.5	12	14.5	30	0.090
	R1/4	0108 12 13	22	26	15	15	30	0.116
14	R3/8	0108 12 17	22	27	15	15	30	0.117
	R3/8	0108 14 17	24	30	19	18	35	0.153
15	R1/2	0108 14 21	24	32	19	18	35	0.168
	R3/8	0108 15 17	24	30	19	18	35	0.145
16	R1/2	0108 15 21	24	32	19	18	35	0.155
	R3/8	0108 16 17	27	30	19	21	39	0.190
18	R1/2	0108 16 21	27	33.5	19	21	39	0.203
	R1/2	0108 18 21	30	35.5	23	21.5	41	0.265
20	R3/4	0108 18 27	30	36.5	23	21.5	41	0.292
	R3/4	0108 20 27	32	38	23	21.5	42	0.298
22	R3/4	0108 22 27	36	40	27	29	50	0.435
	R1	0108 22 34	36	44	27	29	50	0.466

Metric taper threads or Briggs (NPT threads) are available by special order, subject to minimum quantities.

0103 Stud Run Tee, Male BSPT Thread



ØD	C		F	H max	H1	H2	J	kg
4	R1/8	0103 04 10	10	19	17	9.5	8	0.025
5	R1/8	0103 05 10	12	21	17.5	11	8	0.030
6	R1/8	0103 06 10	13	22	18	11	8	0.033
	R1/4	0103 06 13	13	27	21.5	16	10	0.048
8	R1/8	0103 08 10	14	28	18.5	15	10	0.045
	R1/4	0103 08 13	14	28	22	15	10	0.050
10	R3/8	0103 08 17	14	28	24	15	12	0.061
	R1/4	0103 10 13	19	30	25	14.5	12	0.084
12	R3/8	0103 10 17	19	30	25.5	14.5	12	0.092
	R1/4	0103 12 13	22	30	26	15	15	0.114
14	R3/8	0103 12 17	22	30	27	15	15	0.120
	R3/8	0103 14 17	24	35	30	18	19	0.161
15	R1/2	0103 14 21	24	35	32	18	19	0.169
	R3/8	0103 15 17	24	35	30	18	19	0.148
16	R1/2	0103 15 21	24	35	32	18	19	0.158
	R3/8	0103 16 17	27	39	30	21	19	0.192
18	R1/2	0103 16 21	27	39	33.5	21	19	0.199
	R1/2	0103 18 21	30	41	35.5	21.5	23	0.269
20	R3/4	0103 18 27	30	41	36.5	21.5	23	0.282
	R3/4	0103 20 27	32	42	38	21.5	23	0.298
22	R3/4	0103 22 27	36	50	40	29	27	0.435


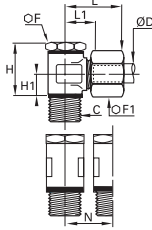

Metric taper threads or Briggs (NPT threads) are available by special order, subject to minimum quantities.

Brass Compression Fittings

Compression Fittings


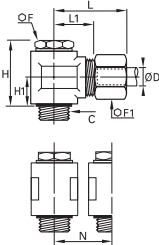

Brass Compression Fittings

0118 Single Banjo, with Captive Sealing Washer, Male BSPP Thread

	Brass, technical polymer 	ØD	C		F	F1	H	H1	L_{max}	L1	N	kg
		4	G1/8	0118 04 10	14	10	24	9.5	24	14.5	17.5	0.038
		5	G1/8	0118 05 10	14	12	24	9.5	25	14.5	17.5	0.041
			G1/4	0118 05 13	17	12	25	10	26	16	21	0.058
		6	G1/8	0118 06 10	14	13	24	9.5	25	14.5	17.5	0.041
			G1/4	0118 06 13	17	13	25	10	26	16	21	0.056
		8	G1/8	0118 08 10	14	14	24	9.5	28	15.5	17.5	0.054
			G1/4	0118 08 13	17	14	25	10	28	15.5	21	0.057
			G3/8	0118 08 17	22	14	32	13	30	18	26.5	0.111
		10	G1/4	0118 10 13	17	19	31	13	34	19	23	0.120
			G3/8	0118 10 17	22	19	32	13	34	19	26.5	0.129
		12	G1/4	0118 12 13	17	22	34	14.5	34	19	23	0.126
			G3/8	0118 12 17	22	22	35	14.5	34	19	26.5	0.133
		14	G1/4	0118 14 13	17	24	37	16	37	20.5	28	0.154
			G3/8	0118 14 17	22	24	38	16	37	20.5	28	0.195
			G1/2	0118 14 21	27	24	40	16	38	20.5	32.5	0.208
		15	G3/8	0118 15 17	22	24	38	16	37	20.5	28	0.190
			G1/2	0118 15 21	27	24	40	16	38	20.5	32.5	0.198
		16	G1/2	0118 16 21	27	27	42	16	38	21	32.5	0.221
		18	G1/2	0118 18 21	27	30	46	19.5	43	24.5	36	0.366
		20	G3/4	0118 20 27	32	32	49	20	44	24.5	39	0.403
		22	G3/4	0118 22 27	32	36	53	22	45	24.5	39	0.459

With pre-assembled captive sealing washer
Sealing washers 0602 can be found in Chapter 9.

0118..39 Single Banjo with Bi-Material Seal, Male BSPP Thread

	Brass, zinc-plated steel with NBR seal 	ØD	C		F	F1	H	H1	L_{max}	L1	N	kg
		4	G1/8	0118 04 10 39	14	10	23	9.5	24	14.5	17.5	0.038
		5	G1/8	0118 05 10 39	14	12	23	9.5	25	14.5	17.5	0.041
			G1/4	0118 05 13 39	17	12	24	10	26	16	21	0.064
		6	G1/8	0118 06 10 39	14	13	23	9.5	25	14.5	17.5	0.042
			G1/4	0118 06 13 39	17	13	24	10	26	16	21	0.057
		8	G1/8	0118 08 10 39	14	14	23	9.5	28	15.5	17.5	0.055
			G1/4	0118 08 13 39	17	14	24	10	28	15.5	21	0.058
			G3/8	0118 08 17 39	22	14	31.5	13.5	30	18	26.5	0.113
		10	G1/4	0118 10 13 39	17	19	30	13	34	19	23	0.118
			G3/8	0118 10 17 39	22	19	31.5	13.5	34	19	26.5	0.128
		12	G1/4	0118 12 13 39	17	22	33	14.5	34	19	23	0.128
			G3/8	0118 12 17 39	22	22	34.5	15	34	19	26.5	0.140
		14	G1/4	0118 14 13 39	17	24	36	16	37	20.5	28	0.189
			G3/8	0118 14 17 39	22	24	37.5	16.5	37	20.5	28	0.198
			G1/2	0118 14 21 39	27	24	39	16.5	38	20.5	32.5	0.205
		15	G3/8	0118 15 17 39	22	24	37.5	16.5	37	20.5	28	0.389
			G1/2	0118 15 21 39	27	24	40	16.5	38	20.5	32.5	0.202
		16	G1/2	0118 16 21 39	27	27	40	16.5	38	21	32.5	0.225
		18	G1/2	0118 18 21 39	27	30	47	20	43	24.5	36	0.369
		20	G3/4	0118 20 27 39	32	32	50	20.5	44	24.5	39	0.394
		22	G3/4	0118 22 27 39	32	36	54	22.5	45	24.5	39	0.462

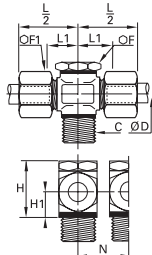
With bi-material sealing washer
Bi-material sealing washers, part number 0139, can be found in Chapter 9.

Brass Compression Fittings

0119 Double Banjo with Captive Sealing Washer, Male BSPP Thread



Brass, technical polymer



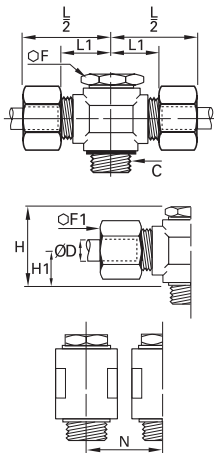
ØD	C		F	F1	H	H1	L1	L/2	N	kg
4	G1/8	0119 04 10	14	10	24	9.5	14.5	24	17.5	0.049
6	G1/8	0119 06 10	14	13	24	9.5	14.5	25	17.5	0.056
	G1/4	0119 06 13	17	13	25	10	16	26.5	21	0.038
8	G1/8	0119 08 10	14	14	24	9.5	15.5	28	17.5	0.069
	G3/8	0119 08 17	17	14	25	10	15.5	28	21	0.074
10	G1/4	0119 10 13	17	19	31	13	19	34	23	0.156
	G3/8	0119 10 17	22	19	32	13	19	34	26.5	0.165
12	G1/4	0119 12 13	17	22	34	14.5	19	34	23	0.180
	G3/8	0119 12 17	22	22	35	14.5	19	34	26.5	0.182
14	G1/4	0119 14 13	17	24	37	16	20.5	37.5	28	0.246
	G3/8	0119 14 17	22	24	38	16	20.5	37.5	28	0.247
	G1/2	0119 14 21	27	24	40	16	20.5	38	32.5	0.219

Thread with pre-assembled washer
Sealing washers 0602 can be found in Chapter 9.

0119..39 Double Banjo with Bi-Material Seal, Male BSPP Thread



Brass, zinc-plated steel with NBR seal



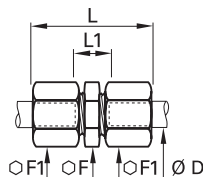
ØD	C		F	F1	H	H1	L1	L/2	N	kg
4	G1/8	0119 04 10 39	14	10	23	9.5	14.5	24	17.5	0.050
5	G1/8	0119 05 10 39	14	12	23	9.5	14.5	25	17.5	0.049
	G1/4	0119 05 13 39	17	12	24	10	126	26	21	0.072
6	G1/8	0119 06 10 39	14	13	23	9.5	14.5	25	17.5	0.056
	G1/4	0119 06 13 39	17	13	24	10	16	26	21	0.071
8	G1/8	0119 08 10 39	14	14	23	9.5	15.5	28	17.5	0.072
	G1/4	0119 08 13 39	17	14	24	10	15.5	28	21	0.080
10	G3/8	0119 08 17 39	22	14	31.5	13.5	18	30	26.5	0.118
	G1/4	0119 10 13 39	17	19	30	13	19	34	23	0.156
12	G3/8	0119 10 17 39	22	19	31.5	13.5	19	34	26.5	0.167
	G1/4	0119 12 13 39	17	22	33	14.5	19	34	23	0.180
14	G3/8	0119 12 17 39	22	22	34.5	15	19	34	26.5	0.183
	G1/4	0119 14 13 39	17	24	36	16	20.5	37	28	0.248
15	G3/8	0119 14 17 39	22	24	37.5	16.5	20.5	37	28	0.247
	G1/2	0119 14 21 39	27	24	39	16.5	20.5	38	32.5	0.262
18	G3/8	0119 15 17 39	22	24	37.5	16.5	20.5	37	28	0.246
	G1/2	0119 15 21 39	27	24	40	16.5	20.5	38	32.5	0.251
20	G1/2	0119 18 21 39	27	30	47	20	24.5	43	36	0.469
22	G3/4	0119 20 27 39	32	32	50	20.5	24.5	44	39	0.638
22	G3/4	0119 22 27 39	32	36	54	22.5	24.5	45	39	0.610

Thread with pre-assembled washer
Bi-material sealing washers, part number 0139, can be found in Chapter 9.

0106 Equal Tube-to-Tube Connector



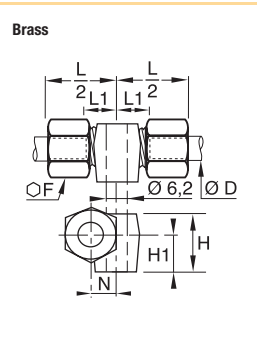
Brass



ØD		F	F1	L _{max}	L1	kg
4	0106 04 00	10	10	28	10	0.016
5	0106 05 00	11	12	31	11	0.023
6	0106 06 00	11	13	32	11	0.026
8	0106 08 00	13	14	36	10	0.031
10	0106 10 00	17	19	42	13	0.070
12	0106 12 00	19	22	42	13	0.092
14	0106 14 00	22	24	45	11	0.104
15	0106 15 00	22	24	45	11	0.097
16	0106 16 00	24	27	48	13	0.141
18	0106 18 00	27	30	53	14	0.186
20	0106 20 00	30	32	56	14	0.211
22	0106 22 00	32	36	60	14	0.283
25	0106 25 00	36	41	64	14	0.396
28	0106 28 00	41	42	64	14	0.399

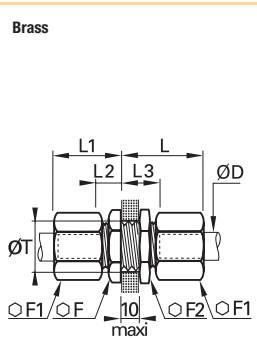
Brass Compression Fittings

0113 Equal Tube-to-Tube Connector with Mounting Boss



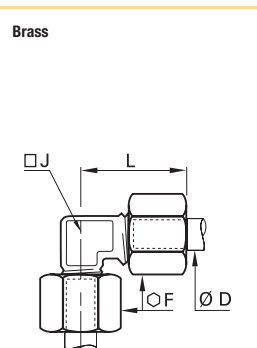
ØD		F	H	H1	L1	L/2	N	kg
4	0113 04 00	10	10.5	7	9.5	19	6	0.022
6	0113 06 00	13	13	9	10	20.5	7	0.033
8	0113 08 00	14	14.5	9.5	11	23.5	8	0.041
10	0113 10 00	19	19.5	12.5	11	26	9	0.082
12	0113 12 00	22	22	14	12	26.5	11	0.107
14	0113 14 00	24	25	16	11	28	12	0.122

0116 Equal Bulkhead Connector



ØD		F	F1	F2	L max	L1 max	L2	L3	ØT min	kg
4	0116 04 00	10	10	13	27	17	7	17	8.3	0.024
5	0116 05 00	13	12	14	28	18	7.5	17.5	10.3	0.035
6	0116 06 00	13	13	14	28	19	7.5	17.5	10.3	0.037
8	0116 08 00	14	14	17	29	20	7	17	12.3	0.045
10	0116 10 00	19	19	22	33	25	9	19	16.5	0.101
12	0116 12 00	22	22	22	33	25	9	19	18.5	0.121
14	0116 14 00	24	24	24	35	25	8	18	20.5	0.145
15	0116 15 00	24	24	24	35	25	8	18	20.5	0.134
16	0116 16 00	27	27	27	36	28	9.5	19.5	22.5	0.189
18	0116 18 00	27	30	30	40	30	10.5	20.5	24.5	0.237
20	0116 20 00	32	30	32	41	31	11	21	27.5	0.274
22	0116 22 00	36	36	36	42	32	11	21	30.5	0.372
25	0116 25 00	36	41	38	46	36	11	21	33.5	0.469


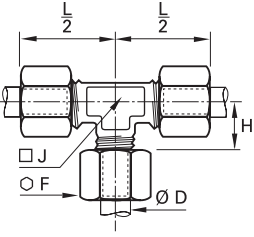

0102 Equal Elbow




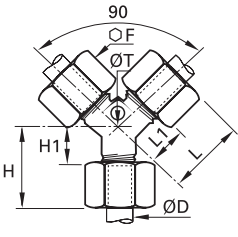

ØD		F	J	L max	kg
4	0102 04 00	10	5	19	0.016
5	0102 05 00	12	8	21	0.024
6	0102 06 00	13	8	22	0.027
8	0102 08 00	14	10	28	0.038
10	0102 10 00	19	12	30	0.073
12	0102 12 00	22	15	30	0.098
14	0102 14 00	24	19	35	0.133
15	0102 15 00	24	19	35	0.122
16	0102 16 00	27	19	39	0.164
18	0102 18 00	30	23	41	0.231
20	0102 20 00	32	23	42	0.233
22	0102 22 00	36	27	50	0.371
25	0102 25 00	41	27	54	0.446
28	0102 28 00	42	32	54.5	0.478

Brass Compression Fittings


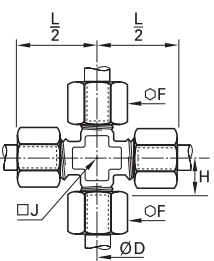

0104 Equal Tee

		ØD		F	H	J	L/2	kg
		4	0104 04 00	10	9.5	8	19	0.028
		5	0104 05 00	12	11	8	21	0.036
		6	0104 06 00	13	11	8	22	0.040
		8	0104 08 00	14	15	10	28	0.055
		10	0104 10 00	19	14.5	12	30	0.105
		12	0104 12 00	22	15	15	30	0.142
		14	0104 14 00	24	18	19	35	0.190
		15	0104 15 00	24	18	19	35	0.175
		16	0104 16 00	27	21	19	39	0.239
		18	0104 18 00	30	21.5	23	41	0.330
		20	0104 20 00	32	21.5	23	42	0.330
		22	0104 22 00	36	29	27	50	0.518
		25	0104 25 00	41	29	27	54	0.630
		28	0104 28 00	42	30	32	55	0.660

0142 Equal Y Piece with Mounting Boss

		ØD		F	H_{max}	H1	L_{max}	L1	ØT	Kg
		4	0142 04 00	10	16.5	7	26.5	17	4.2	0.032
		6	0142 06 00	13	19.5	8.5	28	17	4.2	0.049
		8	0142 08 00	14	21	8	30	17	6.2	0.061
		10	0142 10 00	19	24.5	9	37.5	22	6.2	0.128
		12	0142 12 00	22	26	11	38	23	6.2	0.110
		14	0142 14 00	24	28	11	41.5	24.5	6.2	0.201
		15	0142 15 00	24	28	11	41.5	24.5	6.2	0.204
		16	0142 16 00	27	30	12	43	25	6.2	0.252
		18	0142 18 00	30	31.5	12	50.5	31	10.2	0.220
		25	0142 25 00	41	39	14	59	34	10.2	0.728

0107 Equal Cross

		ØD		F	H	J	L/2	Kg
		4	0107 04 00	10	9.5	8	19	0.035
		5	0107 05 00	12	11	8	21	0.047
		6	0107 06 00	13	11	8	22	0.052
		8	0107 08 00	14	15	11	28	0.073
		10	0107 10 00	19	14.5	14	30	0.142
		12	0107 12 00	22	15	15	35	0.096
		14	0107 14 00	24	18	20	35	0.246
		15	0107 15 00	24	18	20	35	0.227
		16	0107 16 00	27	21	20	39	0.312
		18	0107 18 00	30	21.5	25	41	0.426
		20	0107 20 00	32	21.5	25	42	0.429
		22	0107 22 00	36	29	27	50	0.676
		25	0107 25 00	41	29	27	50	0.819

Complementary Brass Fittings Reducers, Olives and Nuts

This innovative reducer system, using a full range of nuts and olives, enables **different diameters** of steel, copper, brass or polymer tubes to be fitted onto **a single Parker Legris compression fitting**.

Product Advantages

Efficient Solution

Reduces envelope dimensions
Quick and easy to assemble, whatever the diameters and tube material
Improved stock management
Silicone-free

Multiple Combinations

A single connector for up to 4 different tube materials and sizes
Example:

- polymer tube 4 mm O.D.
- copper tube 8 mm O.D.
- brass tube 12 mm O.D.
- braided PVC hose 12 mm I.D.

 A full range of olives and nuts to optimise all assembly operations



Applications

Pneumatics
Cooling
Automotive Process
Lubrication
Fluid Transmission
Packaging
Industrial Machinery

Regulations

DI: 97/23/EC (PED)
RG: 1907/2006 (REACH)
DI: 2002/95/EC (RoHS)
DI: 94/9/EC (ATEX)

Reducer Assembly Procedure

Operation	Assembly Sequence	Assembled Fitting
<p>1 Assemble the reducer Place the reducer in the fitting body.</p>	<p>1</p>	
<p>2 Assemble the nut and olive Place the nut and then the olive onto the tube.</p>	<p>2</p>	
<p>3 Assemble the nut Push the tubing into the fitting until it butts against the tube reducer. Tighten the nut to the recommended torque (see opposite page).</p>	<p>3</p>	

Complementary Brass Fittings

Assembly Configuration

The table and information given below illustrate the large number of options available with Parker Legris brass compression fittings. To these must be added the advantages specific to the original Parker Legris reducer shown on the previous page.



Brass Body

0110 Brass			0110..60 Brass		0110..40 Steel	0110..70* Polymer
	0124 Brass	0111 BNA** Brass	0124 Brass	0111 BNA** Brass	0124...40 Steel	
No olive required to assemble the plug						No olive required to assemble the tube
Brass plug: 0126	Copper, cold-rolled brass, polymer tube and barb connectors 0122 and 0165	Coiled annealed copper tube	Cold-rolled copper tube for vibration and side loading, etc.	Coiled annealed copper tube for vibration and side loading, etc.	Steel or copper tube: low/medium hydraulic pressure, lubricate before assembly	Polymer tube

***Assembly specifications for nut-olive 0110 ..70**

This part functions as both olive and nut for flexible polymer tube assemblies:

1. Hand tighten the polymer nut-olive a few turns onto the body of the fitting; the knurling makes this easier.
2. Then introduce the polymer tube and push home into the body of the fitting.
3. Continue manually tightening the polymer nut-olive.
4. Finish tightening using a spanner until the nut body disengages and turns freely, which acts as a torque limiter.

N.B.: To avoid damaging the threads, do not insert the tube before hand tightening the nut-olive into the body of the fitting.

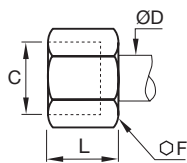
**Bureau de Normalisation de l'Automobile (French Automotive Bureau of Standards)

Recommended Tightening Torque

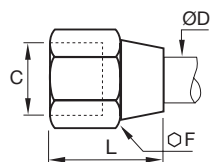
Tightening torque in daN.m =

maximum tightening torque of a **0110** nut and **0124** olive with copper, brass or steel tube.

Nut **0110** and **0110..40**



Nut **0110..60**



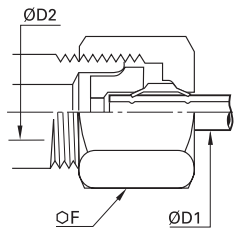
Ø D (mm)	OF 0110	OF 0110..60	max. daN.m copper or brass	OF 0110..40	max. daN.m steel
4	10	11	0.7	10	1.5
5	12	13	0.7	12	1.5
6	13	13	1.5	13	2.5
8	14	16	1.5	14	2.5
10	19	20	1.8	19	3
12	22	22	3	22	4.5
14	24	24	3.5	24	5.5
15	24	24	4	24	6
16	27	27	5	27	7
18	30	30	6	30	9
20	32	32	6	32	10
22	36	36	7	36	12
25	41	41	8	41	13
28	42		9		


Complementary Brass Compression Fittings

0166 3-Piece Reducer



Brass


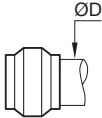



ØD1	ØD2		F	kg
4	5	0166 04 05	13	0.011
	6	0166 04 06	13	0.011
	8	0166 04 08	14	0.012
	10	0166 04 10	19	0.031
	12	0166 04 12	22	0.044
	14	0166 04 14	24	0.054
5	15	0166 04 15	24	0.056
	6	0166 05 06	13	0.010
	8	0166 05 08	14	0.012
	10	0166 05 10	19	0.030
	12	0166 05 12	22	0.044
	14	0166 05 14	24	0.053
6	16	0166 05 16	27	0.078
	8	0166 06 08	14	0.012
	10	0166 06 10	19	0.030
	12	0166 06 12	22	0.043
	14	0166 06 14	24	0.052
	15	0166 06 15	24	0.054
8	16	0166 06 16	27	0.077
	10	0166 08 10	19	0.027
	12	0166 08 12	22	0.040
	14	0166 08 14	24	0.051
	15	0166 08 15	24	0.053
	16	0166 08 16	27	0.076
10	18	0166 08 18	30	0.100
	12	0166 10 12	22	0.037
	14	0166 10 14	24	0.045
	15	0166 10 15	24	0.047
	16	0166 10 16	27	0.068
	18	0166 10 18	30	0.095
12	20	0166 10 20	32	0.107
	22	0166 10 22	36	0.144
	25	0166 10 25	41	0.209
	14	0166 12 14	24	0.043
	15	0166 12 15	24	0.043
	16	0166 12 16	27	0.066
14	18	0166 12 18	30	0.092
	20	0166 12 20	32	0.102
	22	0166 12 22	36	0.140
	25	0166 12 25	41	0.200
	16	0166 14 16	27	0.060
	18	0166 14 18	30	0.084
15	20	0166 14 20	32	0.095
	22	0166 14 22	36	0.133
	25	0166 14 25	41	0.189
	18	0166 15 18	30	0.081
16	22	0166 15 22	36	0.130
	18	0166 16 18	30	0.078
	20	0166 16 20	32	0.088
	22	0166 16 22	36	0.126
18	25	0166 16 25	41	0.185
	20	0166 18 20	32	0.082
	22	0166 18 22	36	0.118
	25	0166 18 25	41	0.180
20	28	0166 18 28	42	0.176
	25	0166 20 25	41	0.168
22	28	0166 22 28	42	0.168


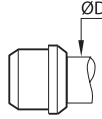

ØD1: tube to be fitted
 ØD2: for an x mm Ø fitting
 Each of the above part numbers comprises:
 - a reduction piece
 - an olive, PN 0124
 - a sleeve nut

Complementary Brass Compression Fittings


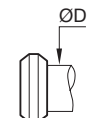

0124 Brass Olive

	Brass 	ØD		kg
		4	0124 04 00	0.001
		5	0124 05 00	0.001
		6	0124 06 00	0.001
		8	0124 08 00	0.001
		10	0124 10 00	0.003
		12	0124 12 00	0.004
		14	0124 14 00	0.005
		15	0124 15 00	0.004
		16	0124 16 00	0.006
		18	0124 18 00	0.007
		20	0124 20 00	0.009
		22	0124 22 00	0.012
		25	0124 25 00	0.017
28	0124 28 00	0.017		

0124..40 Steel Olive


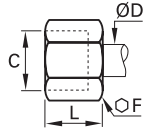

	Zinc-plated steel 	ØD		kg
		4	0124 04 00 40	0.001
		6	0124 06 00 40	0.001
		8	0124 08 00 40	0.001
		10	0124 10 00 40	0.003
		12	0124 12 00 40	0.003
		14	0124 14 00 40	0.005
		15	0124 15 00 40	0.004
		16	0124 16 00 40	0.006
		18	0124 18 00 40	0.007
		20	0124 20 00 40	0.007
		22	0124 22 00 40	0.010
		25	0124 25 00 40	0.014

0111 BNA* Brass Olive


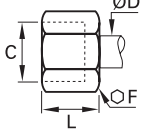

	Brass 	ØD		kg
		4	0111 04 00	0.001
		5	0111 05 00	0.001
		6	0111 06 00	0.001
		8	0111 08 00	0.001
		10	0111 10 00	0.002
		12	0111 12 00	0.002
		14	0111 14 00	0.003
		15	0111 15 00	0.003
		16	0111 16 00	0.003
*BNA: Bureau de Normalisation de l'Automobile (standards organization in the field of Automotive Process)				

Complementary Brass Compression Fittings


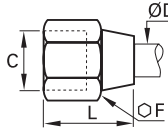

0110 Brass Nut

	Brass		ØD	C		F	L	kg
			4	M8x1	0110 04 00	10	11	0.005
			5	M10x1	0110 05 00	12	11	0.006
			6	M10x1	0110 06 00	13	11	0.008
			8	M12x1	0110 08 00	14	13	0.008
			10	M16x1.5	0110 10 00	19	15	0.019
			12	M18x1.5	0110 12 00	22	15	0.026
			14	M20x1.5	0110 14 00	24	15	0.029
			15	M20x1.5	0110 15 00	24	15	0.028
			16	M22x1.5	0110 16 00	27	17	0.042
			18	M24x1.5	0110 18 00	30	18	0.057
			20	M27x1.5	0110 20 00	32	18	0.057
			22	M30x1.5	0110 22 00	36	19	0.078
			25	M33x1.5	0110 25 00	41	21	0.121
28	M36x1.5	0110 28 00	42	21	0.110			


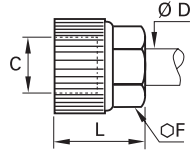

0110..40 Steel Nut

	Zinc-plated steel		ØD	C		F	L	kg
			4	M8x1	0110 04 00 40	10	11	0.004
			5	M10x1	0110 05 00 40	12	11.5	0.005
			6	M10x1	0110 06 00 40	13	12	0.008
			8	M12x1	0110 08 00 40	14	13.5	0.008
			10	M16x1.5	0110 10 00 40	19	16	0.018
			12	M18x1.5	0110 12 00 40	22	16.5	0.027
			14	M20x1.5	0110 14 00 40	24	17	0.030
			15	M20x1.5	0110 15 00 40	24	17	0.029
			16	M22x1.5	0110 16 00 40	27	18	0.042
			18	M24x1.5	0110 18 00 40	30	19	0.056
			20	M27x1.5	0110 20 00 40	32	20.5	0.061
			22	M30x1.5	0110 22 00 40	36	21.5	0.085

0110..60 Brass Long Nut

	Brass		ØD	C		F	L	kg
			4	M8x1	0110 04 00 60	11	14.5	0.007
			5	M10x1	0110 05 00 60	13	17	0.008
			6	M10x1	0110 06 00 60	13	17.5	0.011
			8	M12x1	0110 08 00 60	16	20	0.019
			10	M16x1.5	0110 10 00 60	20	23	0.032
			12	M18x1.5	0110 12 00 60	22	25	0.039
			14	M20x1.5	0110 14 00 60	24	30	0.051
			15	M20x1.5	0110 15 00 60	24	30	0.049
			16	M22x1.5	0110 16 00 60	27	32	0.070
			18	M24x1.5	0110 18 00 60	30	35	0.098
			20	M27x1.5	0110 20 00 60	32	35	0.102
			22	M30x1.5	0110 22 00 60	36	36	0.129

0110..70 Technical Polymer Nut-Olive

	Technical polymer		ØD	C		F	L	kg
			4	M8x1	0110 04 00 70	8	13	0.008
			6	M10x1	0110 06 00 70	11	15	0.002
			8	M12x1	0110 08 00 70	13	16	0.002
			10	M16x1.5	0110 10 00 70	17	19	0.004
			12	M18x1.5	0110 12 00 70	19	19	0.005
			14	M20x1.5	0110 14 00 70	22	20	0.005
16	M22x1.5	0110 16 00 70	24	21	0.008			

NB: polymer nut-olives should not be used on metal tubing.



Brass Compression Fittings

Compression Fittings

Self-Fastening Barb Connectors for NBR Hose

This range of fittings is designed to meet the requirements of the automotive and robotics industries, combining as it does **optimum CNOMO manufacturing quality**, simple installation, reliable operation and a **long service life**.

Product Advantages

Perfect for Self-Fastening NBR Hose

- Quick and simple to install
- Compatible with the Parker Legris range of brass compression fittings
- Mechanical properties proven for use in industrial robotic installations
- Spark-resistant

Ergonomic and Time-Saving

- Fitting does not require lubrication or clamping, reducing assembly time
- Visual stop confirms installation is correct and improves operating safety
- Removal by cutting the tube
- The fitting can be re-used if necessary



Applications

Welding Robots
Pneumatics
Compressed Air Systems
Automotive Process
Cooling

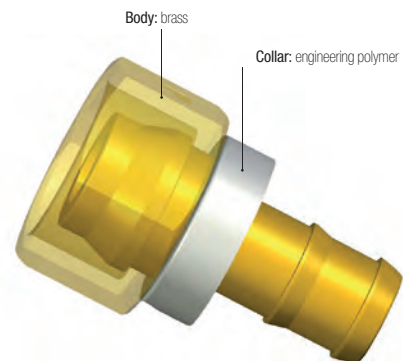
Technical Characteristics

Compatible Fluids	Coolants, compressed air						
Working Pressure	0 to 16 bar						
Working Temperature	0°C to +100°C (water) -20°C to +70°C (air)						

Tightening Torque, Type 0132	DN	6	8	10	14	18	22
	daN.m	0.7	1.5	1.8	3.5	6	7

Reliable performance is dependent upon the type of fluid conveyed and hose being used.

Component Materials



Silicone-free

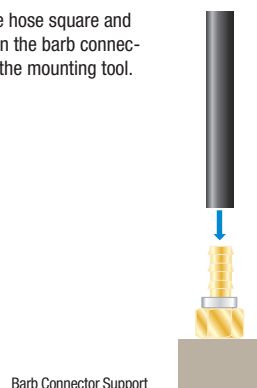
Self-Fastening Hose Assembly Machine

Machine designed to assemble a barb connector and a self-fastening NBR hose.
Machine part number: **0650 00 00 05**



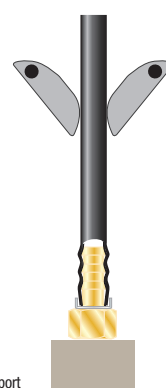
Tube Cutting and Positioning

Cut the hose square and position the barb connector on the mounting tool.



Press-Fitting the Tube

Activate the press-fit tool; connection is complete when the tube is fully home on the barb connector. This tool has been designed for use with 5 different diameters and is easy to operate.


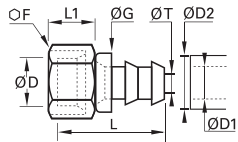



Regulations

Industrial
DI: 2002/95/EC (RoHS), 2011/65/EC
DI: 97/23/EC (PED)
RG: 1907/2006 (REACH)
CNOMO: E07.21.115N


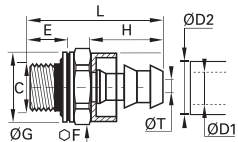

Self-Fastening Barb Connectors for NBR Hose

0132 Self-Fastening Barb Connector for Brass Compression Fitting

	<p>Brass</p> 	ØD	ØD1	ØD2		F	G	L	L1	ØT	kg
		6	6.3	13	0132 06 56	12	16.5	32.5	12.5	4.8	0.010
		8	6.3	13	0132 08 56	14	16.5	29.5	11.5	4.8	0.015
		10	6.3	13	0132 10 56	19	16.5	30	14	4.8	0.028
			9.5	16	0132 10 60	19	19.5	34	14	7.5	0.030
		14	9.5	16	0132 14 60	24	19.5	35.5	15	7.5	0.050
			12.7	19	0132 14 62	24	23.5	39.5	15	10	0.054
		18	12.7	19	0132 18 62	30	23.5	41.5	17	10	0.090
			15.9	23	0132 18 66	30	27	50	17	13.5	0.090
		22	19.1	27	0132 22 69	36	30.5	56.5	17	16	0.128


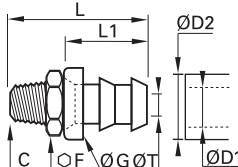

Polymer collar

0133..39 Self-Fastening Barb Connector with Bi-Material Seal, Male BSPP Thread

	<p>Brass, zinc-plated steel with NBR seal</p> 	ØD1	ØD2	C		E	F	G	H	L	ØT	kg
		6.3	13	G1/8	0133 56 10 39	5.5	13	14	20	31.5	4.8	0.012
			13	G1/4	0133 56 13 39	7	17	17	20	33.5	4.8	0.018
		9.5	16	G1/4	0133 60 13 39	7	17	17	24	37.5	7.5	0.022
			16	G3/8	0133 60 17 39	9.5	22	22	24	42.5	7.5	0.038
		12.7	19	G3/8	0133 62 17 39	9.5	22	22	28	46.5	10	0.045
			19	G1/2	0133 62 21 39	10.5	27	26	28	48.5	10	0.060
		15.9	23	G1/2	0133 66 21 39	10.5	27	26	36.5	57	13.5	0.064
			23	G3/4	0133 66 27 39	11.5	32	32	36.5	59	13.5	0.095
		19.1	27	G3/4	0133 69 27 39	11.5	32	32	43	65.5	16	0.111

Thread with bi-material seal and polymer collar.
Bi-material sealing washer part number 0139 can be found in Chapter 9.

0134 Self-Fastening Barb Connector, Male BSPT Thread

	<p>Brass</p> 	ØD1	ØD2	C		F	G	L	L1	ØT	kg
		6.3	13	R1/8	0134 56 10	14	16.5	32.5	20	4.8	0.015
			13	R1/4	0134 56 13	14	16.5	37	20	4.8	0.020
		9.5	16	R1/4	0134 60 13	14	19.5	41	24	7.5	0.022
			16	R3/8	0134 60 17	19	19.5	41.5	24	7.5	0.036
		12.7	19	R3/8	0134 62 17	19	23.5	45.5	28	10	0.038
			19	R1/2	0134 62 21	22	23.5	50	28	10	0.062
		15.9	23	R1/2	0134 66 21	22	27	58.5	36.5	13.5	0.056
			23	R3/4	0134 66 27	27	27	60.5	36.5	13.5	0.101
		19.1	27	R3/4	0134 69 27	27	30.5	67	43	16	0.108

Polymer collar

Self-fastening NBR hose is selected by nominal diameter; for example:

Barb Connector	O.D. (Tube)	Ø DN (Tube)	Self-Fastening NBR hose
0132 10 56	10	1/4	10..H 56...



Brass Adaptors

0122 Barb Connector for Hose

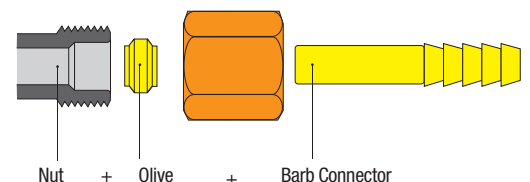
ØD1	ØD2	L	L1	ØT min	kg	Brass	
						ØD3	L
4	4	0122 04 04	6	37.5	22.5	3	0.004
5	4	0122 05 04	6	37.5	22.5	3	0.003
6	4	0122 06 04	6	37.5	22.5	3	0.005
	7	0122 06 07	9	37.5	22.5	6	0.007
8	6	0122 08 06	8	40	22.5	5	0.007
	7	0122 08 07	9	40	22.5	6	0.008
	10	0122 08 10	12.5	40	22.5	9	0.013
10	7	0122 10 07	9	43	22.5	6	0.010
	10	0122 10 10	12.5	43	22.5	9	0.014
12	10	0122 12 10	12.5	43	22.5	9	0.014
	13	0122 12 13	15	50	29.5	12	0.018
14	13	0122 14 13	15	52	29.5	12	0.019
	16	0122 14 16	18.5	60.5	38	15	0.308
15	13	0122 15 13	15	52	29.5	12	0.019
	16	0122 15 16	18.5	60.5	38	15	0.032
16	13	0122 16 13	15	53.5	29.5	12	0.021
	16	0122 16 16	18.5	62	38	15	0.032
18	16	0122 18 16	18.5	62	38	15	0.032
	19	0122 18 19	21.5	62	38	18	0.041
20	16	0122 20 16	18.5	64	38	15	0.034
	19	0122 20 19	21.5	64	38	18	0.038
22	19	0122 22 19	21.5	64	38	18	0.039
	19	0122 25 19	21.5	70	38	18	0.049
25	25	0122 25 25	27.5	70	38	24	0.054
28	25	0122 28 25	27.5	70	38	24	0.087

0165 Barb Connector for Flexible Tubing

ØD1	ØD2	L	L1	ØT min	kg	Brass	
						ØD3	L
4	4	0165 04 06	4.3	30	15	2	0.002
5	4	0165 05 06	4.3	30	15	2	0.010
	4	0165 06 06	4.3	30	15	2	0.003
6	6	0165 06 08	6.4	30	15	4	0.004
	8	0165 06 10	8.4	30	15	4	0.004
8	6	0165 08 08	6.4	32.5	15	4	0.006
	8	0165 08 10	8.4	32.5	15	6	0.006
	10	0165 08 12	10.7	37.5	20	8	0.009
10	8	0165 10 10	8.4	35.5	15	6	0.008
	10	0165 10 12	10.7	40.5	20	8	0.010
12	12	0165 10 14	12.7	40.5	20	8	0.012
	10	0165 12 12	10.7	40.5	20	8	0.011
12	12	0165 12 14	12.7	40.5	20	10	0.013
	14	0165 14 14	12.7	42.5	20	10	0.014
15	13	0165 15 16	13.7	42.5	20	11	0.016
16	13	0165 16 16	13.7	44	20	11	0.018


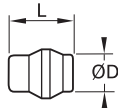

Assembly: Barb Connectors

Our barb connectors 0122 and 0165 are designed to be used with different types of hose. They are secured using the nut and olive provided with the fitting.




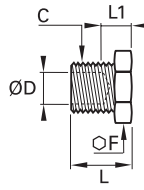

Brass Adaptors

0126 Plug for Compression Fitting

	Brass		ØD		L	kg
			4	0126 04 00	10	0.001
			5	0126 05 00	10	0.003
			6	0126 06 00	10	0.003
			8	0126 08 00	11.5	0.006
			10	0126 10 00	13	0.010
			12	0126 12 00	13	0.014
			14	0126 14 00	13.5	0.020
			15	0126 15 00	13.5	0.022
			16	0126 16 00	16	0.029
			18	0126 18 00	16	0.039
			20	0126 20 00	16	0.045
			22	0126 22 00	18	0.003
			28	0126 28 00	19.5	0.108


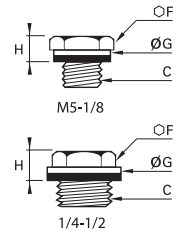

The plug is used to blank off an outlet in a compression fitting, replacing the olive.
When an open outlet is required, simply dismantle and replace the plug with the tube olive, reusing the nut.
The plug is also reusable.

0125 Tube End Plug for Compression Fitting

	Brass		ØD	C		F	L	L1	kg
			4	M8x1	0125 04 00	10	12	8	0.006
			6	M10x1	0125 06 00	11	13.5	9.5	0.008
			8	M12x1	0125 08 00	14	14	9	0.013
			10	M16x1.5	0125 10 00	17	18	11	0.025
			12	M18x1.5	0125 12 00	19	18	11	0.030
			14	M20x1.5	0125 14 00	22	19	11	0.041


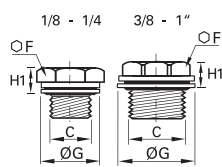

This plug enables unused tubes to be blanked off.
The male thread on the plug has the same pitch as the female thread on the sleeve nut of a standard Parker Legris fitting.
Therefore the plug screwed into the sleeve nut blanks off the tube.
To reopen the passage, simply unscrew the plug and fit the required coupler.
No further treatment of the tube is required.

0220 Hex Head Plug with Captive Sealing Washer, Male BSPP and Metric Thread

	Brass, technical polymer		C		F	G	H	kg
			M5x0.8	0220 19 00	8	8	5	0.002
			G1/8	0220 10 00	14	14	7.5	0.011
			G1/4	0220 13 00	17	17	7.5	0.019
			G3/8	0220 17 00	17	22	8.5	0.024
			G1/2	0220 21 00	22	27	10	0.040

Thread with pre-assembled washer.
M5: with screwdriver slot for tightening.
Maximum allowable working pressure = 20 bar.
Part number with suffix 99, maximum allowable working pressure = 250 bar, example: 0220 19 00 99.
Conforms to BNA 229 (with the exception of M5 model): BSPP thread, ISO ISO 228-1; metric thread, ISO NFE 03-054.

0220..39 Hex Head Plug with Bi-Material Seal, Male BSPP Thread

	Brass, zinc-plated steel with NBR seal		C		F	G	H1	kg
			G1/8	0220 10 00 39	14	14	6.5	0.012
			G1/4	0220 13 00 39	17	17	6.5	0.020
			G3/8	0220 17 00 39	17	22	8	0.025
			G1/2	0220 21 00 39	22	26	9	0.043
			G3/4	0220 27 00 39	22	32	10	0.060
			G1	0220 34 00 39	27	39.5	10.5	0.089

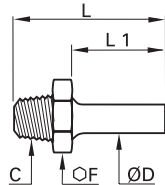
Plug with bi-material seal.
Bi-material washers part number 0139 can be found in Chapter 9.

Brass Adaptors

0120 Stud Standpipe, Male BSPT Thread



Brass

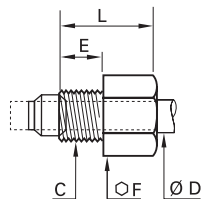


ØD	C		F	L	L1	kg
4	R1/8	0120 04 10	11	25.5	14	0.007
5	R1/8	0120 05 10	11	26	14.5	0.007
6	R1/8	0120 06 10	11	26.5	15	0.008
	R1/4	0120 06 13	14	31	15	0.015
8	R1/8	0120 08 10	11	28.5	17	0.009
	R1/4	0120 08 13	14	33	17	0.016
	R3/8	0120 08 17	17	33.5	17	0.020
10	R1/4	0120 10 13	14	36	20	0.018
	R3/8	0120 10 17	17	36.5	20	0.022
	R1/2	0120 10 21	22	41	20	0.038
12	R1/4	0120 12 13	14	36	20	0.018
	R3/8	0120 12 17	17	36.5	20	0.022
14	R1/2	0120 12 21	22	41	20	0.041
	R3/8	0120 14 17	17	38	21.5	0.024
15	R1/2	0120 14 21	22	42.5	21.5	0.041
	R3/8	0120 15 17	17	38	21.5	0.023
16	R1/2	0120 15 21	22	42.5	21.5	0.041
	R3/8	0120 16 17	17	39.5	23	0.024
18	R1/2	0120 16 21	22	44	23	0.042
	R3/4	0120 18 21	27	44.5	23.5	0.042
20	R3/4	0120 18 27	27	47.5	23.5	0.071
	R3/4	0120 20 27	27	49	25	0.071
22	R3/4	0120 22 27	27	48.5	25.5	0.067
	R1	0120 22 34	36	52.5	25.5	0.116
25	R1	0120 25 34	36	57	30	0.119
28	R1	0120 28 34	36	57	30	0.138

0112 Sleeve Nut for Compression Fitting, Male Metric Thread



Brass


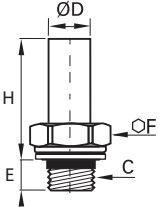



ØD	C		E	F	L	kg
4	M8x1	0112 04 00	7	10	13	0.005
5	M10x1	0112 05 00	7.5	11	13.5	0.007
6	M10x1	0112 06 00	7.5	11	13.5	0.006
8	M12x1	0112 08 00	8	13	15	0.008
10	M16x1.5	0112 10 00	11	17	18	0.018
12	M18x1.5	0112 12 00	11	19	18	0.021
14	M20x1.5	0112 14 00	11	22	18	0.026

This product was designed to allow the tube to be fitted directly into the tapped port in a body using a standard Parker Legris olive.
For the corresponding drawings (cavity for Parker Legris olive), please consult us.


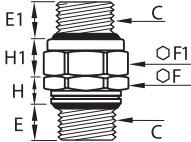

Brass Adaptors

0128..39 Stud Standpipe with Bi-Material Seal, Male BSPP Thread

	Brass, zinc-plated steel with NBR seal		ØD	C		E	F	H	Kg
			4	G1/8	0128 04 10 39	7.5	13	20	0.009
				G1/4	0128 04 13 39	9	17	22	0.015
			6	G1/8	0128 06 10 39	7.5	13	21	0.010
				G1/4	0128 06 13 39	9	17	23	0.016
			8	G1/8	0128 08 10 39	7.5	13	23	0.011
				G1/4	0128 08 13 39	9	17	25	0.017
				G3/8	0128 08 17 39	12	22	26	0.033
				G1/4	0128 10 13 39	9	17	28	0.018
			10	G3/8	0128 10 17 39	12	22	29	0.034
				G1/2	0128 10 21 39	27	27	30	0.048
			14	G3/8	0128 14 17 39	12	22	30.5	0.035
				G1/2	0128 14 21 39	27	27	31.5	0.049
			18	G1/2	0128 18 21 39	27	27	33.5	0.052
				G3/4	0128 18 27 39	14	32	34.5	0.084
			22	G3/4	0128 22 27 39	14	32	36.5	0.082
				G1	0128 22 34 39	16.5	41	38	0.123
			28	G1	0128 28 34 39	16.5	41	42.5	0.149


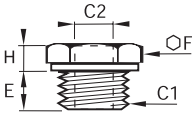

With bi-material seal.
Bi-material washers part number 0139 can be found in Chapter 9.

0151..39 Straight Male Orientable Adaptor, with Bi-Material Seal, Male BSPP Thread

	Brass, NBR, zinc-plated steel with NBR seal		C		E	E1	F	F1	H	H1	kg
			G1/8	0151 10 10 39	5.5	7	13	14	6	6.5	0.017
			G1/4	0151 13 13 39	7	8.5	17	19	6.5	9	0.036
			G3/8	0151 17 17 39	9.5	9.5	22	22	9	9	0.057
			G1/2	0151 21 21 39	10.5	10.5	27	27	10	10	0.083
			G3/4	0151 27 27 39	11.5	11.5	32	32	11	10	0.121
			G1	0151 34 34 39	13	13.5	41	41	12.5	10.5	0.230

With bi-material seal.
Bi-material washers part number 0139 can be found in Chapter 9.

0168..39 Reducer, with Bi-Material Seal, Male BSPP Thread/Female BSPP and Metric Thread

	Brass, zinc-plated steel with NBR seal		C1	C2		E	F	H	kg
			G1/8	M5x0.8	0168 10 19 39	8	14	4.5	0.009
			G1/4	M5x0.8	0168 13 19 39	8	17	5	0.018
				G1/8	0168 13 10 39	8	17	5	0.012
			G3/8	G1/8	0168 17 10 39	10	19	5	0.020
				G1/4	0168 17 13 39	10	19	5	0.013
				G1/8	0168 21 10 39	12	24	7.5	0.052
			G1/2	G1/4	0168 21 13 39	12	24	7.5	0.043
				G3/8	0168 21 17 39	12	24	7.5	0.030
				G1/4	0168 27 13 39	12	32	9.5	0.099
			G3/4	G3/8	0168 27 17 39	12	32	9.5	0.086
				G1/2	0168 27 21 39	12	32	9.5	0.065

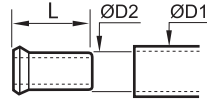
With bi-material seal.
Bi-material washers part number 0139 can be found in Chapter 9.


Brass Adaptors

0127 Tube Support for Polymer Tubing



Brass



	ØD1	ØD2		L	kg
4	2		0127 04 00	11	0.001
	2.7		0127 04 27	11	0.001
5	3		0127 05 03	11	0.001
	3.3		0127 05 00	11.5	0.009
6	4		0127 06 00	11.5	0.001
8	5.5		0127 08 55	14	0.001
	6		0127 08 00	14	0.001
10	7		0127 10 07	18	0.001
	7.5		0127 10 75	18	0.001
12	8		0127 12 00	18	0.002
	8		0127 12 08	18	0.002
14	9		0127 12 09	18	0.002
	10		0127 12 00	18	0.001
15	11		0127 14 11	18	0.002
	12		0127 14 00	18	0.002
16	12		0127 15 12	18	0.002
18	13		0127 16 13	18	0.003
20	14		0127 18 14	19.5	0.003
22	15		0127 20 15	20.5	0.003
25	16		0127 22 16	21	0.004
	19		0127 25 19	25	0.007

This tube support guarantees good gripping, at high temperatures and pressures, by preventing collapsing of the tube.

Stainless Steel Compression Fitting Range

Stainless Steel Fittings

Stud Fittings

- | | | | | | | |
|----------------------------------|---------------------------------|----------------------------------|----------------------------------|---------------------------------|----------------------------------|---------------------------------|
| 1805
BSPT
Page 5-34 | 1805
NPT
Page 5-34 | 1814
BSPP
Page 5-34 | 1809
BSPT
Page 5-35 | 1809
NPT
Page 5-35 | 1820
BSPT
Page 5-35 | 1820
NPT
Page 5-35 |
|----------------------------------|---------------------------------|----------------------------------|----------------------------------|---------------------------------|----------------------------------|---------------------------------|



Tube-to-Tube Fittings

- | | | | |
|--------------------------|--------------------------|--------------------------|--------------------------|
| 1806
Page 5-36 | 1816
Page 5-36 | 1802
Page 5-36 | 1804
Page 5-36 |
|--------------------------|--------------------------|--------------------------|--------------------------|



Complementary Fittings

- | | | |
|--------------------------|--------------------------|--------------------------|
| 1866
Page 5-39 | 1824
Page 5-39 | 1810
Page 5-39 |
|--------------------------|--------------------------|--------------------------|



Accessories

- | | |
|--------------------------|--------------------------|
| 1822
Page 5-39 | 1827
Page 5-39 |
|--------------------------|--------------------------|



Stainless Steel Compression Fittings

Manufactured in 316L stainless steel, these fittings combine all the advantages of the "universal" compression fitting with **excellent resistance** to environmental conditions and **corrosive fluids**. They are pressure and temperature-resistant and are able to withstand strong vibration and water hammer.

Product Advantages

For Use in Many Environments

- Manufactured in 316L stainless steel
- Suitable for all environments and fluids
- Resistant to water hammer and vibration
- Excellent sealing and retention of the tube
- Suitable for pneumatic and medium pressure hydraulic applications
- Metallic sealing guarantees maximum service life

Many Tube Options

- Possibility of easily connecting different tube materials and diameters to the same fitting body
- No tube support required for rigid and semi-rigid polyamide tubing below 12 mm



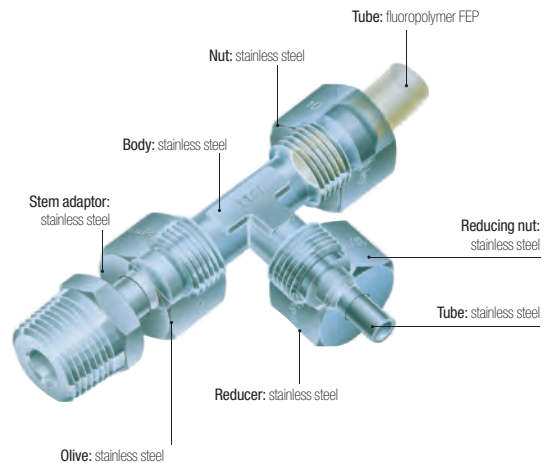
- Applications**
- Food Process
 - Fluid Transmission
 - Pneumatics
 - Automotive Process
 - Petrochemical
 - Chemical
 - Offshore Oil & Gas

Technical Characteristics

Compatible Fluids	Many fluids					
Working Pressure	Vacuum to 400 bar (80 bar in corrosive environments)					
Working Temperature	-40°C to +250°C					
Tightening Torques	DN	6	8	10	12	16
	daN.m	2	3	4	6.5	9.5

Reliable performance is dependent upon the type of fluid conveyed and tubing being used. Guaranteed for use with a vacuum of 755 mm Hg (99% vacuum).

Component Materials



Silicone-free

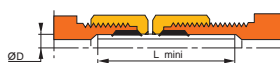
Maximum Bore Diameters

The table below shows the recommended compatibility of tube size, BSPP male thread and maximum bore.

Tube O.D	BSPP Thread	Max. Bore
6	G1/8	4
6-8-10	G1/4	7
10-12	G3/8	11
16	G1/2	14

Tube Length for Assembly

Minimum length of tube (L) between 2 fittings.



ØD	L mm	ØD	L mm
4	26.5	10	39
6	26	12	39
8	32	16	46.5

Regulations

- DI: 2002/95/EC (RoHS), 2011/65/EC
- DI: 97/23/EC (PED)
- RG: 1935/2004
- RG: 1907/2006 (REACH)
- DI: 94/09/EC (ATEX)
- FDA: 21 CFR 177.1550
- NACE MR0175: compatible materials
- ISO 15156-1/-2/-3: compatible materials

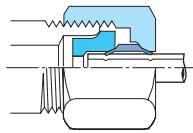
Stainless Steel Compression Fittings

Installation

Fitting

The fitting comprises three parts (body/olive/nut). For assembly procedure, please see Brass Compression Fitting page.

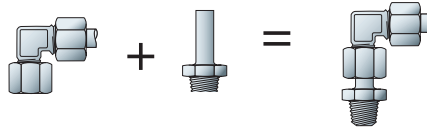
Diagram: Assembled Fitting



A very slight distortion of the tube appears; this shows the fitting has been correctly tightened.

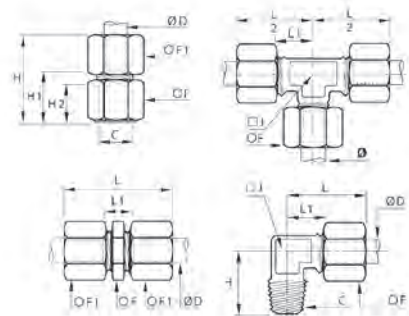
Orientable Elbow Assembly

Elbow **1802** + Adaptor **1820** =



Customised Fittings

If our standard range does not meet your needs, Parker Legris can develop customised solutions for your applications.



Technical Characteristics

The use of Parker Legris stainless steel compression fittings is dependant on the tube material. Tables of recommended working pressure for the different tubes are shown below.

Recommended Tube Type

Semi-rigid polyamide or fluoropolymer tube

Stainless steel tube

"Thin Wall" cold-drawn seamless, annealed and passivated: wall thickness tolerance +/-0.1 mm. For use with "thin wall" stainless steel tube from 6 mm to 16 mm O.D., maximum wall thickness 1 mm.

Recommended Tube/Fitting Assembly Configurations

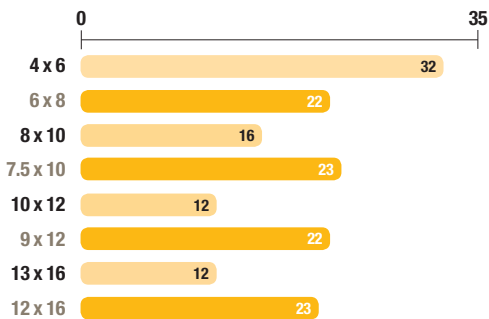
Assembled using Parker Legris olive and nut in stainless steel, with a tube support.

Stainless steel tube

Stainless steel tube: in cold-rolled straight lengths
Coiled annealed stainless tube: reduces working pressure by 35%; do not use if there is vibration.

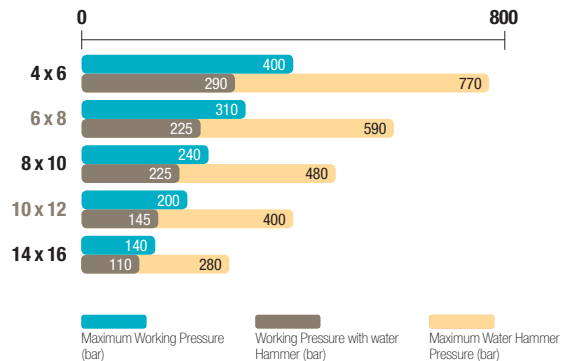
Semi-Rigid Polyamide Tube

Maximum Working Pressure (bar)



Stainless Steel Tube

Maximum Working Pressure (bar)




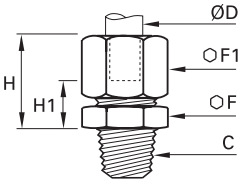

Working Pressure Coefficients for Semi-Rigid Tubing

Temperature °C	-40°C / -15°C	-15°C / +30°C	+30°C / +50°C	+50°C / +70°C	+70°C / +100°C
Factor	1.8	1	0.68	0.55	0.31


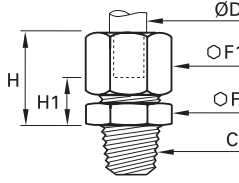

The above recommendations are given in good faith. However, since each application is different, it is advisable to undertake tests in actual working conditions.

Stainless Steel Compression Fittings


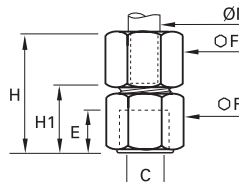

1805 Stud Fitting, Male BSPT Thread

	Stainless steel 316L		ØD	C		F	F1	H max	H1	kg
			6	R1/8	1805 06 10	12	13	19.5	7.5	0.017
			R1/4	1805 06 13	14	13	19.5	7.5	0.025	
			8	R1/8	1805 08 10	13	14	21	7	0.019
			R1/4	1805 08 13	14	14	21	7	0.024	
			10	R1/4	1805 10 13	17	19	25.5	9	0.044
			R3/8	1805 10 17	17	19	25.5	9	0.049	
			R1/2	1805 10 21	22	19	26.5	10	0.076	
			12	R1/4	1805 12 13	19	22	26	9	0.054
			R3/8	1805 12 17	19	22	26	9	0.058	
			R1/2	1805 12 21	22	22	27	10	0.081	
			16	R3/8	1805 16 17	24	27	28.5	9.5	0.086
			R1/2	1805 16 21	24	27	28.5	9.5	0.094	

1805 Stud Fitting, Male NPT Thread


	Stainless steel 316L		ØD	C		F	F1	H max	H1	kg
			6	NPT1/8	1805 06 11	12	13	19.5	7.5	0.018
			NPT1/4	1805 06 14	14	13	19.5	7.5	0.027	
			NPT3/8	1805 06 18	19	13	20.5	8.5	0.033	
			NPT1/2	1805 06 22	22	13	21.5	9.5	0.049	
			8	NPT1/8	1805 08 11	13	14	21	7	0.020
			NPT1/4	1805 08 14	14	14	21	7	0.027	
			10	NPT1/4	1805 10 14	17	19	25.5	9	0.045
			NPT3/8	1805 10 18	19	19	25.5	9	0.055	
			NPT1/2	1805 10 22	22	19	26.5	10	0.083	
			12	NPT1/4	1805 12 14	19	22	26	9	0.056
			NPT3/8	1805 12 18	19	22	26	9	0.061	
			NPT1/2	1805 12 22	22	22	27	10	0.087	
			16	NPT3/8	1805 16 18	24	27	28.5	9.5	0.087
			NPT1/2	1805 16 22	24	27	28.5	9.5	0.097	

1814 Stud Fitting, Female BSPP Thread


	Stainless steel 316L		ØD	C		E	F	F1	H max	H1	kg
			6	G1/8	1814 06 10	7.5	14	13	29	17	0.023
			G1/4	1814 06 13	11	17	13	29	21	0.032	
			8	G1/4	1814 08 13	11	17	14	34.5	20.5	0.033
			10	G3/8	1814 10 17	11.5	22	19	38.5	22	0.064
			G1/2	1814 10 21	15	27	19	43	26.5	0.093	
			12	G3/8	1814 12 17	11.5	22	22	39	22	0.072
			G1/2	1814 12 21	15	27	22	43.5	26.5	0.100	
			16	G1/2	1814 16 21	15	27	27	45	26	0.120

Stainless Steel Compression Fittings


1809 Stud Elbow, Male BSPT Thread

ØD	C		F	H	J	L _{max}	L1	kg
6	R1/8	1809 06 10	13	18	8	25.5	13.5	0.021
	R1/4	1809 06 13	13	23	10	25.5	13.5	0.030
8	R1/8	1809 08 10	14	20.5	10	28.5	14.5	0.027
	R1/4	1809 08 13	14	23	10	28.5	14.5	0.031
10	R1/4	1809 10 13	19	25	12	32.5	16	0.050
	R3/8	1809 10 17	19	25.5	12	32.5	16	0.058
12	R1/2	1809 10 21	19	32	18	36.5	20	0.091
	R1/4	1809 12 13	22	26	14	34	17	0.067
16	R3/8	1809 12 17	22	27	14	34	17	0.070
	R1/2	1809 12 21	22	32	18	37	20	0.098
16	R3/8	1809 16 17	27	28.5	18	39.5	21	0.107
	R1/2	1809 16 21	27	31.5	18	39.5	21	0.114


1809 Stud Elbow, Male NPT Thread

ØD	C		F	H	J	L _{max}	L1	kg
6	NPT1/8	1809 06 11	13	19.5	8	25.5	13.5	0.022
	NPT1/4	1809 06 14	13	25.5	10	25.5	13.5	0.031
	NPT3/8	1809 06 18	13	28	12	27	15	0.046
8	NPT1/2	1809 06 22	13	34	12	29	17	0.072
	NPT1/8	1809 08 11	14	22	10	28.5	14.5	0.028
	NPT1/4	1809 08 14	14	25.5	10	28.5	14.5	0.033
10	NPT1/4	1809 10 14	19	27.5	12	32.5	16	0.052
	NPT3/8	1809 10 18	19	28	12	32.5	16	0.061
	NPT1/2	1809 10 22	19	35	18	36.5	20	0.096
12	NPT1/4	1809 12 14	22	28.5	14	34	17	0.069
	NPT3/8	1809 12 18	22	29.5	14	34	17	0.074
	NPT1/2	1809 12 22	22	35	18	37	20	0.102
16	NPT3/8	1809 16 18	27	31	18	39.5	21	0.110
	NPT1/2	1809 16 22	27	34.5	18	39.5	21	0.116

1820 Stud Standpipe, Male BSPT Thread


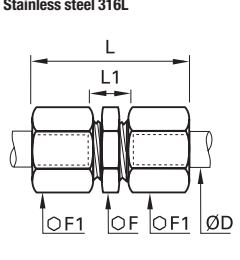

ØD	C		F	L	L1	kg
6	R1/8	1820 06 10	12	26.5	15	0.009
	R1/4	1820 06 13	14	31	15	0.017
8	R1/8	1820 08 10	12	28.5	17	0.008
	R1/4	1820 08 13	14	33	17	0.016
10	R1/4	1820 10 13	14	36	20	0.016
	R3/8	1820 10 17	17	36.5	20	0.025
12	R1/2	1820 10 21	22	41	20	0.052
	R1/4	1820 12 13	14	36	20	0.016
12	R3/8	1820 12 17	17	36.5	20	0.022
	R1/2	1820 12 21	22	41	20	0.048
16	R3/8	1820 16 17	17	39.5	23	0.022
	R1/2	1820 16 21	22	44	23	0.038

1820 Stud Standpipe, Male NPT Thread


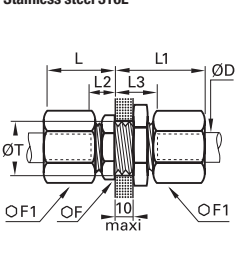

ØD	C		F	L	L1	kg
6	NPT1/8	1820 06 11	12	26.5	15	0.009
	NPT1/4	1820 06 14	14	31	15	0.019
8	NPT1/8	1820 08 11	12	28.5	17	0.009
	NPT1/4	1820 08 14	14	33	17	0.019
10	NPT1/4	1820 10 14	14	36	20	0.018
	NPT3/8	1820 10 18	19	36.5	20	0.032
12	NPT1/2	1820 10 22	22	41	20	0.060
	NPT1/4	1820 12 14	14	36	20	0.019
12	NPT3/8	1820 12 18	19	36.5	20	0.028
	NPT1/2	1820 12 22	22	41	20	0.053
16	NPT3/8	1820 16 18	19	39.5	23	0.027
	NPT1/2	1820 16 22	22	44	23	0.042

Stainless Steel Compression Fittings


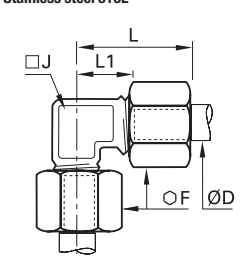

1806 Equal Tube-to-Tube Connector

	Stainless steel 316L 	ØD		F	F1	L_{max}	L1	kg
		6	1806 06 00	12	13	34.5	11	0.025
		8	1806 08 00	13	14	38.5	10	0.029
		10	1806 10 00	17	19	46	13	0.066
		12	1806 12 00	19	22	47	13	0.085
		16	1806 16 00	24	27	51	13	0.135


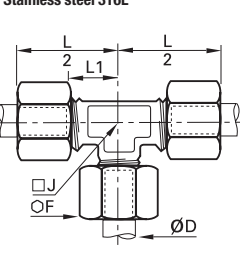

1816 Equal Bulkhead Connector

	Stainless steel 316L 	ØD		F	F1	L_{max}	L1_{max}	L2	L3	ØT_{min}	kg
		6	1816 06 00	13	13	28	19	7.5	17	10.5	0.034
		8	1816 08 00	14	14	29	20	7	17	12.5	0.042
		10	1816 10 00	19	19	33	25	9	19	16.5	0.094
		12	1816 12 00	22	22	33	25	9	19	18.5	0.113
		16	1816 16 00	27	27	36	28	9.5	19.5	22.5	0.179

1802 Equal Elbow

	Stainless steel 316L 	ØD		F	J	L_{max}	L1	kg
		6	1802 06 00	13	8	25.5	13.5	0.028
		8	1802 08 00	14	10	28.5	14.5	0.035
		10	1802 10 00	19	12	32.5	16	0.071
		12	1802 12 00	22	14	34	17	0.093
		16	1802 16 00	27	18	39.5	21	0.151

1804 Equal Tee

	Stainless steel 316L 	ØD		F	J	L1	L/2	kg
		6	1804 06 00	13	8	13.5	25.5	0.040
		8	1804 08 00	14	10	14.5	28.5	0.050
		10	1804 10 00	19	12	16	32.5	0.103
		12	1804 12 00	22	14	17	34	0.133
		16	1804 16 00	27	18	21	39.5	0.214

Stainless Steel
Compression Fittings

Compression Fittings

Complementary Stainless Steel Fittings Reducers, Olives and Nuts

This innovative reducer system, using a full range of nuts and olives, enables **different diameters** of stainless steel, fluoropolymer or polymer tubes to be fitted onto **a single Parker Legris compression fitting**.

Product Advantages

Efficient Solution

Reduces envelope dimensions
Quick and easy to assemble, whatever the diameters and tube material
Improved stock management
Silicone-free

Multiple Combinations

A single connector for up to 3 different tube materials and sizes.
Example:

- Advanced PE tubing 6 mm O.D.
- stainless steel tubing 8 mm O.D.
- fluoropolymer tubing 12 mm O.D. or braided PVC hose 10 mm I.D.

 A full range of olives and nuts to optimise all assembly operations



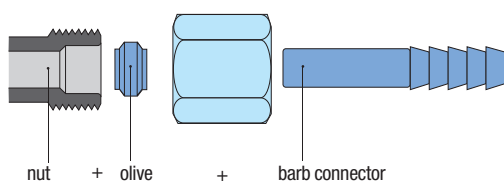
Food Process
Fluid Transmission
Pneumatics
Automotive Process
Petrochemical
Cooling & Heating
Chemical
Offshore Oil & Gas

Applications

Reducer Assembly Procedure

Operation	Assembly Sequence	Assembled Fitting
<p>1 Assemble the reducer Place the reducer in the fitting body.</p>	<p>1</p>	
<p>2 Assemble the nut and olive Place the nut and then the olive onto the tube.</p>	<p>2</p>	
<p>3 Assemble the nut Push the tube into the fitting until it bottoms on the reducer. Tighten the nut to the recommended torque (see opposite page).</p>	<p>3</p>	

Assembly: Barb Connectors




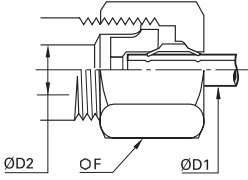

Regulations

DI: 2002/95/EC (RoHS), 2011/65/EC
DI: 97/23/EC (PED)
RG: 1935/2004
RG: 1907/2006 (REACH)
DI: 94/09/EC (ATEX)
FDA: 21 CFR 177.1550
NACE MR0175: compatible materials
ISO 15156-1/-2/-3: compatible materials


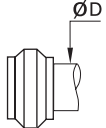

Our barb connector 1822 is designed to be also used with different types of hose. It is secured using the nut and olive provided with the fitting.

Stainless Steel Compression Fittings


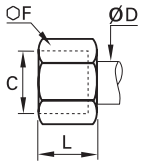

1866 3-Piece Reducer

	Stainless steel 316L 	ØD1	ØD2		F	kg
			8	1866 06 08	14	0.011
		6	10	1866 06 10	19	0.028
			12	1866 06 12	22	0.040
		8	10	1866 08 10	19	0.026
			12	1866 08 12	22	0.037
		10	16	1866 08 16	27	0.071
			12	1866 10 12	22	0.034
		12	16	1866 10 16	27	0.065
			16	1866 12 16	27	0.061


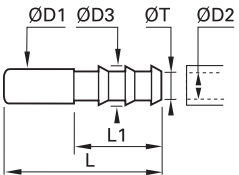

1824 Stainless Steel Olive

	Stainless steel 316L 	ØD		kg
		6	1824 06 00	0.001
		8	1824 08 00	0.001
		10	1824 10 00	0.003
		12	1824 12 00	0.004
		16	1824 16 00	0.005


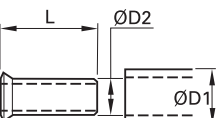

1810 Stainless Steel Nut

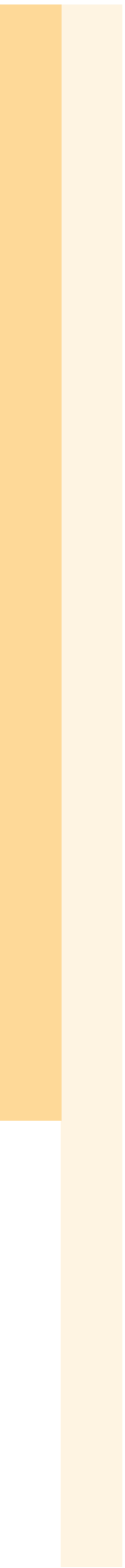
	Stainless steel 316L 	ØD	C		F	L	kg
		6	M10x1	1810 06 00	13	11	0.007
		8	M12x1	1810 08 00	14	13	0.008
		10	M16x1.5	1810 10 00	19	15	0.017
		12	M18x1.5	1810 12 00	22	15	0.024
		16	M22x1.5	1810 16 00	27	17	0.041

1822 Barb Adaptor for Hose

	Stainless steel 316L 	ØD1	ØD2		ØD3	L	L1	ØT min	kg
		6	7	1822 06 07	9	37.5	22.5	6	0.006
			6	1822 08 06	8	40	22.5	5	0.007
		8	7	1822 08 07	9	40	22.5	6	0.007
			10	1822 08 10	12.5	40	22.5	9	0.011
		10	7	1822 10 07	9	43	22.5	6	0.009
			10	1822 10 10	12.5	43	22.5	9	0.013
		12	10	1822 12 10	12.2	43	22.5	9	0.012
			13	1822 12 13	15	50	29.5	13	0.016

1827 Stainless Steel Tube Support

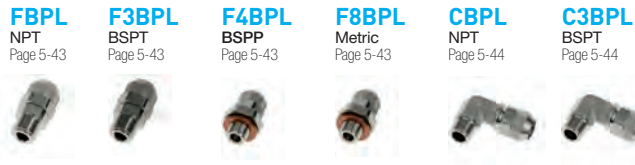
	Stainless steel 316L 	ØD1	ØD2		L	kg
		6	4	1827 06 00	11.5	0.001
		8	6	1827 08 00	14	0.001
		10	8	1827 10 00	18	0.001
		12	9	1827 12 09	18	0.001
		16	10	1827 12 00	18	0.001
This tube support is necessary when using fluoropolymer tubing at all temperatures compatible with the fitting/tubing assembly.						



PL Nickel-Plated Brass Spigot Fitting Range

PL Nickel-Plated Brass Spigot Fittings

Stud Fittings



Banjo Fitting

COR4BPL
BSP
Page 5-45



Tube-to-Tube Fittings

HBPL Connector Page 5-46	JBPL Connector Page 5-46	WBPL Bulkhead Connector Page 5-46
---------------------------------------	---------------------------------------	---



Complementary Fitting

BPLM
Nut
Page 5-46



PL Nickel-Plated Brass Spigot Fittings

This range of Parker Legris has a sealing system which guarantees **excellent sealing and full flow**. PL fittings for flexible tubing are **fully re-usable**. They provide excellent compatibility with a wide variety of fluids.

Product Advantages

Rapid Assembly

- Nut design allows hand tightening with soft tubing (PU, PE etc.)
- Quick to assemble and disassemble
- Compatible with all flexible tubes of hardness up to 90 shore A (polyurethane, polyamide, polyethylene, fluoropolymers, etc.)
- Mechanical stop on the body to prevent overtightening

Performance

- Special spigot design ensures full flow and excellent tensile performance
- Reliable direct sealing system without the use of a seal or olive
- Low and medium pressure
- Nickel-plated for increased corrosion resistance



Applications

- Food Process
- Painting
- Pneumatic Systems
- Chemical
- Welding
- Laboratories
- Railway

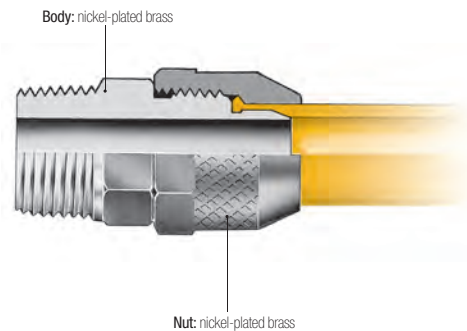
Technical Characteristics

Compatible Fluids	Compressed air Other fluids: contact us
Working Pressure	Vacuum to 40 bar
Working Temperature	-40°C to +100°C

Tensile Performance (polyamide tubing)	Ø	2.7/4	4/6	6/8	7.5/10	8/10	10/12	11/14
	daN	11	41	52	88	67	79	149

Reliable performance is dependent upon the type of fluid conveyed, component materials and tubing being used. Guaranteed for use with a vacuum of 755 mm Hg (99% vacuum).

Component Materials



Silicone-free

Installation

Cutting the Tube



Cut the polymer tube square.

Preparing the Connection



Slide the nut onto the tube.

Connecting the Tube



Push the tube home into the body of the fitting.


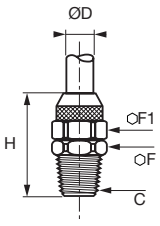

Final Assembly




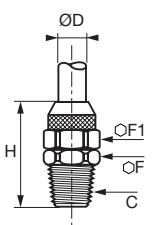

Tighten the nut by hand (in the case of soft tubing) or using a spanner (for semi-rigid tubing) until it comes into contact with the end stop.

Stud Fittings


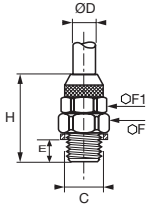

FBPL Stud Fitting, Male NPT Thread

		ØD	C		F	F1	H	kg
		2.7x4	NPT1/8	FBPL2.7/4-1/8	11	8	22	0.011
		4x6	NPT1/8	FBPL4/6-1/8	11	11	25	0.016
		4x6	NPT1/4	FBPL4/6-1/4aV	11	11	29	0.026
		6x8	NPT1/8	FBPL6/8-1/8	14	13	25	0.016
		6x8	NPT1/4	FBPL6/8-1/4	12	13	29	0.023
		8x10	NPT1/4	FBPL8/10-1/4	14	16	30	0.031
		8x10	NPT3/8	FBPL8/10-3/8	14	16	31	0.040
		10x12	NPT3/8	FBPL10/12-3/8	14	17	33	0.040

F3BPL Stud Fitting, Male BSPT Thread


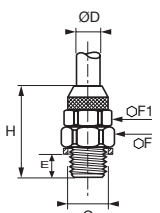

		ØD			F	F1	H	kg
		2.7x4	R1/8	F3BPL2.7/4-1/8	10	8	20.5	0.009
		4x6	R1/8	F3BPL4/6-1/8	10	11	23.5	0.016
		4x6	R1/4	F3BPL4/6-1/4	14	11	26.5	0.025
		6x8	R1/8	F3BPL6/8-1/8	12	13	23.5	0.015
		6x8	R1/4	F3BPL6/8-1/4	14	13	26.5	0.023
		6x8	R3/8	F3BPL6/8-3/8	17	13	27.6	0.026
		7.5x10	R1/4	F3BPL7.5/10-1/4	14	16	27.5	0.031
		7.5x10	R3/8	F3BPL7.5/10-3/8	17	16	28.6	0.037
		8x10	R1/4	F3BPL8/10-1/4	14	16	27.5	0.031
		8x10	R3/8	F3BPL8/10-3/8	17	16	28.6	0.043
		10x12	R3/8	F3BPL10/12-3/8	17	17	30.1	0.036
		11x14	R3/8	F3BPL11/14-3/8	19	22	32.5	0.058

F4BPL Stud Fitting, Male BSPP Thread

		ØD	C		E	F	F1	H	kg
		4x6	G1/8	F4BPL4/6-1/8	8	14	11	26	0.021
		6x8	G1/4	F4BPL6/8-1/4	9	17	13	28	0.030

These fittings are supplied with a copper seal.

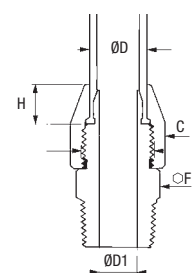
F8BPL Stud Fitting, Male Metric Straight Thread

		ØD	C		E	F	F1	H	kg
		6x8	M10x1	F8BPL6/8M10	7	14	13	28	0.021
		6x8	M12x1.25	F8BPL6/8M12	7	17	13	28	0.024

These fittings are supplied with a copper seal.

Fitting Dimensions


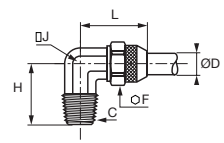

D: Tube O.D. (mm)	C: Metric Thread	D1: Bore Diameter (mm)	F: Hex (mm)	H: Tube Insertion Length (mm)
4x2.7	M6x0.75	1.5	8	4.5
6x4	M9x0.75	3	11	6.5
8x6	M11x0.75	5	13	6.5
10x7.5	M13x1	6.5	17	7
10x8	M13x1	6.5	17	7
12x10	M15x1.25	9	17	7.5
14x11	M18x1.50	9.5	22	8.5




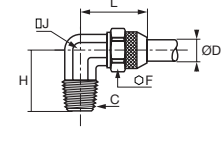

PL Nickel-Plated Brass Spigot Fittings

Stud Fittings


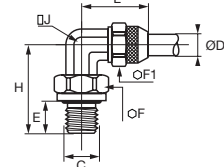

CBPL Stud Elbow, Male NPT Thread

	Nickel-plated brass		ØD	C		F	H	J	L	kg
			2.7x4	NPT1/8	CBPL2.7/4-1/8	8	18	8	22	0.019
			4x6	NPT1/8	CBPL4/6-1/8	11	18	8	24	0.023
			4x6	NPT1/4	CBPL4/6-1/4	11	23	10	25	0.036
			6x8	NPT1/8	CBPL6/8-1/8	13	19	10	25	0.027
			6x8	NPT1/4	CBPL6/8-1/4	13	23	10	25	0.034
			8x10	NPT1/4	CBPL8/10-1/4	16	24	12	28	0.058
			8x10	NPT3/8	CBPL8/10-3/8	16	25	12	28	0.059
			10x12	NPT3/8	CBPL10/12-3/8	17	27	14	32	0.051

C3BPL Stud Elbow, Male BSPT Thread


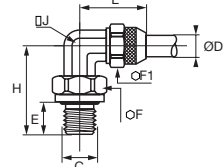

	Nickel-plated brass		ØD	C		F	H	J	L	kg
			2.7x4	R1/8	C3BPL2.7/4-1/8	8	17	8	22	0.018
			4x6	R1/8	C3BPL4/6-1/8	11	17	8	24	0.022
			4x6	R1/4	C3BPL4/6-1/4	11	21.5	10	25	0.031
			6x8	R1/8	C3BPL6/8-1/8	13	18	10	25	0.025
			6x8	R1/4	C3BPL6/8-1/4	13	21.5	10	25	0.031
			6x8	R3/8	C3BPL6/8-3/8	13	23.1	12	27	0.050
			7.5x10	R1/4	C3BPL7.5/10-1/4	16	22.5	12	28	0.057
			7.5x10	R3/8	C3BPL7.5/10-3/8	16	23.1	12	28	0.058
			8x10	R1/4	C3BPL8/10-1/4	16	21.5	12	28	0.057
			8x10	R3/8	C3BPL8/10-3/8	16	23.1	12	28	0.058
			10x12	R3/8	C3BPL10/12-3/8	17	25.1	14	32	0.052
			11x14	R3/8	C3BPL11/14-3/8	22	25.1	16	34	0.094

C4BPL Stud Elbow, Male BSPP Thread

	Nickel-plated brass, NBR		ØD	C		E	F	F1	H	J	L	kg
			6x8	G1/4	C4BPL6/8-1/4	7	13	13	27	12	27	0.063

These fittings are supplied with nitrile seals.


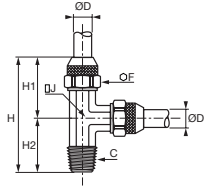

C8BPL Stud Elbow, Male Metric Straight Thread

	Nickel-plated brass, NBR		ØD	C		E	F	F1	H	J	L	kg
			6x8	M10x1	C8BPL6/8M10	7	14	13	27.25	10	21.5	0.031
			6x8	M12x1	C8BPL6/8M12	7	13	13	26	12	25	0.063


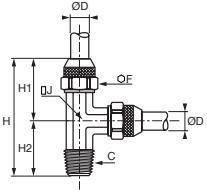

These fittings are supplied with nitrile seals.

Stud Fittings


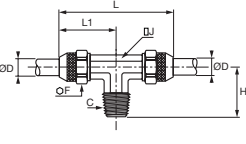

RBPL Stud Run Tee, Male NPT Thread

	Nickel-plated brass 	ØD	C		F	H	H1	H2	J	kg
		4x6	NPT1/8	RBPL4/6-1/8	11	42	24	18	8	0.037
		4x6	NPT1/4	RBPL4/6-1/4	11	48	25	23	10	0.050
		6x8	NPT1/4	RBLP6/8-1/4	13	48	25	23	10	0.046


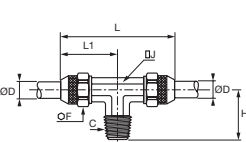

R3BPL Stud Run Tee, Male BSPT Thread

	Nickel-plated brass 	ØD	C		F	H	H1	H2	J	kg
		4x6	R1/8	R3BPL4/6-1/8	11	42	24	17	8	0.035
		4x6	R1/4	R3BPL4/6-1/4	11	48	25	21.5	10	0.048
		6x8	R1/8	R3BPL6/8-1/8	13	44	25	18	10	0.037
		6x8	R1/4	R3BLP6/8-1/4	13	48	25	21.5	10	0.045


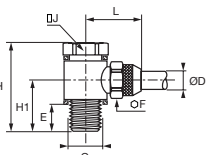

SBPL Stud Branch Tee, Male NPT Thread

	Nickel-plated brass 	ØD	C		F	H	J	L	L1	kg
		4x6	NPT1/8	SBPL4/6-1/8	11	18	8	48	24	0.035
		4x6	NPT1/4	SBPL4/6-1/4	11	23	10	50	25	0.050
		6x8	NPT1/4	SBPL6/8-1/4	13	23	10	50	25	0.049

S3BPL Branch Tee, Male BSPT Thread

	Nickel-plated brass 	ØD	C		F	H	J	L	L1	kg
		4x6	R1/8	S3BPL4/6-1/8	11	17	8	48	24	0.035
		4x6	R1/4	S3BPL4/6-1/4	11	21.5	10	50	25	0.048
		6x8	R1/8	S3BPL6/8-1/8	13	18	10	50	25	0.037
		6x8	R1/4	S3BLP6/8-1/4	13	21.5	10	50	25	0.045


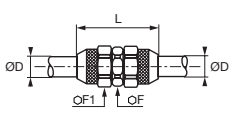

COR4BPL Single Banjo, Male BSPP Thread

	Nickel-plated brass 	ØD	C		E	F	F1	H	H1	L	kg
		4x6	G1/8	COR4BPL4/6-1/8	7	14	11	27	16	24	0.068
		4x6	G1/4	COR4BPL4/6-1/4	8	19	11	29	17	26	0.096
		6x8	G1/8	COR4BPL6/8-1/8	7	14	13	27	16	25	0.068
		6x8	G1/4	COR4BLP6/8-1/4	8	19	13	30	17	27	0.096


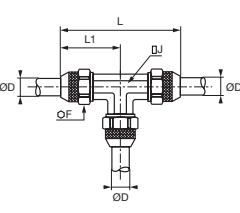

These parts are supplied with peripheral seals.
The banjo bolt is made of steel.

PL Tube-to-Tube and Complementary Fittings


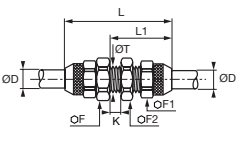

HBPL Equal Tube-to-Tube Connector

	Nickel-plated brass 	ØD		F	F1	L	kg
		2.7x4	HBPL2.7/4	7	8	24	0.010
		4x6	HBPL4/6	10	11	30	0.021
		6x8	HBPL6/8	12	13	30	0.022
		8x10	HBPL8/10	14	16	32	0.043
		10x12	HBPL10/12	16	17	36	0.056
		11x14	HBPL11/14	19	22	40	0.087


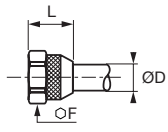

JBPL Equal Tee

	Nickel-plated brass 	ØD		F	J	L	L1	kg
		2.7x4	JBPL2.7/4	8	8	44	22	0.024
		4x6	JBPL4/6	11	8	48	24	0.042
		6x8	JBPL6/8	13	10	50	25	0.045
		7.5x10	JBPL7.5/10	16	12	56	28	0.086
		8x10	JBPL8/10	16	12	56	28	0.085
		10x12	JBPL10/12	17	14	64	32	0.100
		11x14	JBPL11/14	22	16	68	34	0.168

WBPL Equal Bulkhead Connector

	Nickel-plated brass 	ØD		F	F1	F2	K_{max}	L	L1	T_{min}	kg
		4x6	WBPL4/6	13	11	13	5	39	22	M9x0.75	0.030
		6x8	WBPL6/8	14	13	16	5	39	22	M11x0.75	0.032
		8x10	WBPL8/10	16	16	17	5	43	24	M13x1	0.057
		10x12	WBPL10/12	19	17	19	5	46	26	M15x1.25	0.064
		11x14	WBPL11/14	22	22	22	5	50	28	M18x1.5	0.112

BPLM Nut

	Nickel-plated brass 	ØD	C		F	L	kg
		2.7x4	M6x0.75	BPL4M	8	10	0.003
		4x6	M9x0.75	BPL6M	11	13	0.006
		6x8	M11x0.75	BPL8M	13	13	0.008
		7.5x10	M13x1	BPL10M	16	14	0.014
		8x10	M13x1	BPL10M	16	14	0.014
		10x12	M15x1.25	BPL12M	17	16	0.012
		11x14	M18x1.5	BPL14M	22	18	0.025

Industrial Valves

Ball Valves

LIQUIfit®

Needle and Butterfly Valves

Axial Valves



PARKER LEGRIS Industrial Connector Systems

Products are available from:

MARYLAND METRICS

P.O. Box 261 Owings Mills, MD 21117 USA email: sales@mdmetric.com

ph: (410)358-3130 (800)638-1830 fx: (410)358-3142 (800)872-9329

web: <http://mdmetric.com> RFQ form: <http://mdmetric.com/rfq.htm>

How to order: Please preface each PARKER LEGRIS Catalog part number with 'R053-' Example: R053-3175 04 10



Industrial Valves

Ball Valves, Universal Series

[P. 6-8]



Fluids: compressed air, slightly corrosive fluids

Materials: nickel-plated forged brass

Pressure: 40 bar

Temperature: -20°C to +80°C

DN : 4 mm to 40 mm

Ball Valves, Universal Series, Vented

[P. 6-13]



Fluids: compressed air, slightly corrosive fluids

Materials: nickel-plated forged brass

Pressure: 40 bar

Temperature: -20°C to +80°C

DN : 4 mm to 23 mm

Ball Valves, Universal Series, Lockable

[P. 6-15]



Fluids: compressed air, slightly corrosive fluids

Materials: nickel-plated forged brass, galvanised steel and epoxy locking system

Pressure: 40 bar

Temperature: -20°C to +80°C

DN : 4 mm to 23 mm

Ball Valves, Universal Customised Series

[P. 6-9]



Fluids: compressed air, many fluids

Materials: nickel-plated forged brass, choice of seal material (NBR, EPDM, FKM, PTFE...)

Pressure: 40 bar

Temperature: -20°C to +100°C

DN : 4 mm to 40 mm

Ball Valves, Universal Light Series

[P. 6-16]



Fluids: compressed air, slightly corrosive fluids

Materials: forged brass or nickel-plated forged brass

Pressure: 12 bar

Temperature: -20°C to +80°C

DN : 4 mm to 13 mm

Ball Valves, DVGW Series

[P. 6-20]



Fluids: compressed air, water, gas

Materials: nickel-plated forged brass

Pressure: 40 bar

Temperature: -40°C to +170°C

DN : 8 mm to 50 mm

Ball Valves, Standard Series

[P. 6-22]



Fluids: compatible fluids

Materials: nickel or chromium-plated brass with PTFE seal

Pressure: 35 bar

Temperature: -20°C to +130°C

DN : 8 mm to 100 mm

Ball Valves, Stainless Steel Series

[P. 6-28]



Fluids: all fluids

Materials: 316L stainless steel

Pressure: 65 bar

Temperature: -20°C to +150°C

DN : 8 mm to 50 mm

Ball Valves, Stainless Steel Light Series

[P. 6-28]



Fluids: all fluids

Materials: 316L stainless steel

Pressure: 65 bar

Temperature: -20°C to +120°C

DN : 4 mm to 10 mm

Industrial Valves

Ball Valves, High Pressure Series

[P. 6-30]



Fluids: lubricants, gases
Materials: zinc-plated brass
Pressure: 300 bar
Temperature: -15°C to +80°C
 $\overline{\text{DN}}$: 7 mm to 13 mm

Ball Valves, Mini Series

[P. 6-32]



Fluids: compressed air
Materials: technical polymer
Pressure: 10 bar
Temperature: -20°C to +80°C
 $\overline{\text{DN}}$: 4 mm to 12 mm

Ball Valves, LIQUIfit®

[P. 6-34]



Fluids: water, beverages, CO₂, inert gases
Materials: polypropylene, EPDM seal
Pressure: 10 bar
Temperature: -15°C to +100°C
Tube Ø: 1/4" and 3/8"

Needle Valves, Brass

[P. 6-37]



Fluids: compressed air, industrial fluids
Materials: shot-blasted forged brass, nickel-plated
Pressure: 120 bar
Temperature: -20°C to +100°C
 $\overline{\text{DN}}$: 4 mm to 10 mm

Needle Valves, Stainless Steel

[P. 6-41]



Fluids: all fluids
Materials: 316L stainless steel
Pressure: 400 bar
Temperature: -20°C to +180°C
 $\overline{\text{DN}}$: 3 mm to 6 mm

Butterfly Valves

[P. 6-42]



Fluids: compressed air, abrasive fluids
Materials: shot-blasted forged brass, nickel-plated
Pressure: 16 bar
Temperature: -20°C to +80°C
 $\overline{\text{DN}}$: 6 mm to 18 mm

Axial Valves

[P. 6-45]



Fluids: compressed air, industrial fluids
Materials: nickel-plated brass
Pressure: 10 bar
Temperature: -20°C to +135°C
Threads : 3/8" to 2"

Ball Valve Range

Universal and Universal Customised Series

In-Line

0402 2/2 Page 6-10
0401 2/2 Page 6-10
0400 2/2 Page 6-10
0411 2/2 Page 6-10
0414 2/2 Page 6-10



In-Line with Fixing Holes and Panel Mounting

0446 2/2 Page 6-11
6402 2/2 Page 6-11
6401 2/2 Page 6-11



Right-Angled

0472 2/2 Page 6-11
0471 2/2 Page 6-11



In-Line, 3-Way

0482 3/3 Page 6-12
0483 3/3 Page 6-12



In-Line, 3-Way with Fixing Holes and Panel Mounting

0448 3/3 Page 6-12
0452 3/2 Page 6-12



Universal Series, Vented

In-Line

0489 3/2 Page 6-13
0449 3/2 Page 6-13
0469 3/2 Page 6-13



Right-Angled

0462 3/2 Page 6-14
0461 3/2 Page 6-14



Universal Lockable Series

In-Line

0432 2/2 Page 6-15



In-Line, Vented

0439 3/2 Page 6-15
0436 3/2 Page 6-15
0437 3/2 Page 6-15



In-Line, 3-Way

0438 3/2 Page 6-15



Universal Light Series

In-Line

0492 2/2 Page 6-17
0491 2/2 Page 6-17
0490 2/2 Page 6-17



In-Line, Vented

0494 2/2 Page 6-18



In-Line with Square Stem

0497 2/2 Page 6-18
0496 2/2 Page 6-18



Ball Valve Range

DVGW Series

In-Line

BVG4-L

2/2
Page 6-21



BVGT4-L

2/2
Page 6-21



Standard Series

In-Line

4902

2/2
Page 6-23



BVGT4-C

2/2
Page 6-23



Compact

4991

2/2
Page 6-23



4992

2/2
Page 6-23



In-Line, Lockable

BVG4-LOCK

2/2
Page 6-24



In-Line, Lockable, Vented

BVG4P-LOCK

3/2
Page 6-24



Stainless Steel Series

In-Line

4832

Mountable and dismountable
2/2
Page 6-29



4812

Mountable
2/2
Page 6-29



4810

One-Piece Construction
2/2
Page 6-29



0465

Light Series
2/2
Page 6-29



High Pressure Series

In-Line

4402

2/2
Page 6-31



Mini Series

In-Line

7910

2/2
Page 6-33



7911

2/2
Page 6-33



In-Line, Vented and Accessories

7913

3/2
Page 6-33



7914

3/2
Page 6-33



7000

Page 6-33



LIQUIFIT®

In-Line

4020

2/2
Page 6-35



4021

2/2
Page 6-35



4023

2/2
Page 6-35



Right-Angled

4022

2/2
Page 6-35



Accessories

3130

Page 6-35



Ball Valves, Universal Series

This range of valves has patented **seal wear compensating** technology for **reliable** and **durable** sealing, **protecting** any system whether under pressure or **vacuum**.

Product Advantages

Durability & Reliability

- Automatic seal wear compensation for long-term reliability
- Robust, corrosion-resistant materials
- 100% leak-tested in production
- Date coding to guarantee quality and traceability

Versatility & Performance

- Ideal for ensuring the performance of pneumatic circuits
- Customised valves for all special applications
- Unequalled performance under vacuum
- Smooth operation thanks to self-lubricating seals
- Large range of working pressures and temperatures
- Lever can be repositioned and replaced
- Many configurations to satisfy all system requirements



Applications

- Pneumatics
- Vacuum
- Transportation
- Packaging
- Textile
- Sawmill
- Rubber & Plastics

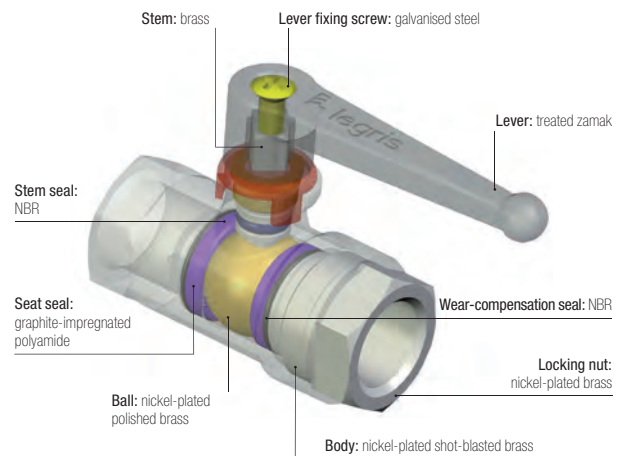
Technical Characteristics

Compatible Fluids	Industrial fluids						
Working Pressure	Vacuum to 40 bar						
Working Temperature	-20°C to + 80°C						

Tightening Torques	Threads	G1/8	G1/4	G3/8	G1/2	G3/4	G1	
	daN.m	0.10 to 0.20	0.10 to 0.20	0.15 to 0.25	0.20 to 0.35	0.50 to 0.70	0.50 to 0.70	
	Threads	G1¼	G1½	G2				
	daN.m	0.40 to 0.60	0.80 to 1.20	0.80 to 1.20				

Reliable performance is dependent upon the type of fluid conveyed, component materials and tubing being used.
Guaranteed for use with a vacuum of 755 mm Hg (99 % vacuum).

Component Materials



Silicone-free

Regulations

- DI: 97/23/EC (module PED A - diameters greater than 25 mm)
- DI: 2006/42/EC (Machinery Directive)
- DI: 2002/95/EC (RoHS)
- RG: 1907/2006 (REACH)

Universal Series

Installation Options

Lockable Valves

Our lockable ball valves have been developed in order to prevent potentially dangerous consequences caused by unintended operation. Lockable in different positions, this range meets international safety requirements, such as ISO 4414.

The valves are lockable:

- at one point: models 0432 and 0439
- at three points: models 0437 and 0438

Vented Valves

To stop fluid circulation and vent the circuit, 2 venting systems are provided:

- with threaded exhaust, to allow discharge of downstream media
- with pin-hole vent, for applications with no special discharge requirement

Fluid flow direction is indicated by an arrow on the valve body.

Mountable Valves

On steel plate:

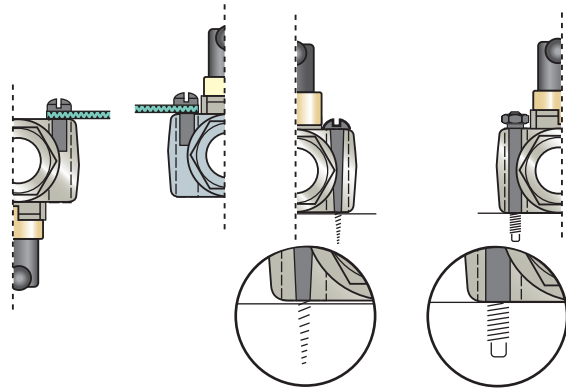
- bulkhead fixing
- complete valve below bulkhead

On frame:

- assemble with bolts

On wooden panel:

- assemble with woodscrews



Universal Customised Valve Series

Based on the standard components of the universal series, this range allows the valve to be adapted to specific needs. There are 6 product versions available on request.

Product Codes

Valve type	0402 04 10 22		Suffix
0400	DN	Thread	20 = blue/red
0401			22 = green/blue
0402	04 = 4 mm	10 = 1/8"	26 = yellow/yellow
...	05 = 5 mm	13 = 1/4"	27 = blue/green
	30 = white/red
	40 = 40 mm	48 = 2"	32 = white/green

Identification

Each series may be easily identified by a colour marking on the lever.



Suffix Specification

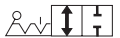
Identification		Body		Lever			Ball		Stem and Wear-Compensation Seals			Seat Seals			Application Examples
Suffix on the body	Colour bands on the lever	Nickel-plated brass	Chemical nickel-plated brass	Standard	Nickel-plated brass	Chemical nickel-plated brass	Nickel-plated polished brass	Chemical nickel-plated brass	EPDM	FKM	PTFE white	Rilsan: graphite-impregnated	Filled PTFE	PTFE white	
20	Blue/Red	•		•			•			•		•			Hydrocarbons
22	Green/Blue	•		•				•		•			•		Industrial fluids and high temperature
26*	Yellow/Yellow	•			•			•			•	olive		•	Corrosive liquids or high temperature
27	Blue/Green		•			•		•		•			•		Industrial fluids and/or harsh environments
30**	White/Red	•		•			•		•			•			Gaseous oxygen circuits
32	White/Green	•		•			•		•				•		Water and steam circuits

*degreased **oxygen-compatible grease

A usage chart in this chapter shows which type of valve to use according to the fluid being conveyed.

Universal and Universal Customised Series

0402 2/2 In-Line Ball Valve, Female BSPP Thread



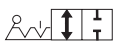
	Nickel-plated brass, NBR 	C	DN		E	F	F1	H	H1	L	L1	M	kg
		G1/8	4	0402 04 10	8	-	14	35	29	44	25	48	0.094
			7	0402 07 10	8	19	19	38	31	51	27	48	0.166
		G1/4	7	0402 07 13	12	19	19	38	31	53	28	48	0.156
		G3/8	10	0402 10 17	12	24	24	45	43	59	31	69	0.244
		G1/2	13	0402 13 21	15	27	27	47	44	67	34	69	0.292
		G3/4	20	0402 20 27	16.5	32	38	63	54	80	39	108	0.655
		G1	23	0402 23 34	19	41	46	67	57	94	47	108	1.036
		G1¼	32	0402 32 42*	21.5	55	60	97	115	112	59	180	2.467
		G1½	40	0402 40 49*	22	55	60	97	115	120	62	180	2.340
G2	40	0402 40 48*	26	70	70	104	-	122	61	190	2.614		
*Models with CE marking Maximum working pressure: 40 bar													

0401 2/2 In-Line Ball Valve, Male/Female BSPP Thread



	Nickel-plated brass, NBR 	C	DN		E	E1	F	H	H1	J	L	L1	M	kg
		G1/8	4	0401 04 10	8	7	14	35	29	14	45	25	48	0.094
			5	0401 05 10	8	7	19	38	31	19	51	27	48	0.160
		G1/4	7	0401 07 13	12	9	19	38	31	19	52	28	48	0.150
		G3/8	10	0401 10 17	12	11	24	45	43	24	58	31	69	0.234
		G1/2	13	0401 13 21	15	12	27	47	44	27	66	34	69	0.286
		G3/4	18	0401 18 27	16.5	12	38	63	54	39	79	39	108	0.652
		G1	23	0401 23 34	19	15	46	67	57	48	91	47	108	0.952
		G1¼	32	0401 32 42*	21.5	18	60	97	115	55	113	59	108	2.385
		*Models with CE marking Maximum working pressure: 40 bar												

0400 2/2 In-Line Ball Valve, Male BSPP Thread



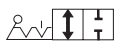
	Nickel-plated brass, NBR 	C	DN		E	F	H	H1	J	L	L1	M	kg
		G1/8	4	0400 04 10	7	14	35	29	14	45	25	48	0.094
		G1/4	7	0400 07 13	9	19	38	31	19	60	36	48	0.166
		G3/8	10	0400 10 17	11	24	45	43	24	70	43	69	0.252
		G1/2	13	0400 13 21	12	27	47	44	27	78	45	69	0.324
		G3/4	18	0400 18 27	12	38	63	54	39	90	50	108	0.714
Maximum working pressure: 40 bar													

0411 2/2 In-Line Ball Valve with Connections for Use with Steel Tube



	Nickel-plated brass, NBR 	ØD	DN		F	F1	H	H1	J	L	L1	M	kg
		6	4	0411 04 06	14	19	38	31	19	76	30	48	0.073
		8	6	0411 06 08	17	19	38	31	19	77	30	48	0.095
		10	7	0411 07 10	19	19	38	31	19	78	31	48	0.100
		12	10	0411 10 12	22	24	45	43	24	85	36	69	0.110
Maximum working pressure: 40 bar													

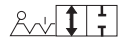
0414 2/2 In-Line Ball Valve with Compression Connections


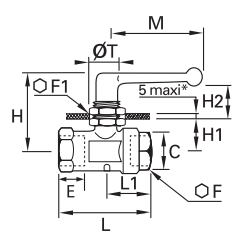



	Nickel-plated brass, NBR 	ØD	DN		F	F1	H	H1	J	L	L1	M	kg
		6	4	0414 04 06	13	19	38	31	19	72	31	48	0.177
		8	6	0414 06 08	14	19	38	31	19	74	30	48	0.180
		10	7	0414 07 10	19	19	38	31	19	78	31	48	0.210
		12	10	0414 10 12	22	24	45	43	24	86	36	69	0.308
Maximum working pressure: 40 bar													

Universal and Universal Customised Series

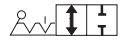
0446 2/2 In-Line Panel-Mountable Ball Valve, Female BSPP Thread


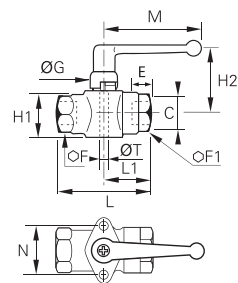



	Nickel-plated brass, NBR 	C	DN		E	F	F1	H	H1	H2	L	L1	M	ØT	kg
		G1/8	4	0446 04 10	8	14	22	37	14	12	44	25	48	16.5	0.112
		G1/4	7	0446 07 13	12	19	24	45	19	14	53	28	48	20.5	0.188
		G3/8	10	0446 10 17	12	24	27	50	21	21	59	31	69	20.5	0.294
		G1/2	13	0446 13 21	15	27	27	51	23	21	67	34	69	20.5	0.338

Maximum working pressure: 20 bar
*For G1/8 version, maximum panel thickness = 3 mm

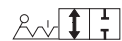
6402 2/2 In-Line Ball Valve for Screw Fixing, Female BSPP Thread


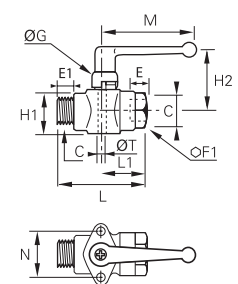



	Nickel-plated brass, NBR 	C	DN		E	F	F1	G	H1	H2	L	L1	M	N	ØT	kg
		G1/8	4	6402 04 10	8	14	14	18	18	30	44	25	48	25	4x70	0.132
		G1/4	7	6402 07 13	12	19	19	19	24	31	53	28	48	31	5x80	0.216
		G3/8	10	6402 10 17	12	24	24	20	30	45	59	31	69	31	5x80	0.324
		G1/2	13	6402 13 21	15	27	27	20	34	47	67	34	69	34	6x100	0.404
		G3/4	20	6402 20 27	16.5	32	38	27	44	52	80	39	108	43	8x125	0.830

Maximum working pressure: 40 bar

6401 2/2 In-Line Ball Valve for Screw Fixing, Male/Female BSPP Thread


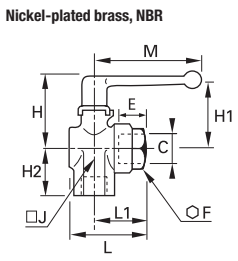



	Nickel-plated brass, NBR 	C	DN		E	E1	F	G	H1	H2	L	L1	M	N	ØT	kg
		G1/8	4	6401 04 10	8	7	14	18	18	30	45	25	48	25	4x70	0.127
		G1/4	7	6401 07 13	12	9	19	19	24	31	52	28	48	31	5x80	0.212
		G3/8	10	6401 10 17	12	11	24	20	30	45	58	31	69	31	5x80	0.306
		G1/2	13	6401 13 21	15	12	27	20	34	47	67	34	69	34	6x100	0.394

Maximum working pressure: 40 bar

0472 2/2 Right-Angled Ball Valve, Female BSPP Thread


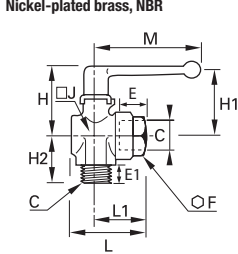



	Nickel-plated brass, NBR 	C	DN		E	F	H	H1	H2	J	L	L1	M	kg
		G1/8	4	0472 04 10	8	14	35	29	18	14	34	25	48	0.096
			6	0472 06 10	8	19	38	31	20	22	37	27	48	0.183
		G1/4	6	0472 06 13	12	19	38	31	24	22	38	28	48	0.191
		G3/8	9	0472 09 17	12	24	45	43	27	25	46	31	69	0.260
		G1/2	12	0472 12 21	15	27	47	44	33	29	49	34	69	0.312
		G3/4	18	0472 18 27	16.5	38	59	51	40	39	60	39	108	0.704
		G1	23	0472 23 34	19	46	63	55	47	48	72	47	108	1.062

Maximum working pressure: 20 bar

0471 2/2 Right-Angled Ball Valve, Male/Female BSPP Thread



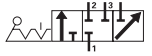
	Nickel-plated brass, NBR 	C	DN		E	E1	F	H	H1	H2	J	L	L1	M	kg
		G1/8	4	0471 04 10	8	7	14	35	29	19	14	34	25	48	0.096
			6	0471 06 10	8	7	19	38	31	22	22	37	27	48	0.182
		G1/4	6	0471 06 13	12	9	19	38	31	25	22	38	28	48	0.187
		G3/8	9	0471 09 17	12	11	24	45	43	28	25	46	31	69	0.256
		G1/2	12	0471 12 21	15	12	27	47	44	32	29	49	34	69	0.300
		G3/4	18	0471 18 27	16.5	12	38	59	51	37	39	60	39	108	0.682
		G1	23	0471 23 34	19	15	46	63	55	44	48	72	47	108	1.020

Maximum working pressure: 20 bar

Ball Valves
Industrial Valves

Universal and Universal Customised Series

0482 3/3 Right-Angle Ported Ball Valve, Female BSPP Thread



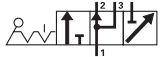
Nickel-plated brass, NBR

	C	DN		E	F	H	H1	H2	J	L	L1	M	kg
G1/8	4		0482 04 10	8	14	35	29	18	14	44	25	48	0.103
G1/4	6		0482 06 13	12	19	38	31	24	22	53	28	48	0.200
G3/8	9		0482 09 17	12	24	45	43	27	25	59	31	69	0.284
G1/2	12		0482 12 21	15	27	47	44	33	29	67	34	69	0.346
G3/4	18		0482 18 27	16.5	38	59	51	40	39	80	39	108	0.742
G1	23		0482 23 34	19	46	63	55	47	48	94	47	108	1.160

Maximum working pressure: 20 bar

Closed

0483 3/3 Right-Angle Ported Ball Valve without Closed Position, Female BSPP Thread

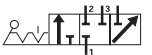


Nickel-plated brass, NBR

	C	DN		E	F	H	H1	H2	J	L	L1	M	kg
G1/8	4		0483 04 10	8	14	35	29	18	14	44	25	48	0.102
G1/4	6		0483 06 13	12	19	38	31	24	22	53	28	48	0.196
G3/8	9		0483 09 17	12	24	45	43	27	25	59	31	69	0.278
G1/2	12		0483 12 21	15	27	47	44	33	29	67	34	69	0.340
G3/4	18		0483 18 27	16.5	38	59	51	40	39	80	39	108	0.716
G1	23		0483 23 34	19	46	63	55	47	48	94	47	108	1.066

Maximum working pressure: 20 bar

0448 3/2 Panel-Mountable Right-Angled Ball Valve, Female BSPP Thread



Nickel-plated brass, NBR

	C	DN		E	F	F1	H	H1	H2	H3	J	L	L1	M	ØT	kg
G1/8	4		0448 04 10	8	14	22	37	14	18	12	14	44	25	48	16.5	0.126
G1/4	6		0448 06 13	12	19	24	45	19	24	14	22	53	28	48	20.5	0.230
G3/8	9		0448 09 17	12	24	27	50	21	27	21	25	59	31	69	20.5	0.328
G1/2	12		0448 12 21	15	27	27	51	23	33	21	29	67	34	69	20.5	0.392

Maximum working pressure: 20 bar
*For G1/8 version: maximum panel thickness = 3 mm

Closed

0452 3/2 Panel-Mountable Equal Plane Ball Valve, Female BSPP Thread



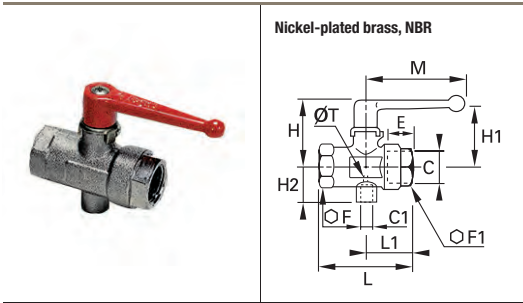
Nickel-plated brass, NBR

	C	DN		E	F	F1	H	H1	H2	J	K	L	ØT	kg
G1/8	4		0452 04 10	8	14	22	39	10	8	16	18	25	19	0.130
G1/4	6		0452 06 13	12	19	24	40	11	11	23	24	28	20	0.206

Maximum working pressure: 20 bar

Universal Series, Vented

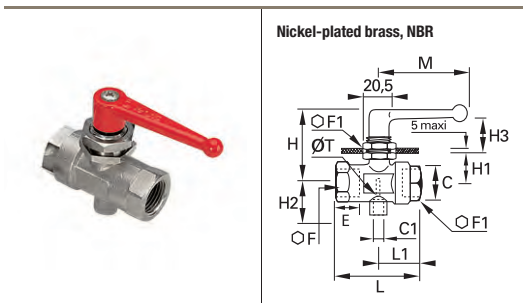
0489 3/2 In-Line Vented Ball Valve, Female BSPP and Metric Thread



C	C1	DN		E	F	F1	H	H1	H2	L	L1	M	ØT	kg
G1/4	M5x0.8	7	0489 07 13	12	24	24	46	43	17	59	31	69	2	0.270
G3/8	M5x0.8	10	0489 10 17	12	24	24	46	43	17	59	31	69	2	0.243
G1/2	G1/8	13	0489 13 21	15	27	27	47	44	24	67	34	69	2	0.310
G3/4	G1/4	18	0489 18 27	16.5	32	38	63	54	33	80	39	108	2.5	0.670
G1	G1/4	23	0489 23 34	19	41	46	67	57	37	94	47	108	3	1.050

Maximum working pressure: 40 bar

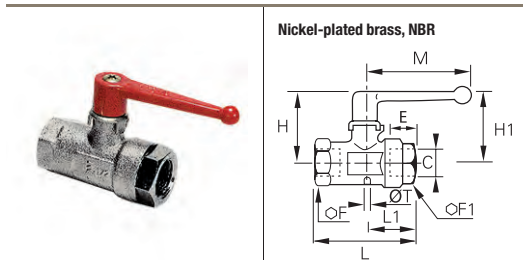
0449 3/2 Panel-Mountable In-Line Ball Valve, Female BSPP and Metric Thread



C	C1	DN		E	F	F1	H	H1	H2	H3	L	L1	M	ØT	kg
G1/4	M5x0.8	7	0449 07 13	12	24	27	50	20	17	21	59	31	69	2.5	0.313
G3/8	M5x0.8	10	0449 10 17	12	24	27	50	20	17	21	59	31	69	2.5	0.291
G1/2	G1/8	13	0449 13 21	15	27	27	52	23	24	21	67	34	69	4	0.352

Maximum working pressure: 20 bar

0469 3/2 In-Line Vented Ball Valve, Female BSPP Thread



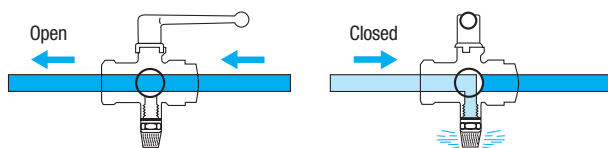
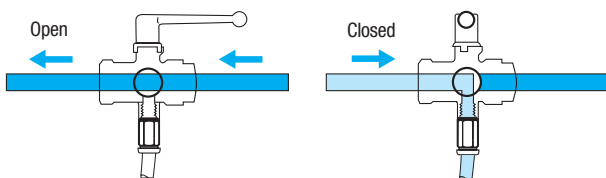
C	DN		E	F	F1	H	H1	L	L1	M	ØT	kg
G1/8	4	0469 04 10	8	14	14	35	29	44	25	48	1.5	0.092
G1/4	7	0469 07 13	12	24	24	46	43	59	31	70	2	0.268
G3/8	10	0469 10 17	12	24	24	46	43	59	31	70	2	0.246
G1/2	13	0469 13 21	15	27	27	47	44	67	34	70	2	0.294
G3/4	18	0469 18 27	16.5	32	38	63	54	80	39	108	2.5	0.668
G1	23	0469 23 34	19	41	46	67	57	94	47	108	3	1.026

Maximum working pressure: 40 bar

Operation of Vented Ball Valves

With vent connected to a tube = collection of purged media

With vent connected to a silencer = noiseless discharge to atmosphere


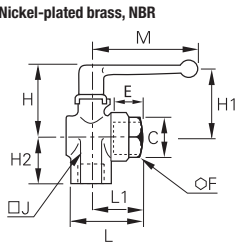




You will find our ranges of fittings, tubing and silencers in Chapters 1, 3 and 9.

Universal Series, Vented

0462 3/2 Right-Angled Ball Valve with Vent, Female BSPP Thread


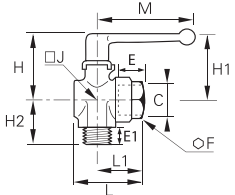




	Nickel-plated brass, NBR					C	DN	E	F	H	H1	H2	J	L	L1	M	kg											
	G1/8	6																0462 06 10	8	19	38	31	20	22	37	27	48	0.192
	G1/4	6																0462 06 13	12	19	38	31	24	22	38	28	48	0.185
	G3/8	9																0462 09 17	12	24	45	43	27	25	46	31	69	0.261
	G1/2	12																0462 12 21	15	27	47	44	33	29	49	34	69	0.312
	G3/4	18																0462 18 27	16.5	38	59	51	40	39	60	39	108	0.698
G1	23	0462 23 34	19	46	63	55	47	48	72	47	108	1.066																

Maximum working pressure: 20 bar

0461 3/2 Right-Angled Ball Valve with Vent, Male/Female BSPP Thread



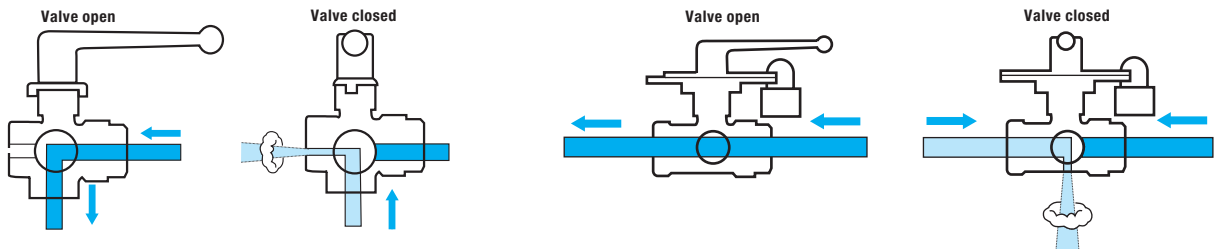
	Nickel-plated brass, NBR					C	DN	E	E1	F	H	H1	H2	J	L	L1	M	kg												
	G1/8	6																	0461 06 10	8	7	19	38	31	20	22	37	27	48	0.182
	G1/4	6																	0461 06 13	12	9	19	38	31	24	22	38	28	48	0.186
	G3/8	9																	0461 09 17	12	11	24	45	43	27	25	46	31	69	0.257
	G1/2	12																	0461 12 21	15	12	27	47	44	33	29	49	34	69	0.304
	G3/4	18																	0461 18 27	16.5	12	38	59	51	40	39	60	39	108	0.648

Maximum working pressure: 20 bar

Operation of Right-Angled Vented Ball Valves

Operation of Lockable Vented Ball Valves

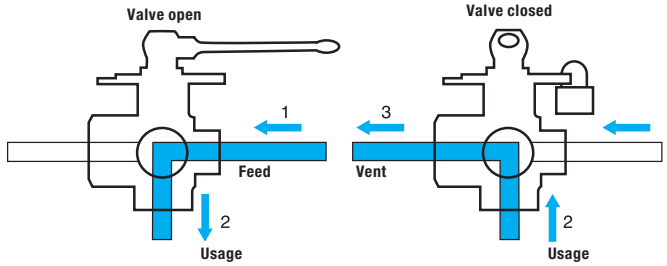
With pin-hole vent = purge to atmosphere without silencer



Removable lever: where the lever is obstructed in its movement, it can be refitted the opposite way.

Operation of 3/2 Lockable Valves

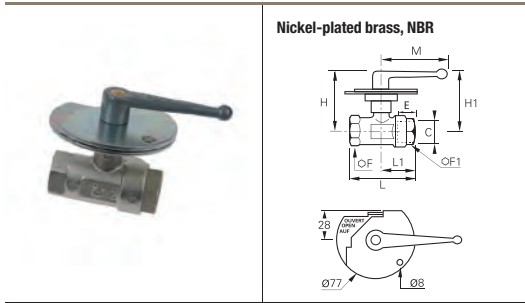
Drilled below and square in the horizontal plane, these valves provide a connection between: either port 1 and port 2, or port 2 and port 3.



Removable lever: where the lever is obstructed in its movement, it can be refitted the opposite way.

Universal Series, Lockable

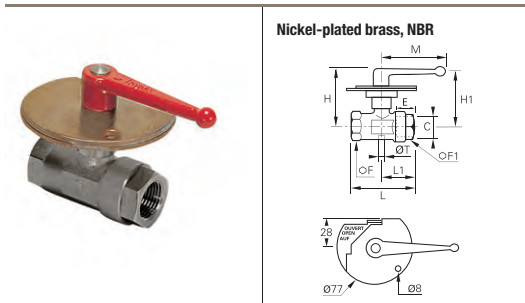
0432 2/2 In-Line Lockable Ball Valve, Female BSPP Thread



C	DN		E	F	F1	H	H1	L	L1	M	kg
G1/8	4	0432 04 10	8	19	19	59	54	51	27	69	0.415
G1/4	7	0432 07 13	12	19	19	59	54	59	28	69	0.396
G3/8	10	0432 10 17	12	24	24	60	55	59	31	69	0.460
G1/2	13	0432 13 21	15	27	27	62	57	67	34	69	0.522
G3/4	20	0432 20 27	16.5	32	38	66	56	80	39	108	0.800
G1	23	0432 23 34	19	41	46	70	59	94	47	108	1.186

Maximum working pressure: 40 bar
 Handle is not removable.
 Fixed and mobile plates: zinc-plated steel.

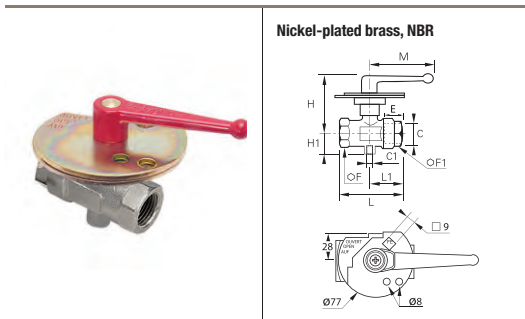
0439 3/2 In-line Vented Lockable Ball Valve, Female BSPP Thread



C	DN		E	F	F1	H	H1	L	L1	M	ØT	kg
G1/8	4	0439 04 10	8	19	19	59	54	51	27	69	2	0.410
G1/4	7	0439 07 13	12	19	24	60	55	59	31	69	2	0.480
G3/8	10	0439 10 17	12	24	24	60	55	59	31	69	2	0.460
G1/2	13	0439 13 21	15	27	27	62	57	67	34	69	2	0.514
G3/4	18	0439 18 27	16.5	32	38	66	56	80	39	108	2.5	0.810
G1	23	0439 23 34	19	41	46	70	59	94	47	108	3	1.185

Maximum working pressure: 40 bar
 Handle is not removable.
 Fixed and mobile plates: zinc-plated steel.

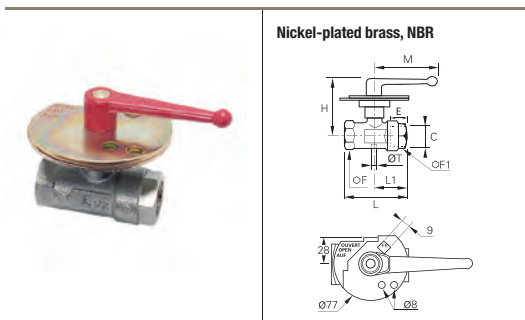
0436 3/2 In-Line Lockable Ball Valve with Threaded Exhaust Port, Female BSPP and Metric Thread



C	C1	DN		E	F	F1	H	H1	L	L1	M	kg
G3/8	M5x0.8	10	0436 10 17	12	24	24	60	17	60	32	69	0.475
G1/2	G1/8	13	0436 13 21	15	27	27	60	24.5	67.5	34.5	69	0.500
G3/4	G1/4	18	0436 18 27	16.5	32	38	69.5	33	80	39.5	108	0.850
G1	G1/4	23	0436 23 34	19	32	38	69.5	33	80	39.5	108	1.215

Maximum working pressure: 40 bar
 Handle is not removable.
 Fixed and mobile plates: zinc-plated steel.

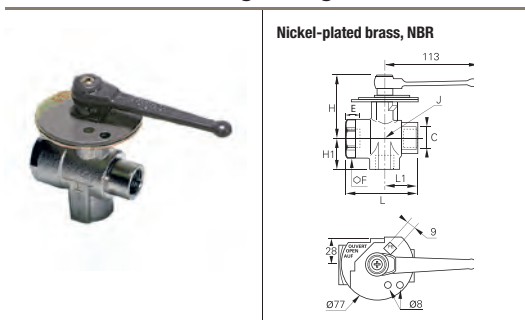
0437 3/2 In-line Vented 3-Point Lockable Ball Valve, Female BSPP Thread



C	DN		E	F	F1	H	L	L1	M	ØT	kg
G1/4	7	0437 07 13	12	24	24	60	59	32	69.5	2	0.476
G3/8	10	0437 10 17	12	24	24	60	60	32	69.5	2	0.456
G1/2	13	0437 13 21	15	27	27	60	67.5	34.5	69.5	2	0.510
G3/4	18	0437 18 27	16.5	32	38	69.5	80	39.5	108.5	2.5	0.820
G1	23	0437 23 34	19	41	46	73	94.5	47.5	108.5	3	1.192

Maximum working pressure: 40 bar
 Handle is not removable.
 Fixed and mobile plates: zinc-plated steel.

0438 3/2 Right-Angled 3-Point Lockable Ball Valve, Female BSPP Thread



C	DN		E	F	H	H1	J	L	L1	kg
G3/8	9	0438 09 17	12	38	76	34	39	73	35	0.970
G1/2	12	0438 12 21	15	38	76	37	39	78	38	0.947
G3/4	18	0438 18 27	16.5	38	76	40	39	80	40	0.905
G1	23	0438 23 34	19	46	80	47	48	94	47	1.295

Maximum working pressure: 20 bar
 Fixed plate: zinc-plated steel, mobile plate: steel, grey epoxy-coated.
 Removable handle: where the handle is obstructed in its movement, it can be refitted opposite the original position.

Ball Valves
 Industrial Valves

Ball Valves, Universal Light Series

Using the Universal Series technology, the Parker Legris light series valves offer the advantages of **compactness**, **ease of operation** and **long-term reliability**.

Product Advantages

- Easy-to-Use**
 - Ease of operation due to the low friction design
 - The short levers may be repositioned and exchanged
 - Extremely compact
 - Wide range of configurations
- Maximum Efficiency**
 - Excellent performance under vacuum
 - Full flow
 - Chemical nickel-plated brass with high phosphorous content for outstanding corrosion resistance
 - Automatic seal wear compensation system
- Reliability**
 - Tried-and-tested technology
 - Forged brass provides mechanical strength and long service life
 - 100% leak-tested in production
 - Date coding to guarantee quality and traceability



- Applications**
- Vacuum
 - Transportation
 - Packaging
 - Textile
 - Pneumatics
 - Sawmills
 - Rubber & Plastics

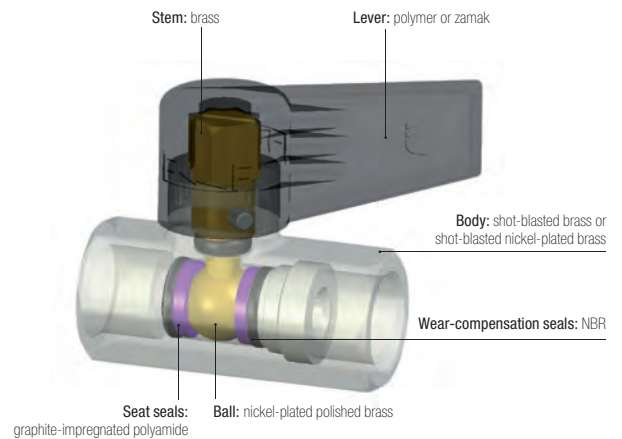
Technical Characteristics

Compatible Fluids	Compressed air Other fluids: see compatibility chart at the end of this chapter
Working Pressure	Vacuum to 12 bar
Working Temperature	-20°C to +80°C

Tightening Torques	Threads	G1/8	G1/4	G3/8	G1/2	G3/4
	daN.m	0.10 to 0.20	0.10 to 0.20	0.15 to 0.25	0.20 to 0.35	0.50 to 0.70

Reliable performance is dependent upon the type of fluid conveyed, component materials and tubing being used.
Guaranteed for use with a vacuum of 755 mm Hg (99% vacuum).

Component Materials



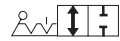
Silicone-free

Regulations

- DI: 97/23/EC (module PED A - diameters greater than 25 mm)
- DI: 2006/42/EC (Machinery Directive)
- DI: 2002/95/EC (RoHS)
- RG: 1907/2006 (REACH)

Universal Light Series

0492 2/2 In-Line Ball Valve, Female BSPP Thread



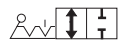
	Nickel-plated brass, NBR 	C DN	E	F	H	L	L1	M	kg		
		G1/4	4	0492 04 13	9	17	34	39.5	17	35	0.073
		G3/8	7	0492 07 17	11	22	38	45	20	43	0.128
		G1/2	10	0492 10 21	12	24	44	54	25	50	0.162
		G3/4	13	0492 13 27	14	30	46	62	28	50	0.240
Technical polymer handle											

0492..64 2/2 In-Line Ball Valve, Short Handle, Female BSPP Thread



	Nickel-plated brass, NBR 	C DN	E	F	H	L	L1	M	kg		
		G1/4	4	0492 04 13 64	9	17	36	39.5	17	25	0.090
		Short handle in zamak									

0491 2/2 In-Line Ball Valve, Male/Female BSPP Thread



	Nickel-plated brass, NBR 	C DN	E	E1	F	H	L	L1	M	kg		
		G1/4	4	0491 04 13	9	7	17	34	39.5	17	35	0.070
		G3/8	7	0491 07 17	11	8	22	38	45	20	43	0.124
		G1/2	10	0491 10 21	12	10	24	44	53	24	50	0.160
		G3/4	13	0491 13 27	14	12	30	46	59	25	50	0.238
Technical polymer handle												

0491..64 2/2 In-Line Ball Valve, Short Handle, Male/Female BSPP Thread



	Nickel-plated brass, NBR 	C DN	E	E1	F	H	L	L1	M	kg		
		G1/4	4	0491 04 13 64	9	7	17	36	39.5	17	25	0.092
		Short handle in zamak										

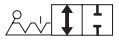
0490 2/2 In-Line Ball Valve, Male BSPP Thread


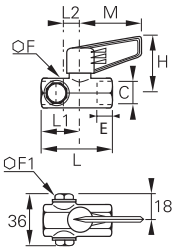




	Nickel-plated brass, NBR 	C DN	E	F	H	L	L1	M	kg		
		G1/4	4	0490 04 13	7	17	34	39	17	35	0.070
		G3/8	7	0490 07 17	8	22	38	44	20	43	0.109
		G1/2	10	0490 10 21	10	24	44	53	24	50	0.160
		G3/4	13	0490 13 27	12	30	46	59	25	50	0.233
Technical polymer handle											

Universal Light Series


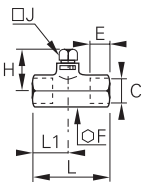


0494 2/2 In-Line Ball Valve, 2 Vent Plugs, Female BSPP Thread



	Nickel-plated brass, NBR 	C  	E	F	F1	H	L	L1	L2	M	kg
		G3/8 7 0494 07 17	11	22	16	38	60	20	15	43	0.178
Technical polymer handle											


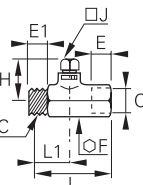


0497 2/2 Ball Valve, Square Stem, Female BSPP Thread



	Brass, NBR 	C  	E	F	H	J	L	L1	kg
		G1/4 4 0497 04 13	9	17	25	7	39	17	0.066
		G3/8 7 0497 07 17	11	22	26	7	45	20	0.122
		G1/2 10 0497 10 21	12	24	29	10	54	25	0.148
		G3/4 13 0497 13 27	14	30	30	10	62	28	0.230

0496 2/2 Ball Valve, Square Stem, Male/Female BSPP Thread



	Brass, NBR 	C  	E	E1	F	H	J	L	L1	kg
		G1/4 4 0496 04 13	7	9	17	25	7	39	17	0.065
		G3/8 7 0496 07 17	8	11	22	26	7	45	20	0.118
		G1/2 10 0496 10 21	10	12	24	29	10	53	24	0.150
		G3/4 13 0496 13 27	12	14	30	30	10	59	28	0.222



Ball Valves

Industrial Valves

Ball Valves, DVGW Series

The combination of long threads, a reinforced sealing system and **DVGW** certification makes this valve perfect for the **transmission of gas and water**.

Product Advantages

Reliability & Sealing Stem prevented from being ejected in the event of overpressure
Two stem seals to prevent leakage
Date coding to guarantee quality and traceability

Optimum Performance Full flow minimises pressure drop
Nickel-plated brass provides improved corrosion resistance and increased chemical compatibility
Can be operated at very low temperatures

Long Threads Excellent fitting compatibility:

- dimensions compliant with DIN 3357
- BSPP threads compliant with DIN 2999/ISO 228



Robotics
Pneumatics
Water & Gas Handling
Machine Tools
Textile
Wood Industry

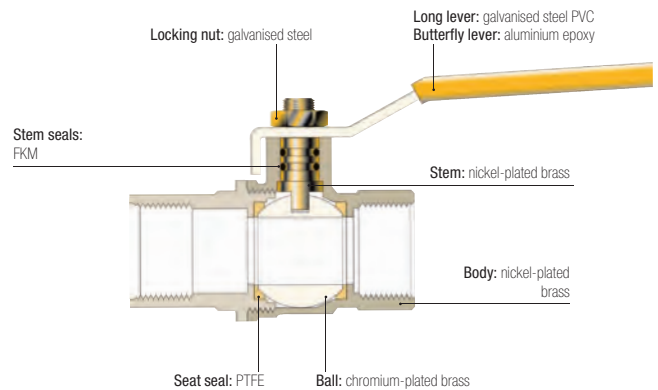
Applications

Technical Characteristics

Compatible Fluids	Compressed air, water, gas
Working Pressure	1/4" to 2": 0 to 40 bar
Working Temperature	-40°C to +170°C

Reliable performance is dependent upon the type of fluid conveyed.

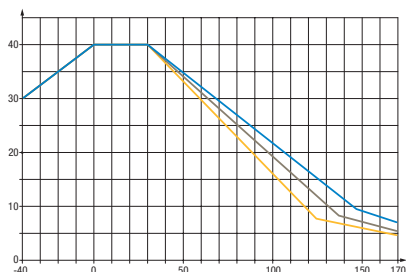
Component Materials



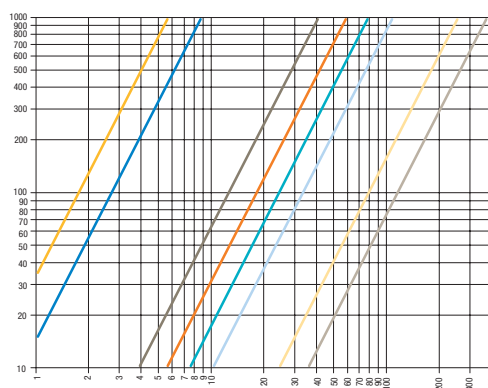
Silicone-free

Working Pressure and Temperature

Pressure - Temperature



Pressure Drop

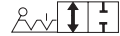


Regulations

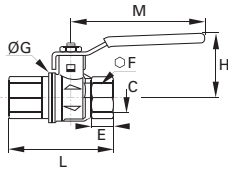
Industrial
 DI: 97/23/EC
 (PED B+D module EC 1115)
Water
 DVGW: W 570-1
 DIN EN 13228
 BGA KTW
 DVGW: W270
Gas
 DIN EN 33

DVGW Series

BVG4-L 2/2 In-Line Ball Valve, Female BSPP Thread



Nickel-plated brass, PTFE

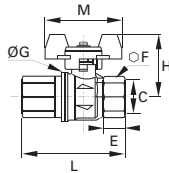


C	DN		E	F	ØG	H	L	M	kg
G1/4	8	BVG4-1/4L	12	20	25	38	50	82	0.150
G3/8	10	BVG4-3/8L	12	20	25	38	60	82	0.150
G1/2	15	BVG4-1/2L	15.5	25	32.5	43	75	100	0.255
G3/4	20	BVG4-3/4L	17	32	39	50	80	120	0.390
G1	25	BVG4-1L	21	41	47.5	54	90	120	0.590
G1¼	32	BVG4-1,1/4L	23	50	59	73	110	158	0.980
G1½	40	BVG4-1,1/2L	23	55	71.5	79	120	158	1.205
G2	50	BVG4-2L	26.5	70	86	86	140	158	1.960

BVGT4-L 2/2 In-Line Ball Valve, Female BSPP Thread



Nickel-plated brass, PTFE



C	DN		E	F	ØG	H	L	M	kg
G1/4	8	BVGT4-1/4L	12	20	25	39	50	50	0.150
G3/8	10	BVGT4-3/8L	12	20	25	39	60	50	0.150
G1/2	15	BVGT4-1/2L	15.5	25	32.5	43	75	50	0.230
G3/4	20	BVGT4-3/4L	17	32	39	47	80	60	0.350
G1	25	BVGT4-1L	21	41	47.5	51	90	60	0.550

Compact lever

Ball Valves, Standard Series

This range of valves with **fluoropolymer seals**, available in compact, standard and lockable series, covers many **industrial applications** for which the fluids conveyed and working temperatures require this seal material.

Product Advantages

Optimised Installation

- Full fluid flow
- Long or butterfly lever
- Corrosion resistance
- A lockable version for operational safety
- Good value/performance ratio

Wide Compatibility

- Numerous compatible fluids
- Can be used for low and medium pressure applications
- Surface treatment for corrosion protection



Applications

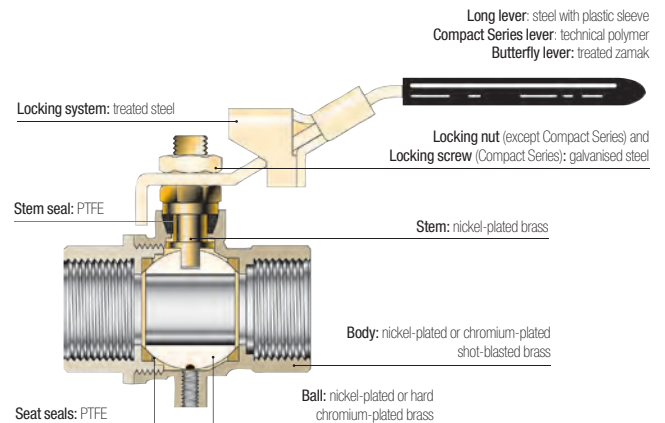
- Machine Tool
- Agricultural Machinery
- Textile
- Pneumatics
- Plumbing
- Air Conditioning
- Heating

Technical Characteristics

Model	Standard and Lockable Series	Compact Series
Compatible Fluids	Compressed air, gas, water, water vapour, oil and all fluids compatible with the component materials	
Working Pressure	0 to 30 bar	0 to 35 bar
Working Temperature	-20°C to +130°C	-10°C to +90°C

Reliable performance is dependent upon the type of fluid conveyed.

Component Materials



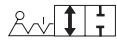
Silicone-free


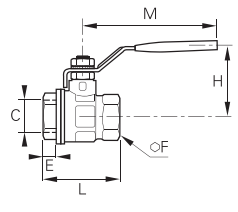

Regulations

Industrial
DI: 97/23/EC (module PED A - EC diameters greater than 25 mm)
DI: Machinery Directive 2006/42/EC
DI: 2002/95/EC (RoHS)
RG: 1907/2006 (REACH)
DI: 89/392/EC

Standard Series


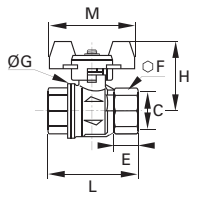

4902 2/2 Standard In-Line Ball Valve, Female BSPP Thread



		Nickel-plated brass, PTFE	C	DN		PN	E	F	H	L	M	kg
			G1/4	10	4902 10 13	30	11	20	43	51.5	98	0.154
			G3/8	10	4902 10 17	30	11.4	20	43	51.5	98	0.138
			G1/2	15	4902 15 21	30	13.5	25	47	55	98	0.202
			G3/4	20	4902 20 27	30	12.5	31	58	69.5	122	0.322
			G1	25	4902 25 34	30	15	38	60	69.5	122	0.468
			G1¼	32	4902 32 42*	25	17	48	77	81.5	153	0.794
			G1½	40	4902 40 49*	25	18	54	83	95	153	1.082
			G2	50	4902 50 48*	25	22	66	95	113	162	1.787
			G2½	65	4902 65 47*	30	22	85	132	136	255	4.500
G3	80	4902 80 46*	30	25	99	140	157	255	5.840			
G4	100	4902 01 45*	30	29	125	154	191	255	9.040			
*Models with CE marking Model from 2½": double stem seal in FPM Working temperature: -40°C to +170°C												


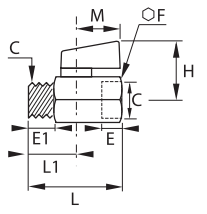

BVGT4-C 2/2 Standard In-Line Ball Valve, Female BSPP Thread



		Sand-blasted nickel-plated brass, PTFE	C	DN		E	F	G	H	L	M	kg
			G1/4	8	BVGT4-1/4C	9	20	25	40	39	50	0.130
			G3/8	10	BVGT4-3/8C	9	20	25	40	39	50	0.120
			G1/2	15	BVGT4-1/2C	11	25	32.5	44	50	50	0.180
			G3/4	20	BVGT4-3/4C	12	31	39	49	54	50	0.265
			G1	25	BVGT4-1C	14	38	47.5	53	67	50	0.390
Compact lever												


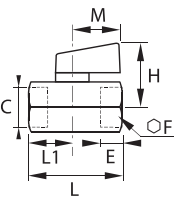

4991 2/2 Standard Compact In-Line Ball Valve, Male/Female BSPP Thread



		Chromium-plated brass, PTFE	C	DN		E	E1	F	H	L	L1	M	kg
			G1/8	6	4991 00 10	10	10	21	30	41.5	10	24	0.091
			G1/4	8	4991 00 13	11	11	21	30	41.5	11	24	0.087
			G3/8	8	4991 00 17	11	11	21	30	41.5	10.5	24	0.087
			G1/2	10	4991 00 21	13	13	25	32	49	12.5	24	0.134

4992 2/2 Standard Compact In-Line Ball Valve, Female BSPP Thread



		Chromium-plated brass, PTFE	C	DN		E	F	H	L	L1	M	kg
			G1/8	6	4992 00 10	10	21	30	41.5	10	24	0.110
			G1/4	8	4992 00 13	11	21	30	41.5	11	24	0.106
			G3/8	8	4992 00 17	11	21	30	41.5	10.5	24	0.094
			G1/2	10	4992 00 21	13	25	32	49	12.5	24	0.142

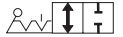
Ball Valves

Industrial Valves

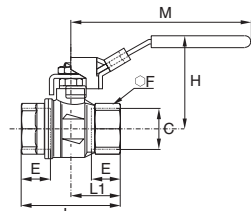
Standard Series

BVG4-LOCK

2/2 In-Line Lockable Ball Valve, Female BSPP Thread



Sand-blasted nickel-plated brass, PTFE



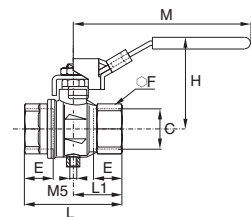
C	DN		E	F	H	L	L1	M	kg
G1/4	8	BVG4-1/4LOCK	12	20	47.5	45	22.5	96	0.154
G3/8	10	BVG4-3/8LOCK	12	20	47.5	45	22.5	96	0.171
G1/2	15	BVG4-1/2LOCK	15.5	25	52	59	29.5	96	0.238
G3/4	20	BVG4-3/4LOCK	17	31	59.5	64	32	117	0.370
G1	25	BVG4-1LOCK	21	40	63.5	81	40.5	117	0.580

BVG4P-LOCK

2/2 In-Line Lockable Vented Ball Valve, Female BSPP Thread



Sand-blasted nickel-plated brass, PTFE



C	DN		E	F	H	L	L1	M	kg
G1/4	8	BVG4P-1/4LOCK	12	20	47.5	45	22.5	96	0.155
G3/8	10	BVG4P-3/8LOCK	12	20	47.5	45	22.5	96	0.172
G1/2	15	BVG4P-1/2LOCK	15.5	25	52	59	29.5	96	0.239
G3/4	20	BVG4P-3/4LOCK	17	31	59.5	64	32	117	0.371
G1	25	BVG4P-1LOCK	21	40	63.5	81	40.5	117	0.581

Ball Valves: Usage Chart

The chart below shows the compatibility between valves and fluids along with their pressure and temperature characteristics.

Certain models have a maximum working pressure which differs from that given in this table. In this case, the pressure is shown in the heading for the model number in question.

N.B.: Above 32 mm or 1¼" diameters, divide the maximum pressure by 2.

If the fluid you are using is not shown in this chart, please contact us.

Chemical Description	Maximum Pressure (bar)	Temperature °C		Universal and Light Series	Standard Series	DVGW series	Customised Series							
		Min.	Max.				20	22	26	27	30	32		
"Aromatic" hydrocarbons	20	-20	+60					●						
Acetone and other ketones	20	-20	+60											●
Acetophenone	20	-20	+60											●
Acetylene - Acetone	20	-20	+60											●
Acetylene (gas)	20	-20	+60	●	●	●								
Alcohol (100%)	20	-20	Boiling											●
Aluminium (liquid suspension, thick)	40	-20	+90	●	●	●								
Amyl alcohol	20	-20	Boiling											●
Animal fats, greases	20	+5	+200		●	●			●					
Antifreeze or glycol (diluted)	40	-20	+40	●	●	●								
Argon (gas) Ar	20	-20	+60	●	●	●								
Barium - Hydroxide	20	-20	+40											●
Benzaldehyde	20	-20	+60											●
Benzene	20	-20	+60					●						
Benzyl alcohol	20	-20	Boiling					●						
Borax (pastes or solutions)	20	-20	+60											●
Brake fluids (automobile)	20	-20	+90											●
Bromochlorotrifluorethane	20	-20	+60		●	●			●					
Butadiene (hydrocarbon)	20	-20	+60										●	
Butane	20	-20	+60	●	●	●								
Butanol	20	-20	Boiling					●						
Butyl alcohol	20	-20	Boiling					●						
Butylene (hydrocarbon)	20	-20	+60					●						
Carbon dioxide gas CO ₂	40	-20	+60	●	●									
Castor oil	40	-20	+90	●	●									
Compressed air	20	-25	+180					●						
Creosotes	20	-20	+60										●	
Cresols	20	-20	+60										●	
Crude oil	20	-20	+40					●						
Cutting oil	40	-20	+90	●	●									
Decalin (hydrocarbon, solvent)	20	-20	+60										●	
Detergents (solutions)	20	-20	+100											●
Diacetone alcohol	20	-20	Boiling											●
Diesel oils	40	-20	+90	●	●									
Di-Esters	20	-20	+90					●						
Di-Isobutylene	20	-20	+60										●	
Di-Pentane	20	-20	+60					●						

The above recommendations are given in good faith. However, since each application is different, it is advisable to undertake tests in actual working conditions.

Ball Valves: Usage Chart

Chemical Description	Max. Pressure (bar)	Temperature °C		Universal and Light Series	Standard Series	DVGW Series	Customised Series						
		Min.	Max.				20	22	26	27	30	32	
Di-Pentene (solvents, varnish)	20	-20	+60					●					
Di-Phenyl-Oxide (thin detergents)	20	-20	+60								●		
Distilled water	40		+90	●	●	●							
Edible fats	20	+5	+200		●					●			
Edible oils	20	+5	+200		●					●			
Erytrene (see Butadiene)	20	-20	+60								●		
Ethane (gas) CH ₂ CH ₃	20	-20	+60	●	●								
Ethane (hydrocarbon gas)	20	-20	+60								●		
Ethyl alcohol	20	-20	+60										●
Ethylene glycol (antifreeze) - see Glycols	20	-20	+120										●
Fatty alcohols	20	-20	Boiling					●					
Fuel oils	40	-20	+40	●	●	●							
Fuels-Diesels	40	-20	+40	●	●								
Gaseous oxygen (ambient air)	20	-20	+40									●	
Glycerine	20	-20	+40	●	●								
Glycol (for antifreeze, lubricants)	40	-20	+40	●	●								
Graphite in suspension in water, oils and greases	40	-20	+90	●	●								
Greases (from petroleum)	40	-20	+90	●	●								
Helium (gas)	20	-20	+60									●	
Heptanal	20	-20	+50	●	●								
Hexane (solvent)	20	-20	+60									●	
Hydraulic oils (petroleum-based)	40	-20	+90	●	●								
Hydrogen (gas)	20	-20	+60									●	
Inks	20	-20	+60								●		
Insecticides	20	0	+40	●	●	●							
Iso-Butane (aliphatic hydrocarbon)	20	-20	+60								●		
Iso-Octane	20	-20	+60								●		
Isopropyl alcohol	20	-20	Boiling										●
Krypton (gas) Kr	20	-20	+60	●	●	●							
Light water	40		+80	●	●	●							
Lighting gas	20	-20	+40			●							
Methane (gas) CH ₄	20	-20	+60	●	●	●							
Methanol	20	-20	Boiling										●
Methyl alcohol	20	-20	Boiling										●
Methylated spirit	40	-20	+40	●	●	●							
Mineral oils	40	-20	+90	●	●								
Natural gas	20	-20	+40			●							
Natural waxes (vegetable, beeswax, carnauba, Chinese, lignite)	40	-20	+90								●		
Neatsfoot oil	40	-20	+90	●	●	●							
Neon (Gas) Ne	20	-20	+60	●	●	●							
Nitrogen (gas) N ²	40	-20	+90	●	●	●							
Oil (petroleum-based) and water emulsions	40	-20	+90	●	●	●							

The above recommendations are given in good faith. However, since each application is different, it is advisable to undertake tests in actual working conditions.

Ball Valves, Stainless Steel Series

Stainless steel series ball valves can withstand **corrosive fluids** and **environments**.

With full flow, high pressure and temperature capabilities, these valves are suitable for many applications.

Product Advantages

Reliability

- Full flow
- Excellent chemical compatibility
- High resistance to pressure/temperature
- Light series version: 100% leak-tested in production, date coding to guarantee quality and traceability

Versatility

Three in-line versions:

- One-piece: cannot be disassembled
- 3-piece: easily disassembled for maintenance and cleaning
- Light Series: for maximum compactness

Fixing plate: 4812 and 4832

- Through-bulkhead fitting
- Pneumatic or electronic actuation (ISO 5211 standard)



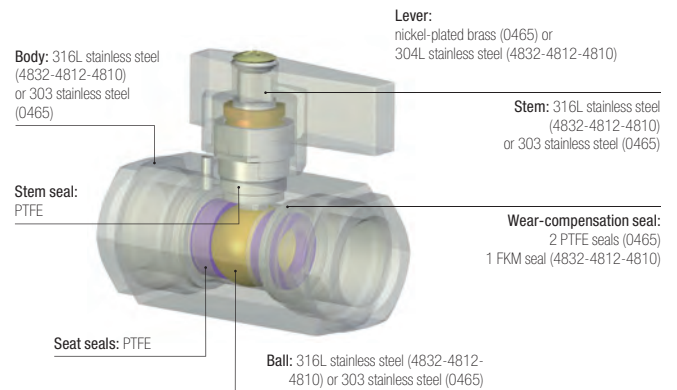
Applications

- Food Process
- Aviation
- Chemical
- Semi-Conductors
- Medical
- Petrochemical
- Laboratories
- Pharmaceutical

Technical Characteristics

Compatible Fluids	Type 4810, 4812 and 4832	Type 0465
	All fluids	All fluids
Working Pressure	0 to 65 bar	Vacuum to 20 bar
Working Temperature	-20°C to +150°C	-20°C to +120°C

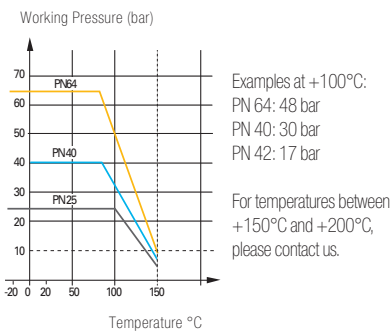
Component Materials



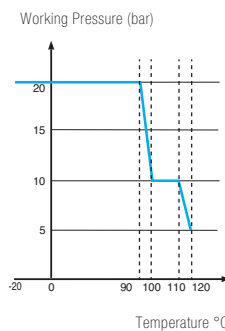
Reliable performance is dependent upon the type of fluid conveyed, component materials and tubing being used. Guaranteed for use with a vacuum of 755 mm Hg (99% vacuum).

Pressure and Temperature Resistance

Version 4810, 4812 and 4832



Version 0465



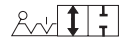
Regulations

Industrial

- DI: 97/23/EC (module PED A - EC diameters greater than 25 mm)
- DI: Machinery Directive 2006/42/EC
- DI: 2002/95/EC (RoHS)
- RG: 1907/2006 (REACH)
- DI: 89/392/EC

Stainless Steel Series

4832 2/2 In-Line 3-Piece Ball Valve with Fixing Plate, Female BSPP Thread



Stainless steel 316L, PTFE		C	DN		E	F	G	H	K	L	M	ØT	kg
		G1/4	10	4832 10 13	18	22	36	50	36	57	110.5	5.5	0.272
		G3/8	10	4832 10 17	18	22	36	50	36	57	110.5	5.5	0.400
		G1/2	15	4832 15 21	20.5	27	36	64	36	65	131.5	6	0.442
		G3/4	20	4832 20 27	22.5	32	42	68	42	76	131.5	5.5	0.568
		G1	25	4832 25 34	27	41	42	78.5	42	92	174.5	6	1.035
		G1¼	32	4832 32 42*	30	50	42	83.5	42	106.5	174.5	5.5	1.530
		G1½	40	4832 40 49*	31	55	50	100	50	116	250.5	6.5	2.146
		G2	50	4832 50 48*	36	70	50	107	50	136	250.5	6.5	3.140

*Models with CE marking

4812 2/2 In-Line Ball Valve with Fixing Plate, Female BSPP Thread



Stainless steel 316L, PTFE		C	DN		E	G	H	L	M	ØT	kg
		G1/4	10	4812 10 13	10	36	50	55	110	5.5	0.263
		G3/8	10	4812 10 17	11	36	50	55	110	5.5	0.254
		G1/2	15	4812 15 21	15	36	53	66	110	5.5	0.336
		G3/4	20	4812 20 27	16	42	67	79	130	5.5	0.574
		G1	25	4812 25 34	19	42	79	93	175	5.5	1.000
		G1¼	32	4812 32 42*	21	42	83	100	175	5.5	1.337
		G1½	40	4812 40 49*	21	50	100	110	250	5.5	2.214
		G2	50	4812 50 48*	26	70	107	131	250	8.5	3.262

*Models with CE marking

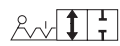
4810 2/2 In-Line Ball Valve, Female BSPP Thread



Stainless steel 316L, PTFE		C	DN		E	G	H	L	M	kg
		G1/4	8	4810 08 13	10	30	44.5	53.5	110.5	0.205
		G3/8	10	4810 10 17	10	30	44.5	53.5	110.5	0.194
		G1/2	15	4810 15 21	13	32.5	47	60	110.5	0.245
		G3/4	20	4810 20 27	14	40	54.5	70	131.5	0.420
		G1	25	4810 25 34	17	49	58.5	79	131.5	0.648

Threads conform to ISO 228-1

0465 2/2 In-Line Light Series Ball Valve, Female BSPP Thread



Stainless steel 303, PTFE		C	DN		E	F	F1	H	L	kg
		G1/4	4	0465 04 13	13	19	24	36	50	0.226
		G3/8	7	0465 07 17	13	24	27	39	55	0.278
		G1/2	10	0465 10 21	16	27	30	40	62	0.322

Silicone-free

Ball Valves
Industrial Valves

Ball Valves, High Pressure Series

These valves are suitable for **applications** with pressures **up to 300 bar**. High performance materials and quality manufacturing allow for a wide range of operating pressures and temperatures.

Product Advantages

High Pressure & Safety

- Good sealing at low and high pressure
- Robust design with secure, non-removable inlet and outlet ports
- Forged brass providing excellent long-term strength under severe conditions of use
- 100% leak-tested in production
- Date coding to guarantee quality and traceability

Easy-to-Use

- Fixing screws for through-bulkhead mounting
- The lever may be repositioned or replaced with a handwheel
- Low operating torque



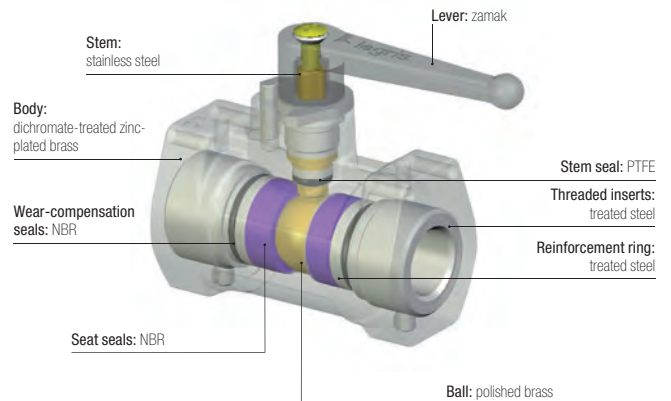
- Applications**
- Automotive Process
 - Foundry
 - Forming
 - Machine Tools
 - Textile
 - Spectacle-Making Industry
 - Turbines
 - Deep-Sea Diving

Technical Characteristics

Compatible Fluids	Compressed air
Working Pressure	Vacuum to 300 bar
Working Temperature	-15°C to +80°C

Reliable performance is dependent upon the type of fluid conveyed, component materials and tubing being used. Guaranteed for use with a vacuum of 755 mm Hg (99% vacuum).

Component Materials



Silicone-free

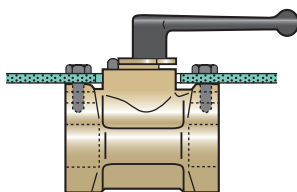
Regulations

- DI: 97/23/EC (module PED A - diameters greater than 25 mm)
- DI: 2006/42/EC (Machinery Directive)
- DI: 2002/95/EC (RoHS)
- RG: 1907/2006 (REACH)

Installation Options

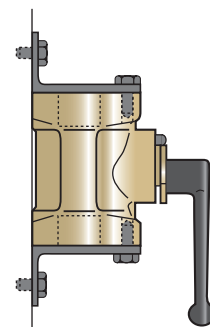
Bulkhead Mounting

Through bulkhead with screws



Surface Mounting

With brackets and screws


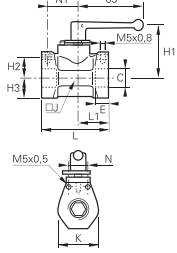



High Pressure Series

4402

2/2 In-Line High Pressure Ball Valve, Female BSPP Thread



	<p>Treated brass, NBR</p> 	C	DN		E	H1	H2	H3	J	K	L	L1	N	N1	kg
		G1/4	7	4402 07 13	12	50	13	15	30	30	58	25	15	20	0.402
		G3/8	10	4402 10 17	12	54	23	19	36	39	72	36	20	30	0.722
		G1/2	13	4402 13 21	15	56	23	21	40	42	79	36	20	30	0.870

Ball Valves, Mini Series

With their **push-in connections**, these polymer lightweight ball valves allow for a significant reduction in installation time while offering **full flow capability** and **compact dimensions**.

Product Advantages

Optimum Solution

- Full flow
- Marked with the pneumatic symbol for identification of its function
- Lightweight and compact
- Extremely compact, easy-to-operate lever
- Lever with screwdriver slot to facilitate operation
- Designed for polymer tubing with no tube preparation
- Can be mounted on a wall or adjacent using staples



Proven Technology

- LF 3000® push-in connection, excellent static and dynamic sealing
- High-strength polyamide
- Excellent long-term performance
- Automatic seal wear compensation for long-term reliability
- 100% leak-tested in production
- Date coding to guarantee quality and traceability

- Applications**
- Robotics
 - Vacuum
 - Semi-Conductors
 - Packaging
 - Textile
 - Pneumatics

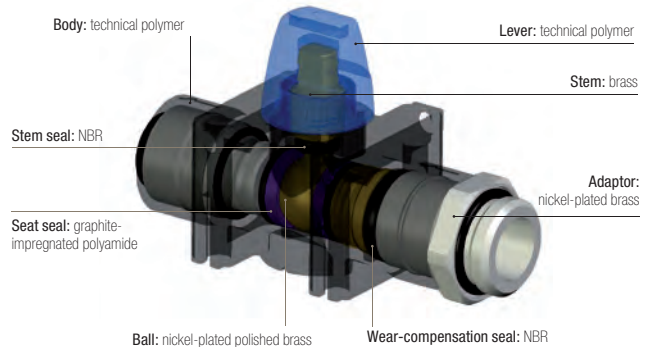
Technical Characteristics

Compatible Fluids	Compressed air			
Working Pressure	Vacuum to 10 bar			
Working Temperature	-20°C to +80°C			

Tightening Torques	Threads	G1/8	G1/4	G3/8	G1/2
	daN.m	0.8	1.2	3	3.5

Reliable performance is dependent upon the type of fluid conveyed, component materials and tubing being used.
Guaranteed for use with a vacuum of 755 mm Hg (99 % vacuum).

Component Materials

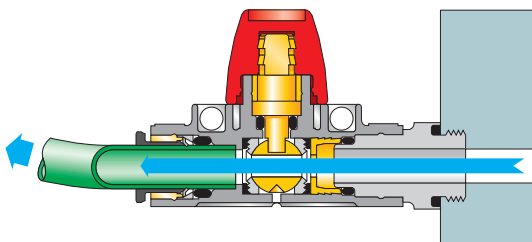


Silicone-free

Operation

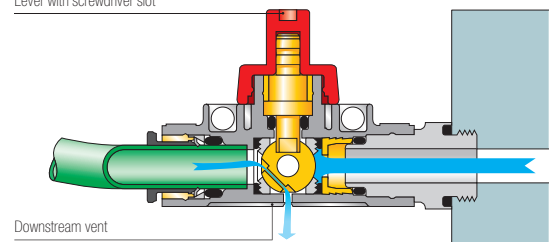
Vented Valve, Open Position

3/2 model with vent



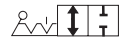
Vented Valve, Closed Position


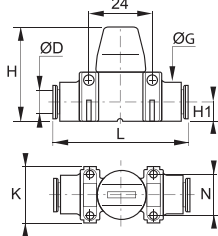

Lever with screwdriver slot



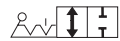
Mini Series


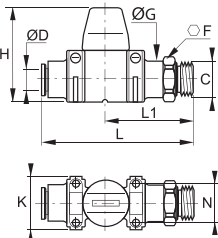

7910 2/2 In-Line Mini-Ball Valve



	<p>Technical polymer, NBR</p> 	ØD		G	H	H1	K	L	N	kg
		4	7910 04 00	15	37	7.5	22	51	16	0.039
		6	7910 06 00	15	37	7.5	22	52	16	0.034
		8	7910 08 00	15	37	7.5	22	52	16	0.025
		10	7910 10 00	20	43	11	30	66	22	0.060
		12	7910 12 00	20	43	11	30	66	22	0.040


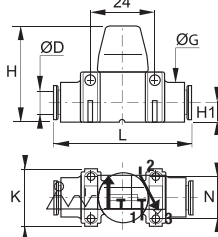

7911 2/2 In-Line Mini-Ball Valve, Male BSPP Thread



	<p>Technical polymer, nickel-plated brass, NBR</p> 	ØD	C		F	G	H	K	L	L1	N	kg
		6	G1/8	7911 06 10	13	14	37	22	62	37	16	0.045
		8	G1/4	7911 08 13	16	17.5	37	22	61	35	16	0.040
		10	G3/8	7911 10 17	20	22	43	30	74	41	22	0.075
		12	G1/2	7911 12 21	24	26	43	30	75	42	22	0.075


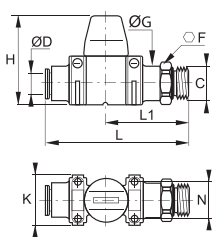

7913 3/2 In-Line Mini-Ball Valve with Vent






	<p>Technical polymer, NBR</p> 	ØD		G	H	H1	K	L	N	kg
		4	7913 04 00	15	37	7.5	22	51	16	0.040
		6	7913 06 00	15	37	7.5	22	52	16	0.035
		8	7913 08 00	15	37	7.5	22	52	16	0.025
		10	7913 10 00	20	43	11	30	66	22	0.060
		12	7913 12 00	20	43	11	30	66	22	0.045

7914 3/2 In-Line Mini-Ball Valve with Vent, Male BSPP Thread



	<p>Technical polymer, nickel-plated brass, NBR</p> 	ØD	C		F	G	H	K	L	L1	N	kg
		6	G1/8	7914 06 10	13	14	37	22	62	37	16	0.045
		8	G1/4	7914 08 13	16	17.5	37	22	61	35	16	0.040
		10	G3/8	7914 10 17	20	22	43	30	74	41	22	0.058
		12	G1/2	7914 12 21	24	26	43	30	75	42	22	0.075

7000 Joining Clips

	<p>Technical polymer</p> 	ØD		kg
		4	7000 00 05	0.004
		6	7000 00 05	0.004
		8	7000 00 05	0.004
		10	7000 00 06	0.009
		12	7000 00 06	0.009

LIQUIfit® Ball Valves

This range of valves offers an innovative solution in the treatment of **water and the handling of beverages** while protecting **health**. These **compact and reliable** valves offer perfect **sealing** and excellent **cleanliness**.

Product Advantages

Innovative Technology & Increased Reliability

- Full flow to limit turbulence
- Full-flow self-cleaning ball maintains the cleanliness of the circuit
- Tube retention with gripping ring prevents pumping effect
- Push-in connection and disconnection
- Sealing technology using patented EPDM seal

High Performance

- Inert technical polymer providing the best mechanical strength, thermal and chemical resistance
- Carstick® connection providing resistance to water hammer
- Other configurations available on request

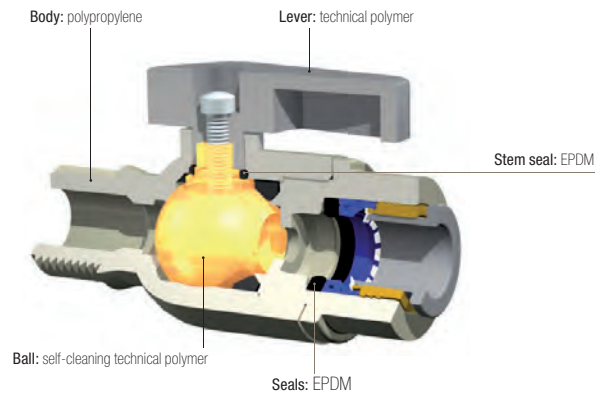


- Applications**
- Beverage Dispensers
 - Inert Gases
 - Cooling
 - Food Process
 - Water Purification
 - Water Coolers

Technical Characteristics

Compatible Fluids	Water, drinks, beverages			
Working Pressure	0 to 10 bar at 20°C			
Working Temperature	-15°C to +100°C			
Tightening Torques	Threads	1/4" NPTF	3/8" NPTF	1/2" NPTF
	daN.m	1.5	3	3

Component Materials



Silicone-free


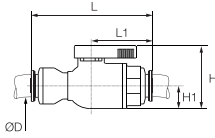
Regulations

- FDA: 21 CFR
- NSF: 51 and lead < 0.25%
- WQA: Water Quality Association

LIQUIfit® Ball Valves


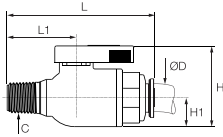
4020 2/2 In-Line Ball Valve

Inch

	Polypropylene, glass fibre-reinforced, EPDM 	ØD		H	H1	L	L1	kg
		1/4	4020 56 00WP2	25	13	65	31	0.015
		3/8	4020 60 00WP2	36	13	68	30.5	0.028


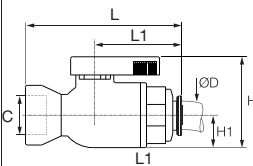
4021 2/2 In-Line Ball Valve, Male NPTF Thread

Inch

	Polypropylene, glass fibre-reinforced, EPDM 	ØD	C		H	H1	L	L1	kg
		1/4	NPT1/4	4021 56 14WP2	36	13	61	31	0.029
		3/8	NPT3/8	4021 60 18WP2	36	13	64	33.5	0.028


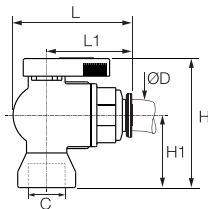
4023 2/2 In-Line Ball Valve, Female NPTF Thread

Inch

	Polypropylene, glass fibre-reinforced, EPDM 	ØD	C		H	H1	L	L1	kg
		1/4	NPT1/4	4023 56 14WP2	36	13	58	31	0.000
		3/8	NPT3/8	4023 60 18WP2	36	13	64	33.5	0.000

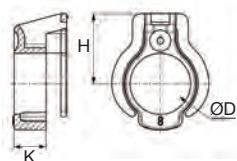
4022 2/2 Right-Angled Ball Valve, Female NPTF Thread

Inch

	Polypropylene, glass fibre-reinforced, EPDM 	ØD	C		H	H1	L	L1	kg
		1/4	NPT1/4	4022 56 14WP2	52	29	44	31	0.016
		3/8	NPT3/8	4022 60 18WP2	52	29	47	33.5	0.027

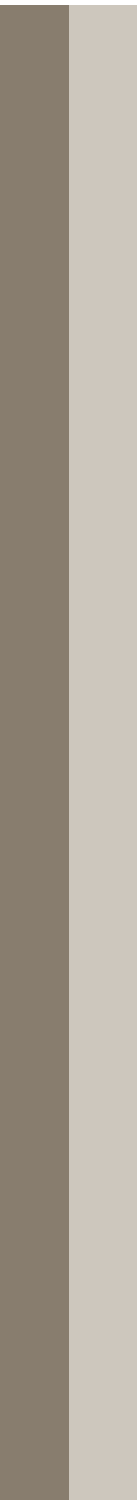
3130 Tamper-Proof Safety Clip

Technical polymer



ØD							H	K	kg
1/4	3130 56 01	3130 56 02	3130 56 03	3130 56 04	3130 56 05	3130 56 10	8	3.2	0.001
3/8	3130 60 01	3130 60 02	3130 60 03	3130 60 04	3130 60 05	3130 60 10	10.8	4.2	0.001

Ball Valves
Industrial Valves



Needle and Butterfly Valves

Brass Needle Valve

In-Line

0502
Page 6-39

0501
Page 6-39

0510
Page 6-39



Right-Angled

0532
Page 6-39

0531
Page 6-39



Drain Valve

0562
BSPP/Metric
Page 6-40

0563
NPT
Page 6-40



Venting Pressure Gauge Valve

0627
BSPP
Page 6-40



Pressure Relief Valve

0630
BSPP
Page 6-40



Stainless Steel Needle Valve

In-Line

0591
Page 6-41



Butterfly Valve

In-Line

4602
Page 6-43



Needle Valves

Parker Legris compact needle valves can be installed in any system and are designed for applications requiring accurate **leak-free fluid control** and **excellent service life**.

Product Advantages

- Robust and Easy-to-Use**
 - Accurate flow control
 - Forged brass for improved long-term mechanical strength
 - Robust stem for good operational reliability
 - Corrosion resistance
- Wide Range**
 - Two materials (nickel-plated brass and stainless steel) suitable for many applications
 - Numerous valve and safety accessory configurations



Pneumatics
Water Circuits
Machine Tools
Rubber Industry
Packaging
Textile

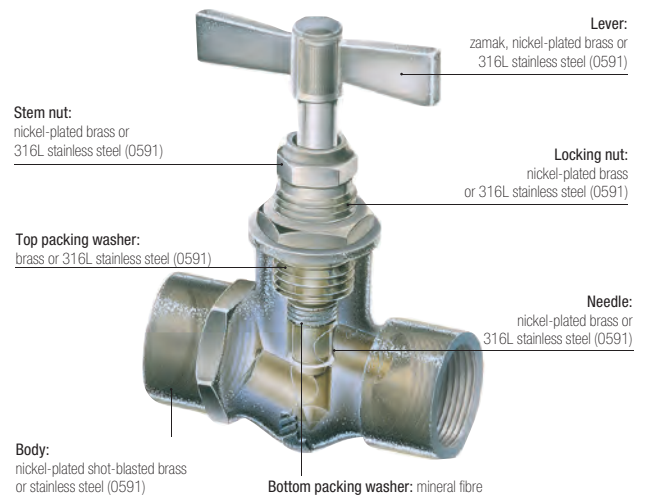
Applications

Technical Characteristics

	Brass	Stainless Steel			
Compatible Fluids	Compressed air, water, industrial fluids, etc. Other fluids: contact us	Many fluids			
Working Pressure	0 to 120 bar	0 to 400 bar			
Working Temperature	-20°C to +100°C (except model 0510)	-20°C to +180°C			
Tightening Torques	Threads	G1/8	G1/4	G3/8	G1/2
	daN.m	0.10 to 0.20	0.10 to 0.20	0.15 to 0.25	0.20 to 0.35

Reliable performance is dependent upon the type of fluid conveyed.

Component Materials



Silicone-free


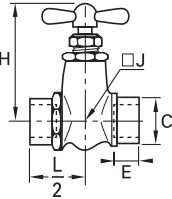

Regulations

- DI: 97/23/EC (module PED A - diameters greater than 25 mm)
- DI: 2006/42/EC (Machinery Directive)
- DI: 2002/95/EC (RoHS)
- RG: 1907/2006 (REACH)

Brass Needle Valves


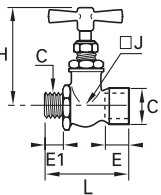

0502 In-Line Needle Valve, Female BSPP Thread



	Nickel-plated brass 	C	DN		E	H	H_{max}	J	L/2	kg
		G1/8	4	0502 04 10	9	56	50	17	23	0.133
		G1/4	4	0502 04 13	11	56	50	17	23	0.118
		G3/8	6	0502 06 17	12	67	60	-	26	0.171


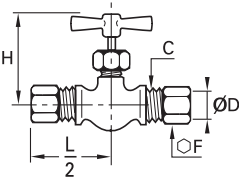

0501 In-Line Needle Valve, Male/Female BSPP Thread



	Nickel-plated brass 	C	DN		E	E1	H	H_{max}	J	L	kg
		G1/8	4	0501 04 10	9	7	56	50	17	44	0.118
		G1/4	4	0501 04 13	11	9.5	56	50	17	46	0.115
		G3/8	6	0501 06 17	12	9.5	67	60	-	48	0.158

0510 In-Line Needle Valve with Compression Connections


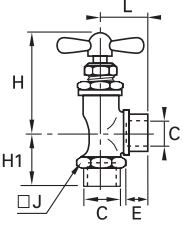



	Nickel-plated brass 	ØD	C	DN		F	H_{min}	H_{max}	L/2	kg
		6	M10x1	4	0510 04 06	13	42	46	29	0.083
		8	M12x1	8	0510 05 08	14	42	46	30	0.083
		10	M16x1.5	5	0510 05 10	19	42	46	31	0.111

The needle is sealed by an O-ring.
 Maximum operating pressure: Ø4: 100 bar, Ø5: 60 bar
 Working temperature: -15°C to +70°C
 Tightening torques: please refer to the Compression Fittings chapter of this catalogue.


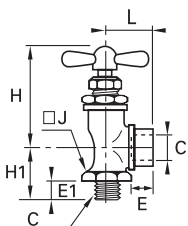

0532 Right-Angle Needle Valve, Female BSPP Thread



	Nickel-plated brass 	C	DN		E	H_{min}	H_{max}	H1	J	L	kg
		G1/8	4	0532 04 10	9	46	52	19	17	19	0.093
		G1/4	4	0532 04 13	11	46	52	21	17	21	0.087
			6	0532 06 13	11	55	63	26	22	26	0.169


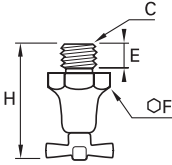


0531 Right-Angle Needle Valve, Male/Female BSPP Thread




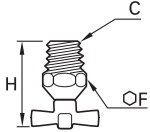


	Nickel-plated brass 	C	DN		E	E1	H_{min}	H_{max}	H1	J	L	kg
		G1/8	4	0531 04 10	7	9	46	52	19	17	19	0.082
		G1/4	4	0531 04 13	9.5	11	46	52	21	17	21	0.090
		G1/4	6	0531 06 13	9.5	11	55	63	25	22	26	0.155
		G3/8	6	0531 06 17	9.5	12	55	63	25	22	27	0.153
		G1/2	10	0531 10 21	13	16	62	72	34	26	33	0.330

Brass Needle Valves


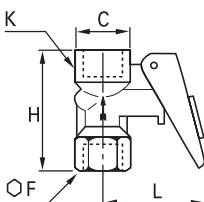

0562 Needle Drain Valve, Male BSPP and Metric Thread

	Brass		C			E	F	H	H	kg
			M10x1	5	0562 05 60	8	16	37.5	40	0.031
			G1/8	5	0562 05 10	8	16	36	40	0.032
			G1/4	5	0562 05 13	10	19	38.5	42.5	0.040

0563 Needle Drain Valve, Male NPT Thread


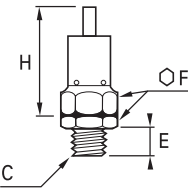

	Brass		C			F	H	H	kg
			NPT1/4	5	0563 05 14	14	28.5	32.5	0.021

0627 Automatic Vent Pressure Gauge Valve, Female BSPP Thread

	Nickel-plated brass, NBR		C		F	H	K	L	kg
			G1/4	0627 00 13	19	43.5	20	40	0.097

Pressure: 10 bar
 This isolating valve is used to connect a pressure gauge to a circuit.
 Resetting the lever isolates and vents the gauge.
 A locking pin can be used to enable the gauge to be fitted permanently.

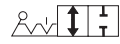
0630 Pressure Relief Valve, Male BSPP Thread


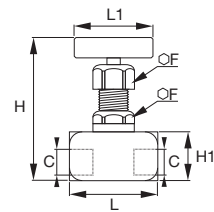

	Brass		C		E	F	H	kg
			G1/4	0630 06 13	9	17	42.5	0.050

This valve is delivered without calibration, but can be adjusted by inserting metal washers into the hexagon (F).

Stainless Steel Needle Valves

0591 Needle Valve, Female BSPP Thread



	<p>Stainless steel 316L, PTFE</p> 	C	DN		F	H min	H max	H1	L	L1	kg
		G1/8	3	0591 03 10	22	90	99	25	45	48	0.345
		G1/4	4	0591 04 13	22	90	99	25	50	48	0.356
		G3/8	5	0591 05 17	22	90	104	30	56	48	0.430
		G1/2	6	0591 06 21	22	90	104	30	62	48	0.483

Needle and Butterfly Valves
Industrial Valves

Butterfly Valves

In these robust valves, the internal component used to shut off the flow is a segment of a sphere. This allows **frequent operation with very low torque, no fluid retention areas** and therefore excellent mechanical performance.

Product Advantages

Compact & Abrasion-Resistant

- Excellent with abrasive fluids (including solid particles)
- Fluid flow direction marked for greater safety (uni-directional)
- Smooth operation
- Can be easily adapted for use with auxiliary actuators
- More compact than a ball valve with equivalent nominal diameter
- Simple and efficient design for a long service life

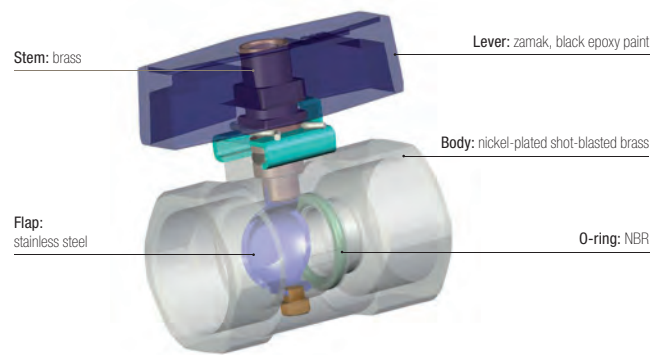
- ### Applications
- Painting & Printing
 - Machine Tools
 - Pneumatics
 - Powder Conveyance
 - Plumbing
 - Rubber Industry
 - Petrochemical

Technical Characteristics

Compatible Fluids	Compressed air, industrial gases, water, cutting oils, hydraulic oils, fuel oil, fuel, etc.
Working Pressure	0 to 16 bar
Working Temperature	-20°C to +80°C

Reliable performance is dependent upon the type of fluid conveyed.

Component Materials



Silicone-free


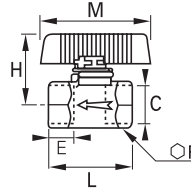

Regulations

- DI: 97/23/EC (module PED A - diameters greater than 25 mm)
- DI: 2006/42/EC (Machinery Directive)
- DI: 2002/95/EC (RoHS)
- RG: 1907/2006 (REACH)

Butterfly Valves

4602 2/2 Butterfly Shut-Off Valve, Female BSPP Thread



	<p>Nickel-plated brass, NBR</p> 	C	DN		E	F	H	L	M	kg
		G1/4	6	4602 06 13	9	17	35	34	54	0.098
		G3/8	7	4602 07 17	11	22	35	39	54	0.136
		G1/2	10	4602 10 21	12	24	37	42	54	0.140
		G3/4	13	4602 13 27	14	30	40	49	54	0.208
G1	18	4602 18 34	15	41	46	55	54	0.412		
<p>Black epoxy-coated zamak handle</p>										

Axial Valve Range

In-Line Normally Closed

4202..20

FKM Seal
2/2
Page 6-48



4202..30

EPDM Seal
2/2
Page 6-48



In-Line Normally Open

4212..20

FKM Seal
2/2
Page 6-48



4212..30

EPDM Seal
2/2
Page 6-48



In-Line Double-Acting

4222..20

FKM Seal
2/2
Page 6-48



4222..30

EPDM Seal
2/2
Page 6-49



Accessories

4298

Sub-Base
Page 6-49



4298

Solenoid Valve
Page 6-49



4299

Pneumatic Button
Page 6-49



Axial Valves

The Parker Legris axial valve is the only valve to incorporate both the **valve and actuation function**. With pneumatic or electro-pneumatic control, it avoids many of the restrictions associated with traditional actuators.

Product Advantages

Optimisation & Safety

- Very compact: up to 50% smaller than valves with separate actuators
- Simple to install: ready-to-use
- Common sub-base for solenoid control
- Automation of the open/close function
- Operation independent of the upstream and downstream pressure in the circuit

Comprehensive Offer

- Two seal materials for a wider chemical and temperature range
- Pneumatic, electro-pneumatic or dual actuation control
- Three versions: normally closed, normally open and double-acting

Performance

- Full flow: low pressure drop
- Excellent pressure/temperature performance
- Compatible with many industrial fluids



- Applications**
- Flow Control
 - Plastic Injection Moulding
 - Rubber Industry
 - Pneumatics
 - Textile
 - Printing
 - Packaging
 - Robotics

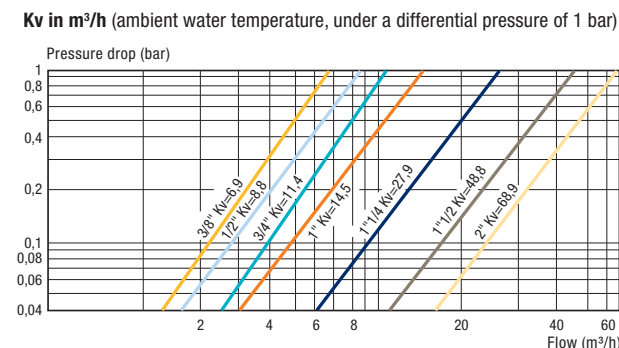
Technical Characteristics

Compatible Fluids	Depending on type of seal – FKM: water, air, oils, greases, etc. – EPDM: hot water, air, steam, etc.
Working Pressure	10 bar max.
Pilot Pressure	NC and NO: 4.2 to 8 bar Double-acting: 3 to 8 bar
Working Temperature	-20°C to +135°C (suffix 20 FKM) -20°C to +120°C (suffix 30 EPDM)

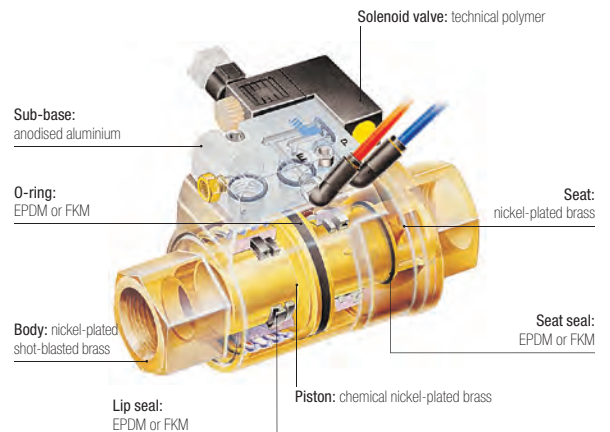
Tightening Torques	Threads	G3/8	G1/2	G3/4	G1	G1¼	G1½	G2
	daN.m	0.15 to 0.25	0.20 to 0.35	0.50 to 0.70	0.50 to 0.70	0.40 to 0.60	0.80 to 1.20	0.80 to 1.20

Reliable performance is dependent upon the type of fluid conveyed, component materials and tubing being used.
Guaranteed for use with a vacuum of 740 mm Hg (97% vacuum).

Flow Curve and Pressure Drop (Kv)



Component Materials



Silicone-free

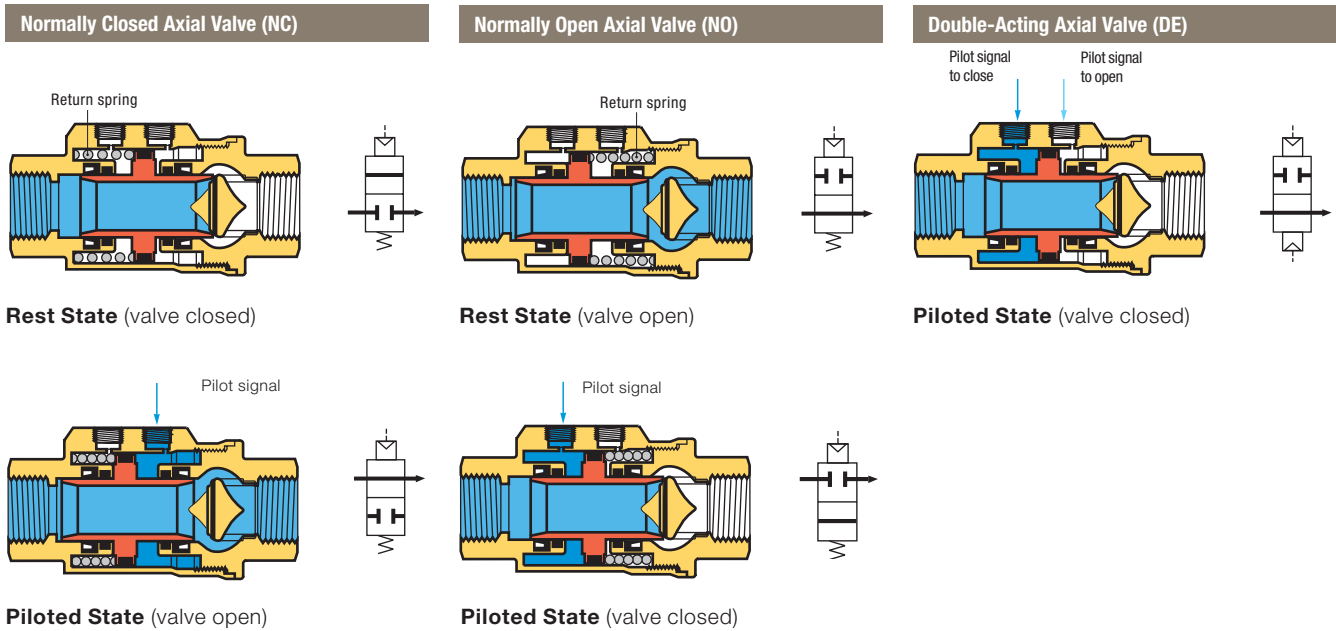
Regulations

- DI: 97/23/EC (module PED A - diameters greater than 25 mm)
- DI: 2006/42/EC (Machinery Directive)
- DI: 2002/95/EC (RoHS)
- RG: 1907/2006 (REACH)
- DI: 94/9/EC (ATEX) - for pneumatic operation versions

Axial Valves

Operation

Depending on operational requirement, air is passed into the actuation chamber to open or close the valve.



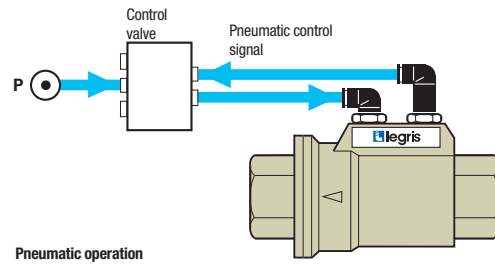
Installation Options

The **Parker Legris** axial valve offers 3 different control methods dependant on the requirements of the installation:

Pneumatic Control

Example: Double-acting axial valve 4222

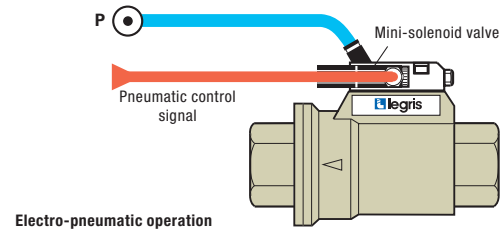
- local compressed air control
- for repetitive on/off cycles
- remote control where access to the machine is difficult
- for explosive or explosion prevention areas



Electro-Pneumatic Control

Example: Normally closed axial valve 4202 + sub-base and Mini-solenoid valve 4298

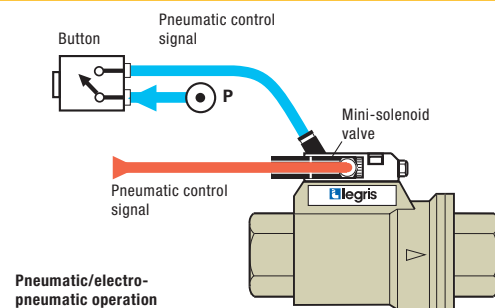
- for automated industrial systems requiring remote control
- Namur seating plane solenoid valve



Dual Pneumatic and Electro-Pneumatic Control


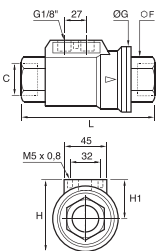

Example: Normally open axial valve 4212 + sub-base and Mini-solenoid valve 4298 + Pneumatic push-button 4299

- dual control structure
- for increased safety: prevents localised operating errors
- Namur seating plane solenoid valve


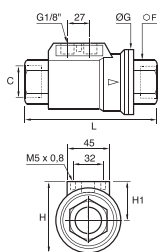



Axial Valves


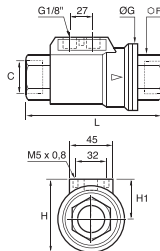

4202..20 Normally Closed Axial Valve with FKM Seal, Female BSPP Thread

	<p>Nickel-plated brass, FKM</p> 	C		F	G	H	H1	L	kg
		G3/8	4202 10 17 20	22	46	54	31	98	0.815
		G1/2	4202 15 21 20	27	52	60	35	112	1.092
		G3/4	4202 20 27 20	33	64	70	38	135	1.624
		G1	4202 25 34 20	41	69	76	41.5	143	2.033
		G1¼	4202 32 42 20*	50	86	91	48	165	3.266
		G1½	4202 40 49 20*	60	96	102	54	180	4.195
		G2	4202 50 48 20*	75	109	115	60.5	207	6.465
<p>Pilot port: G1/8 - Delivered with a silencer *Models with CE marking</p>									


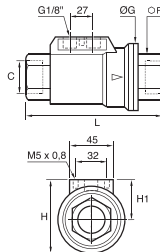

4202..30 Normally Closed Axial Valve with EPDM Seal, Female BSPP Thread

	<p>Nickel-plated brass, EPDM</p> 	C		F	G	H	H1	L	kg
		G3/8	4202 10 17 30	22	46	54	31	98	0.828
		G1/2	4202 15 21 30	27	52	60	35	112	1.098
		G3/4	4202 20 27 30	33	64	70	38	135	1.624
		G1	4202 25 34 30	41	69	76	41.5	143	1.998
		G1¼	4202 32 42 30*	50	86	91	48	165	3.315
		G1½	4202 40 49 30*	60	96	102	54	180	4.195
		G2	4202 50 48 30*	75	109	115	60.5	207	6.360
<p>Pilot port: G1/8 - Delivered with a silencer *Models with CE marking</p>									


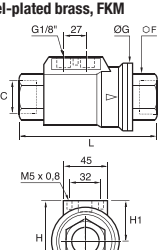

4212..20 Normally Open Axial Valve with FKM Seal, Female BSPP Thread

	<p>Nickel-plated brass, FKM</p> 	C		F	G	H	H1	L	kg
		G3/8	4212 10 17 20	22	46	54	31	98	0.829
		G1/2	4212 15 21 20	27	52	60	35	112	1.100
		G3/4	4212 20 27 20	33	64	70	38	135	1.637
		G1	4212 25 34 20	41	69	76	41.5	143	2.037
		G1¼	4212 32 42 20*	50	86	91	48	165	0.030
		G1½	4212 40 49 20*	60	96	102	54	180	4.188
		G2	4212 50 48 20*	75	109	115	60.5	207	6.555
<p>Pilot port: G1/8 - Delivered with a silencer *Models with CE marking</p>									

4212..30 Normally Open Axial Valve with EPDM seal, Female BSPP Thread


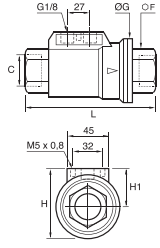

	<p>Nickel-plated brass, EPDM</p> 	C		F	G	H	H1	L	kg
		G3/8	4212 10 17 30	22	46	54	31	98	0.827
		G1/2	4212 15 21 30	27	52	60	35	112	1.152
		G3/4	4212 20 27 30	33	64	70	38	135	1.575
		G1	4212 25 34 30	41	69	76	41.5	143	2.055
		G1¼	4212 32 42 30*	50	86	91	48	165	3.301
		G1½	4212 40 49 30*	60	96	102	54	180	4.775
		G2	4212 50 48 30*	75	109	115	60.5	207	6.360
<p>Pilot port: G1/8 - Delivered with a silencer *Models with CE marking</p>									

4222..20 Double-Acting Axial Valve with FKM Seal, Female BSPP Thread


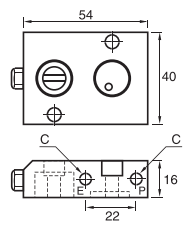

	<p>Nickel-plated brass, FKM</p> 	C		F	G	H	H1	L	kg
		G3/8	4222 10 17 20	22	46	54	31	98	0.802
		G1/2	4222 15 21 20	27	52	60	35	112	1.063
		G3/4	4222 20 27 20	33	64	70	38	135	1.572
		G1	4222 25 34 20	41	69	76	41.5	143	1.942
		G1¼	4222 32 42 20*	50	86	91	48	165	3.058
		G1½	4222 40 49 20*	60	96	102	54	180	3.995
		G2	4222 50 48 20*	75	109	115	60.5	207	6.275
<p>Pilot port: G1/8 *Models with CE marking</p>									

Axial Valves




4222..30 Double Acting Axial Valve with EPDM seal, Female BSPP Thread

	<p>Nickel-plated brass, EPDM</p> 	C		F	G	H	H1	L	kg
		G3/8	4222 10 17 30	22	46	54	31	98	0.832
		G1/2	4222 15 21 30	27	52	60	35	112	1.046
		G3/4	4222 20 27 30	33	64	70	38	135	1.662
		G1	4222 25 34 30	41	69	76	41.5	143	1.938
		G1¼	4222 32 42 30*	50	86	91	48	165	3.301
		G1½	4222 40 49 30*	60	96	102	54	180	4.260
		G2	4222 50 48 30*	75	109	115	60.5	207	6.520
<p>Pilot port: G1/8 Delivered with a silencer *Models with CE marking</p>									


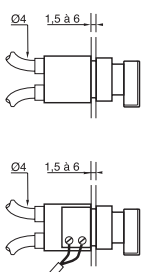

4298 Sub-Base for Solenoid Pilot Valve

	<p>Treated aluminium, NBR</p> 	C		kg
		M5x0.8	4298 00 01	0.095
<p>The sub-base is fitted directly to the axial valve and allows the mounting of a 15x15 solenoid valve. Supplied with 2 fixing bolts, silencer and seals.</p>				

4298 Mini-Solenoid Valve 1W/12VA

	<p>Anodised aluminium</p> 	Voltage		kg
		24V = CC*	4298 01 01	0.052
		24V ~ CA**	4298 01 02	0.058
		110V ~ CA**	4298 02 01	0.051
		220V ~ CA**	4298 02 02	0.054
<p>*Direct current **Alternating current</p>				

4299 Pneumatic Button/Electro-Pneumatic

	<p>Nickel-plated brass</p> 	Contact		kg
		Standard*	4299 01 01	0.085
		With key*	4299 01 02	0.110
		Standard**	4299 02 01	0.102
		With key**	4299 02 02	0.124
<p>Bulkhead fixing hole diameter: Ø22 mm *1 pneumatic contact **1 electro-pneumatic contact Available upon request only</p>				

Industrial Blowguns

Polymer

Metal

Kits



PARKER LEGRIS Industrial Connector Systems

Products are available from

MARYLAND METRICS

P.O. Box 261 Owings Mills, MD 21117 USA email: sales@mdmetric.com

ph: (410)358-3130 (800)638-1830 fx: (410)358-3142 (800)872-9329

web: http://mdmetric.com RFQ form: http://mdmetric.com/rfq.htm

How to order: Please preface each PARKER LEGRIS Catalog part number with 'R053-' Example: R053-3175 04 10



Blowguns

Standard Blowgun (P. 7-7)



Fluids: compressed air
Materials: technical polymer, NBR
Pressure: 10 bar
Temperature: -15°C to +50°C
 DN : 3.5 mm

Safety Blowgun (P. 7-7)



Fluids: compressed air
Materials: technical polymer, NBR
Pressure: 10 bar
Temperature: -15°C to +50°C
 DN : 3 mm

Energy-Saving Blowgun (P. 7-7)



Fluids: compressed air
Materials: technical polymer, NBR
Pressure: 10 bar
Temperature: -15°C to +50°C
 DN : according to nozzle

Versatile Blowguns (P. 7-6)



Fluids: compressed air
Materials: technical polymer, NBR
Pressure: 10 bar
Temperature: -15°C to +50°C
 DN : according to nozzle

Metal Blowguns (P. 7-14)



Fluids: compressed air
Materials: forged nickel-plated brass, NBR
Pressure: 10 bar
Temperature: -15°C to +50°C
 DN : 2 mm

Water Pistol (P. 7-14)



Fluids: industrial fluids and water
Materials: zamak, NBR
Pressure: 20 bar
Temperature: -20°C to +100°C
 DN : 12 mm

Blowgun Kits (P. 7-16)



Fluids: compressed air
Materials: technical polymer
Pressure: 10 bar
Temperature: -15°C to +50°C
 DN : according to model

Nozzles (P. 7-10)



Fluids: compressed air
Materials: nickel-plated brass
Pressure: 10 bar
Temperature: -15°C to +50°C
 DN : according to model

Blowgun Range

Polymer Blowguns

Standard

0659
Page 7-7



Safety

0654
Page 7-7



Energy-Saving

0653
Lower Connection
Page 7-7



With Interchangeable Nozzle

0652
Lower Connection
Page 7-8



0655
Upper Connection
Page 7-8



Pre-Assembled with Nozzle

0651
Lower Connection
Page 7-8



0658
Upper Connection
Page 7-9



0656
Lower Connection
Page 7-9



0657
Upper Connection
Page 7-9



Nozzles for Polymer Blowguns

0690 01
Standard
Page 7-10



0690 02
Safety
Page 7-10



0690 03
Straight Tube (long)
Page 7-10



0690 04
Straight Tube (short), Safety
Page 7-10



0690 05
Angled Tube (long)
Page 7-10



0690 06
Angled Tube (short) Safety
Page 7-11



0690 06 01
Angled Tube (short)
Page 7-11



0690 07
LF 3000® Nozzle
Page 7-11



0690 08
Coanda
Page 7-11



0690 09
Air Screen
Page 7-11



0690 10
Booster
Page 7-12



0690 11
Booster with Air Screen
Page 7-12



Metal Blowguns

Button-Operated

0623
Page 7-15



Lever-Operated

0622
Page 7-15



Water Pistol

2299
Page 7-15



2299
Page 7-15



Blowgun Kits

0631..09
Standard
Page 7-17



0631..01
Safety
Page 7-17



0631..23
Energy-Saving
Page 7-17



0631..03
0631..02
Standard Nozzle
Page 7-17/18



0631..05
0631..04
Angled Nozzle, Safety
Page 7-18



0631..07
0631..06
Interchangeable Nozzle
Page 7-18/19



0631..08
Energy-Saving
Interchangeable Nozzle
Page 7-19



Polymer Blowguns

The Parker Legris polymer blowgun offers **ease of use**, **energy saving**, adaptability and efficiency. These blowguns comply with **international regulations** for health, **safety** and **noise** levels.

Product Advantages

Quality & Performance

- Comply with international standards for noise and pressure regulation
- Powerful flow with progressive control
- Rotating nozzle for directional jet
- Durable, shock-resistant materials
- 100% leak and flow-tested in production
- Date coding to guarantee quality and traceability

Safety & Sustainable Development

- 40% energy consumption reduction with Energy-Saving model
- Complete user safety with the Safety model
- Wide selection of nozzles which comply with noise and pressure level regulations

Ergonomics & Versatility

- Comfortable to use
- Lightweight and easy to use
- Wide range of models and nozzles for optimum blowing power and flow rate
- Lower or upper connection



Manufacturing Workshops

- Cleaning
- Blowing
- Mixing
- Ejection
- Cooling
- Packaging

Applications

Technical Characteristics

Compatible Fluids	Compressed air Other fluids: contact us
Working Pressure	0 to 10 bar
Working Temperature	Air: -15°C to +50°C Dry air: -20°C to +80°C
Tubes	Recoil tubes and hose

Regulations

Compliance for all blowguns:

- DI: 97/23/EC (PED)
- DI: 2002/95/EC (RoHS), 2011/65/EC
- DI: 1907/2006 (REACH)

Protection of design

All designs and models of Parker Legris blowguns have been registered with the following numbers: 13224 / 13225 / 13226.

Compliance for specific blowguns:

- DI: 1910.242 (b) [OSHA]
The static pressure must be less than 30 psi in case the nozzle becomes blocked.
- DI: 1910.95 (b) [OSHA]
The noise level must be less than 90 dBA over 8 hours' exposure.
- DI: 2003/10/EC
Regulation relating to exposure to noise, particularly with regard to risks to hearing. The noise level must be less than 87 dBA.


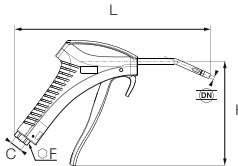


Component Materials



Silicone-free

Polymer Blowguns

0659 Standard Blowgun, Lower Connection with Short Angled Nozzle, Female BSP Thread

	Technical polymer, nickel-plated brass, treated aluminium, NBR 	C  	F H L kg
		G1/4 3.5 0659 00 13	20 120 223 0.072

Nozzle: aluminium, NPT version available.


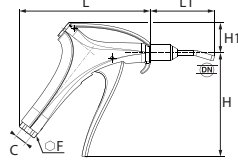


Progressive flow depending on the trigger position

Trigger position (mm)	Flow (Nl/min)
0	0
10	0
20	25
30	185
40	442
50	475

Pressure: 6 bar

- 475 Nl/min
- 82 dBA
- OSHA 1910.242 (b)
- OSHA 1910.95 (b)
- 2003/10/EC directive: Requirement to use ear protection if exposure > 8 hours

0654 Safety Blowgun, Lower Connection, Female BSP Thread

	Technical polymer, nickel-plated brass, NBR 	C  	F H H1 L L1 kg
		G1/4 3 0654 00 13	20 117 35 148 73 0.189

Nozzle: nickel-plated brass, NPT version available.


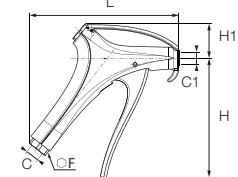

Progressive flow depending on the trigger position

Trigger position (mm)	Flow (Nl/min)
0	0
10	0
20	15
30	148
40	238
50	256

Pressure: 6 bar

- 250 Nl/min
- 80 dBA
- OSHA 1910.242 (b)
- OSHA 1910.95 (b)
- 2003/10/EC directive: No ear defenders necessary

0653 Energy-Saving Blowgun, Lower Connection with Interchangeable Nozzle, Female BSP Thread

	Technical polymer, nickel-plated brass, NBR 	C C1 	F H H1 L kg
		G1/4 M12x1.25 0653 66 13	20 117 34 147 0.144

Flow characteristics depend on the type of nozzle used. Delivered without nozzle. A value calculator for energy savings is available.

Progressive flow depending on the trigger position

Trigger position (mm)	Flow (Nl/min)
0	0
10	0
20	15
30	120
50	120

Pressure: 6 bar

- 120 Nl/min
- 80 dBA
- Noise level measured without nozzle
- OSHA 1910.242 (b)
- Depends on type of nozzle
- OSHA 1910.95 (b)
- 2003/10/EC directive: No ear defenders necessary

 Maximum Flow Rate (tolerance +/-10%)	 Noise Level ISO 15744	 Diffusion Cone	 Compliance with Standards
--	---	--	---

Operation: Safety Blowgun



Flow stopped completely and pressure reduced to 0.5 bar


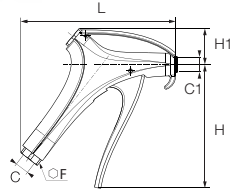

Operation: Blowgun with Safety Nozzle



Flow diverted and pressure reduced to 0.5 bar

Polymer Blowguns


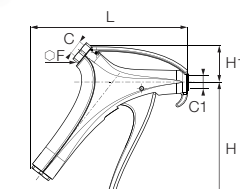

0652 Progressive Control Blowgun, Lower Connection with Interchangeable Nozzle, Female BSPP Thread

	Technical polymer, nickel-plated brass, NBR 	C C1 	F H H1 L kg
		G1/4 M12x1.25 0652 66 13	20 117 34 147 0.163

Flow characteristics depend on the type of nozzle used.
Delivered without nozzle.

- Depending on the type of nozzle
- 86 dBA Noise level measured without nozzle
- OSHA 1910.242 (b): Depends on type of nozzle
- OSHA 1910.95 (b) 2003/10/EC directive: Requirement to use ear protection if exposure > 8 hours


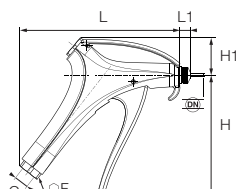


0655 Progressive Control Blowgun, Upper Connection with Interchangeable Nozzle, Female BSPP Thread

	Technical polymer, nickel-plated brass, NBR 	C C1 	F H H1 L kg
		G1/4 M12x1.25 0655 66 13	20 117 37 145 0.014

Flow characteristics depend on the type of nozzle used.
Delivered without nozzle.

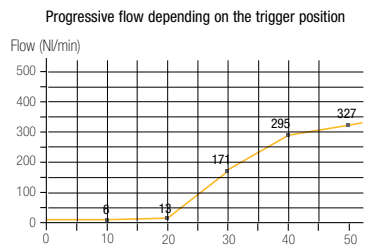
- Depending on the type of nozzle
- 86 dBA Noise level measured without nozzle
- OSHA 1910.242 (b): Depends on type of nozzle
- OSHA 1910.95 (b) 2003/10/EC directive: Requires ear defenders to be used when exposure is > 8 hours

0651 Progressive Control Blowgun, Lower Connection with Standard Nozzle, Female BSPP Thread

	Technical polymer, nickel-plated brass, NBR 	C  	F H H1 L L1 kg
		G1/4 2.5 0651 66 13	20 117 34 147 10 0.168

Nozzle: nickel-plated brass

Progressive flow depending on the trigger position




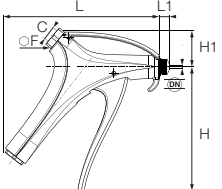


Trigger position (mm)	Flow (Nl/min)
0	0
6	6
18	18
30	171
40	295
50	327

Pressure: 6 bar

- 327 Nl/min Flow produced with nozzle **0690 01 00**
- 86 dBA
- OSHA 1910.95 (b) 2003/10/EC directive: Requirement to use ear protection if exposure > 8 hours

Polymer Blowguns

0658 Progressive Control Blowgun, Upper Connection with Standard Nozzle, Female BSPP Thread

	Technical polymer, nickel-plated brass, NBR 	C  	F H H1 L L1 kg
		G1/4 2.5 0658 66 13	20 117 37 145 10 0.195

Nozzle: nickel-plated brass

Progressive flow depending on the trigger position

Trigger position (mm)	0	10	20	30	40	50
Flow (Nl/min)	0	8	18	171	295	327


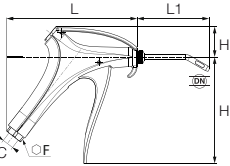


Pressure: 6 bar

327 Nl/min Flow produced with nozzle **0690 01 00**

86 dBA

OSHA 1910.95 (b)
2003/10/EC directive:
Requirement to use ear protection if exposure > 8 hours

0656 Safety Progressive Control Blowgun, Lower Connection with Short Angled Nozzle, Female BSPP

	Technical polymer, nickel-plated brass, NBR 	C  	F H H1 L L1 kg
		G1/4 2.5 0656 66 13	20 117 34 147 81 0.173

Nozzle: nickel-plated brass

Progressive flow depending on the trigger position

Trigger position (mm)	0	10	20	30	40	50
Flow (Nl/min)	0	8	18	171	358	524


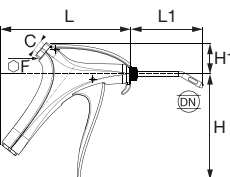


Pressure: 6 bar

524 Nl/min Flow produced with nozzle **0690 06 01**

86 dBA

OSHA 1910.242 (b)
OSHA 1910.95 (b)
2003/10/EC directive:
Requirement to use ear protection if exposure > 8 hours

0657 Safety Progressive Control Blowgun, Upper Connection with Short Angled Nozzle, Female BSPP

	Technical polymer, nickel-plated brass, NBR 	C  	F H H1 L L1 kg
		G1/4 2.5 0657 66 13	20 117 37 145 82 0.168

Nozzle: nickel-plated brass

Progressive flow depending on the trigger position

Trigger position (mm)	0	10	20	30	40	50
Flow (Nl/min)	0	8	18	171	358	524

Pressure: 6 bar


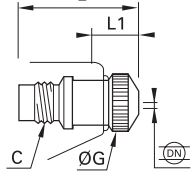






524 Nl/min Flow produced with nozzle **0690 06 01**

86 dBA


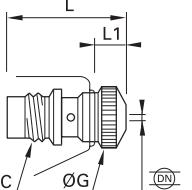






OSHA 1910.242 (b)
OSHA 1910.95 (b)
2003/10/EC directive:
Requirement to use ear protection if exposure > 8 hours

Nozzles for Polymer Blowguns


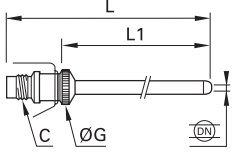






0690 01 Standard Nozzle

	<p>Nickel-plated brass</p> 	<p>C  </p>	G	L	L1	kg
		<p>M12x1.25 2.5 0690 01 00</p>  <p>327 NI/min  86 dBA  23°</p> <ul style="list-style-type: none"> Versatile use Progressive and powerful air jet <p> OSHA 1910.95 (b) 2003/10/EC directive: Requirement to use ear protection if exposure > 8 hours</p>	15	31	9	0.024


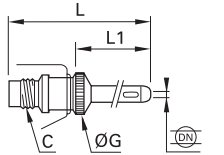






0690 02 Safety Nozzle

	<p>Nickel-plated brass</p> 	<p>C  </p>	G	L	L1	kg
		<p>M12x1.25 2.5 0690 02 00</p>  <p>315 NI/min  83 dBA  26°</p> <ul style="list-style-type: none"> Fluidised Powders Air screen effect Safety: avoids the nozzle becoming completely blocked <p> OSHA 1910.95 (b)/1910.242 (b) 2003/10/EC directive: Requirement to use ear protection if exposure > 8 hours</p>	15	31	9	0.024


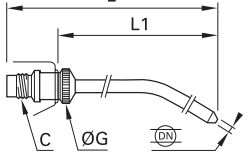






0690 03 Straight Nozzle (Long)

	<p>Nickel-plated brass</p> 	<p>C  </p>	G	L	L1	kg
		<p>M12x1.25 2.5 0690 03 00</p>  <p>386 NI/min  82 dBA  21°</p> <ul style="list-style-type: none"> Restricted Access Progressive and powerful air jet <p> OSHA 1910.95 (b) 2003/10/EC directive: Requirement to use ear protection if exposure > 8 hours</p>	15	332	307	0.068

0690 04 Safety Straight Nozzle (Short)

	<p>Nickel-plated brass</p> 	<p>C  </p>	G	L	L1	kg
		<p>M12x1.25 2.5 0690 04 00</p>  <p>410 NI/min  82 dBA  21°</p> <ul style="list-style-type: none"> Restricted Access Air screen effect and directional jet Safety: avoids the nozzle becoming completely blocked <p> OSHA 1910.242 (b)/ OSHA 1910.95 (b) 2003/10/EC directive: Requirement to use ear protection if exposure > 8 hours</p>	15	102	77	0.033

0690 05 Angled Nozzle (Long)

	<p>Nickel-plated brass</p> 	<p>C  </p>	G	L	L1	kg
		<p>M12x1.25 2.5 0690 05 00</p>  <p>354 NI/min  82 dBA  21°</p> <ul style="list-style-type: none"> Restricted or distant access Progressive and powerful air jet 360° rotation <p> OSHA 1910.95 (b) 2003/10/EC directive: Requirement to use ear protection if exposure > 8 hours</p>	15	316	292	0.065

Nozzles for Polymer Blowguns

0690 06 Safety Angled Nozzle (Short)

	Nickel-plated brass		C	G L L1 kg
			M12x1.25 2.5 0690 06 00	15 94 70 0.033
			<ul style="list-style-type: none"> Restricted Access Air screen effect and 360° directional jet Safety: avoids the nozzle becoming completely blocked 	

0690 06 01 Angled Nozzle (Short)

	Nickel-plated brass		C	G L L1 kg
			M12x1.25 2.5 0690 06 01	15 94 70 0.033
			<ul style="list-style-type: none"> Difficult access Progressive and powerful air jet, 360° rotation 	

0690 07 Nozzle with LF 3000® Push-In Connection

	Nickel-plated brass		ØD C	G L L1 kg
			4 M12x1.25 0690 07 00	15 35 13 0.024
			<ul style="list-style-type: none"> Restricted Access Progressive air jet 	

0690 09 Air Screen Safety Nozzle


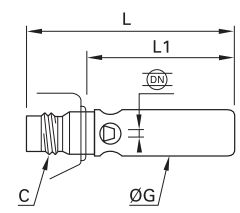


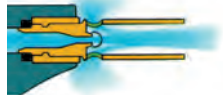




	Nickel-plated brass		C	G L L1 kg
			M12x1.25 2 0690 09 00	30 40.5 18.5 0.021
			<ul style="list-style-type: none"> High flow for blowing large surfaces Air screen and deflector to avoid particles being blown back Safety: avoids the nozzle becoming completely blocked 	

0690 08 COANDA Nozzle


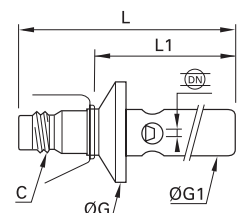





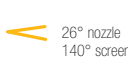

	Nickel-plated brass		C	L L1 kg
			M12x1.25 0690 08 00	47.5 26 0.033
			<ul style="list-style-type: none"> Directional air jet Very quiet, energy-saving Safety: avoids the nozzle becoming completely blocked 	

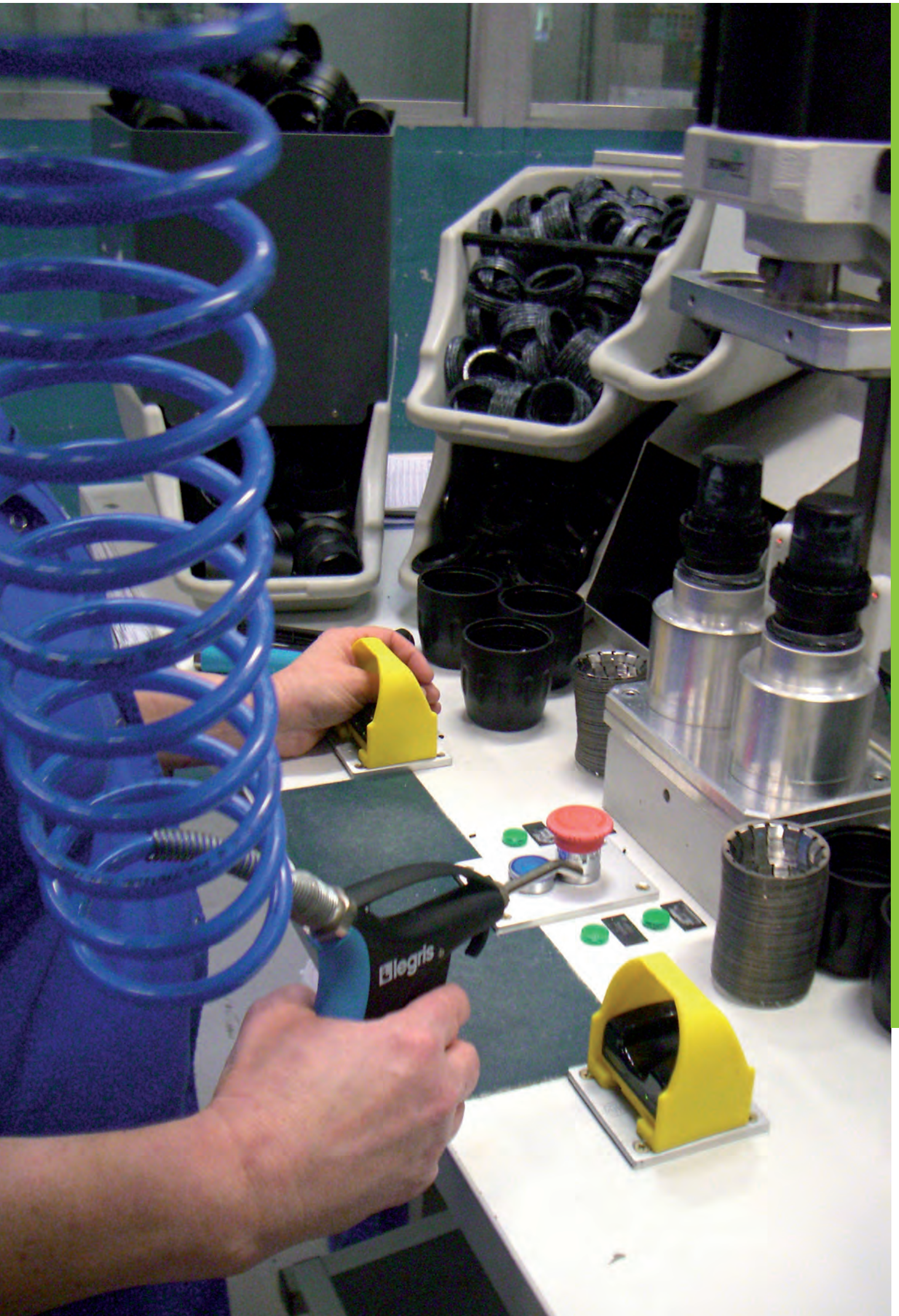
Nozzles for Polymer Blowguns

0690 10 Safety Booster Nozzle

	<p>Nickel-plated brass</p> 	<p>C  </p>	<p>G L L1 kg</p>			
			<p>M12x1.25 2.5 0690 10 00</p>			15
			<ul style="list-style-type: none"> • High flow for blowing large surfaces • Air screen effect • Safety: avoids the nozzle becoming completely blocked 			
		 780 NI/min	 99 dBA	 28°	 OSHA 1910.242 (b) 2003/10/EC directive: Requires ear defenders to be used at all times	

0690 11 Safety Booster Nozzle with Air Screen

	<p>Nickel-plated brass</p> 	<p>C  </p>	<p>G G1 L L1 kg</p>				
			<p>M12x1.25 2.5 0690 11 00</p>			30	15
		<p>Deflector: technical polymer</p> 	<ul style="list-style-type: none"> • Same advantage as the Booster nozzle • Safety: avoids the nozzle becoming completely blocked • Air screen and deflector avoid particles being blown back 				
		 860 NI/min	 99 dBA	 26° nozzle 140° screen	 OSHA 1910.242 (b) 2003/10/EC directive: Requires ear defenders to be used at all times		



Metal Blowguns and Water Pistols

This range of robust blowguns guarantees a **longer service life** under **severe conditions** (crushing, impact, shock and corrosion). It includes two versions **to meet all requirements** for blowing and spraying in industrial applications.

Product Advantages

- Workshop Blowgun** | Compact for easy incorporation into compressed air ring mains
Nickel-plated forged brass for increased corrosion resistance
- Water Pistol** | Intended for the transmission of water and fluids
Designed for precise flow control and optimisation of the power and shape of the jet
Optimum use of industrial fluids
Excellent ergonomics and service life



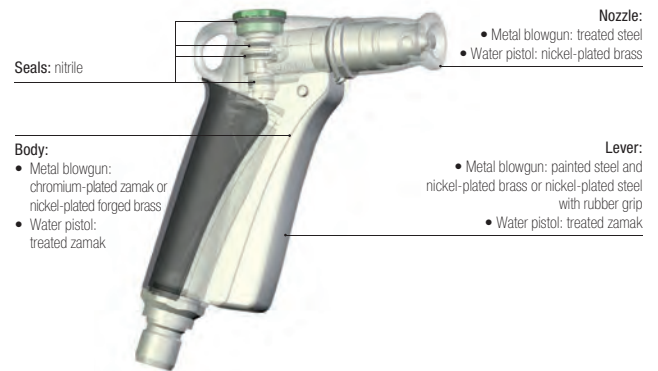
- Manufacturing Workshops
- Assembly machines
- Robotics
- Ejection
- Cooling
- Packaging
- Automotive Process

Applications

Technical Characteristics

Model	Metal Blowgun	Water Pistol
Compatible Fluids	Compressed air, industrial fluids	Water, oil, industrial fluids
Working Pressure	0 to 10 bar	0 to 20 bar
Working Temperature	Air: -15°C to +50°C Dry air: -20°C to +80°C	-20°C to +100°C
Tubes	Recoil tubes and hose	Braided hose with Parker Legris couplers

Component Materials




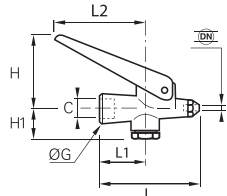


Silicone-free

Regulations


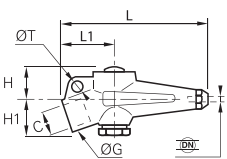


Compliance for all blowguns:
 DI: 97/23/EC (PED)
 DI: 2002/95/EC (RoHS), 2011/65/EC
 DI: 1907/2006 (REACH)

Metal Blowguns and Water Pistols


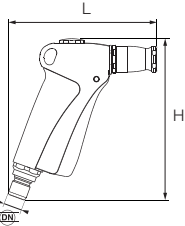



0623 Lever-Operated Blowgun, Female BSPP Thread

	Nickel-plated brass, NBR 	C  	G	H min	H max	H1	L	L1	L2	kg
		G1/4 2 0623 10 35	18	19	37	21	64	28	60	0.119
This blowgun has a hardened steel nozzle.										


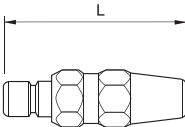

0622 Button-Operated Blowgun, Female BSPP Thread

	Nickel-plated brass, NBR 	C  	G	H	H1	L	L1	ØT	kg	
		G1/4 2 0622 26 73	18	17.5	20.5	82	29	7	0.196	
This blowgun has a hardened steel nozzle.										

2299 Water Pistol

	Zamak, nickel-plated brass, NBR 		H	L	kg
		12 2299 12 01	140	126	0.471
This pistol allows independent control of: - the flow rate (trigger) - type of jet (adjustable to a fine mist) by the adjustable nozzle					
		 1440 NI/min (air) 16.2 NI/min (water)	 Adjustable		

2299 Adjustable Nozzle

	Nickel-plated brass, NBR 		L	kg
		12 2299 12 20	77.4	0.137
This nozzle allows adjustment of the spray.				

Associated Products

For optimum connection and usage of the pistol and adjustable nozzle, you will find a full range of quick-acting couplers, in the Midi and Maxi Series, in Chapter 8.

Midi P. 8-43



Maxi P. 8-46



Blowgun Kits

Ready for use, **simple** and **ergonomic**, the Parker Legris blowgun kit remains an essential item of equipment for any blowing or spraying operation in the industrial environment.

Product Advantages

Ready for Use

- Kit contents:
- one blowgun
 - a 4 metre recoil tube
 - one R1/4 threaded fitting, external diameter 8 mm

Easy to install and comfortable to use
 Wide range of models and nozzles for optimum flow
 Lower or upper connection
 Labelling and colours can be customised
 Packaging designed to facilitate self-service sales

Safety & Performance

Safe operation with the Safety or OSHA models
 Durable, shock-resistant materials
 100% leak and flow-tested in production
 Date coding to guarantee quality and traceability
 Minimum pressure drop
 Optimisation of your energy consumption with the Energy-Saving model



Manufacturing Workshops
 Cleaning
 Blowing
 Mixing
 Ejection
 Cooling
 Packaging

Applications

Technical Characteristics

Compatible Fluids	Compressed air Other fluids: contact us
Working Pressure	0 to 10 bar
Working Temperature	Air: -15°C to +50°C Dry air: -20°C to +80°C
Tubes	Recoil tubing

Regulations

Compliance for all blowguns:
 DI: 97/23/EC (PED)
 DI: 2002/95/EC (RoHS), 2011/65/EC
 DI: 1907/2006 (REACH)

Protection of design
 All designs and models of Parker Legris blowguns have been registered with the following numbers:
 13224 / 13225 / 13226.

Compliance for specific blowguns:
 DI: 1910.242 (b) [OSHA]
 The static pressure must be less than 30 psi in case the nozzle becomes blocked.
 DI: 1910.95 (b) [OSHA]
 The noise level must be less than 90 dBA over 8 hours' exposure.
 DI: 2003/10/EC
 Regulation relating to exposure to noise, particularly with regard to risks to hearing. The noise level must be less than 87 dBA.

Component Materials



Silicone-free


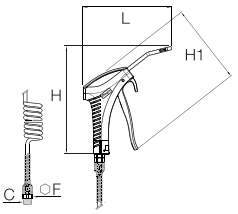

Customisation on request

- Marking
- Kit contents adaptable to your applications
- Additional functions
- Colour


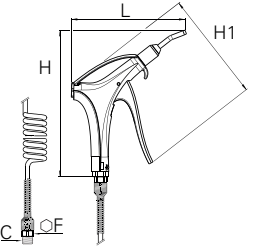



Blowgun Kits


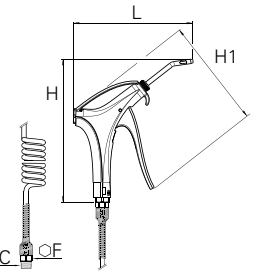

0631..09 Blowgun Kit, Lower Connection, Male BSPT Thread

	Technical polymer, nickel-plated brass, treated aluminium, NBR, polyurethane tubing 	C		F	H	H1	L	kg
		R1/4	0631 00 09	16	192.5	139.5	152	0.441
Flow characteristics, noise level and norm compliance are identical to those of our blowguns (0659 00 13).								


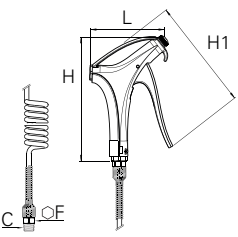

0631..01 Safety Blowgun Kit, Lower Connection, Male BSPT Thread

	Technical polymer, nickel-plated brass, NBR, polyurethane tubing 	C		F	H	H1	L	kg
		R1/4	0631 00 01	16	198.5	148.5	154	0.576
Flow characteristics, noise level and norm compliance are identical to those of our blowguns (0654 00 13).								

0631..23 Energy Saving Blowgun Kit with Angled Nozzle, Male BSPT Thread


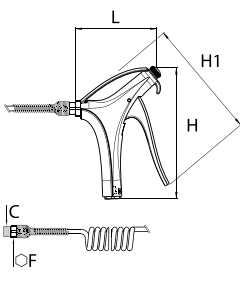

	Technical polymer, nickel-plated brass, NBR, polyurethane tubing 	C		F	H	H1	L	kg
		R1/4	0631 00 23	16	195	148.5	154	0.456
Flow characteristics, noise level and norm compliance are identical to those of our blowguns (0653 66 13). External diameter of tube 6 mm								

0631..03 Blowgun Kit, Lower Connection with Standard Nozzle, Male BSPT Thread


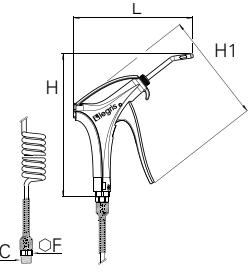

	Technical polymer, nickel-plated brass, NBR, polyurethane tubing 	C		F	H	H1	L	kg
		R1/4	0631 00 03	16	165	148.5	99	0.528
Flow characteristics, noise level and norm compliance are identical to those of our blowguns (0651 66 13).								

Blowgun Kits


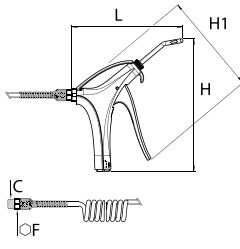

0631..02 Blowgun Kit, Upper Connection with Standard Nozzle, Male BSPT Thread

	Technical polymer, nickel-plated brass, NBR, polyurethane tubing 	C 	F	H	H1	L	kg
		R1/4 0631 00 02	16	163	148.5	101	0.524
Flow characteristics, noise level and norm compliance are identical to those of our blowguns (0658 66 13).							


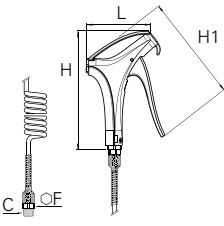

0631..05 Blowgun Kit Lower Connection with Short Angled Nozzle, Male BSPT Thread

	Technical polymer, nickel-plated brass, NBR, polyurethane tubing 	C 	F	H	H1	L	kg
		R1/4 0631 00 05	16	195,5	148,5	163	0,536
Flow characteristics, noise level and norm compliance are identical to those of our blowguns (0656 66 13).							

0631..04 Blowgun Kit, Lower Connection with Short Angled Nozzle, Male BSPT Thread


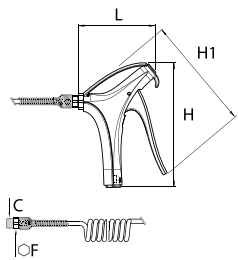

	Technical polymer, nickel-plated brass, NBR, polyurethane tubing 	C 	F	H	H1	L	kg
		R1/4 0631 00 04	16	195	148.5	163.5	0.617
Flow characteristics, noise level and norm compliance are identical to those of our blowguns (0657 66 13).							

0631..07 Blowgun Kit, Lower Connection with Interchangeable Nozzle, Male BSPT Thread

	Technical polymer, nickel-plated brass, NBR, polyurethane tubing 	C 	F	H	H1	L	kg
		R1/4 0631 00 07	16	163	148.5	91	0.617
Flow characteristics, noise level and norm compliance are identical to those of our blowguns (0656 66 13). Delivered without nozzle.							


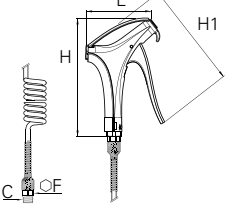

Blowgun Kits

0631..06 Blowgun Kit, Upper Connection with Interchangeable Nozzle, Male BSPT Thread

	<p>Technical polymer, nickel-plated brass, NBR, polyurethane tubing</p> 	<p>C </p>	F	H	H1	L	kg
		<p>R1/4 0631 00 06</p>	16	161.5	148.5	93	0.501

Flow characteristics, noise level and norm compliance are identical to those of our blowguns (0655 66 13).
Delivered without nozzle.

0631..08 Energy Saving Blowgun Kit, Lower Connection, Interchangeable Nozzle, Male BSPT Thread

	<p>Technical polymer, nickel-plated brass, NBR, polyurethane tubing</p> 	<p>C </p>	F	H	H1	L	kg
		<p>R1/4 0631 00 08</p>	16	163	148.5	91	0.496

Flow characteristics, noise level and norm compliance are identical to those of our blowguns (0655 66 13).
Delivered without nozzle.

Quick-Acting Couplers

Polymer Safety, C 9000

Metal: Nickel-Plated Brass and Stainless Steel



PARKER LEGRIS Industrial Connector Systems

Products are available from:

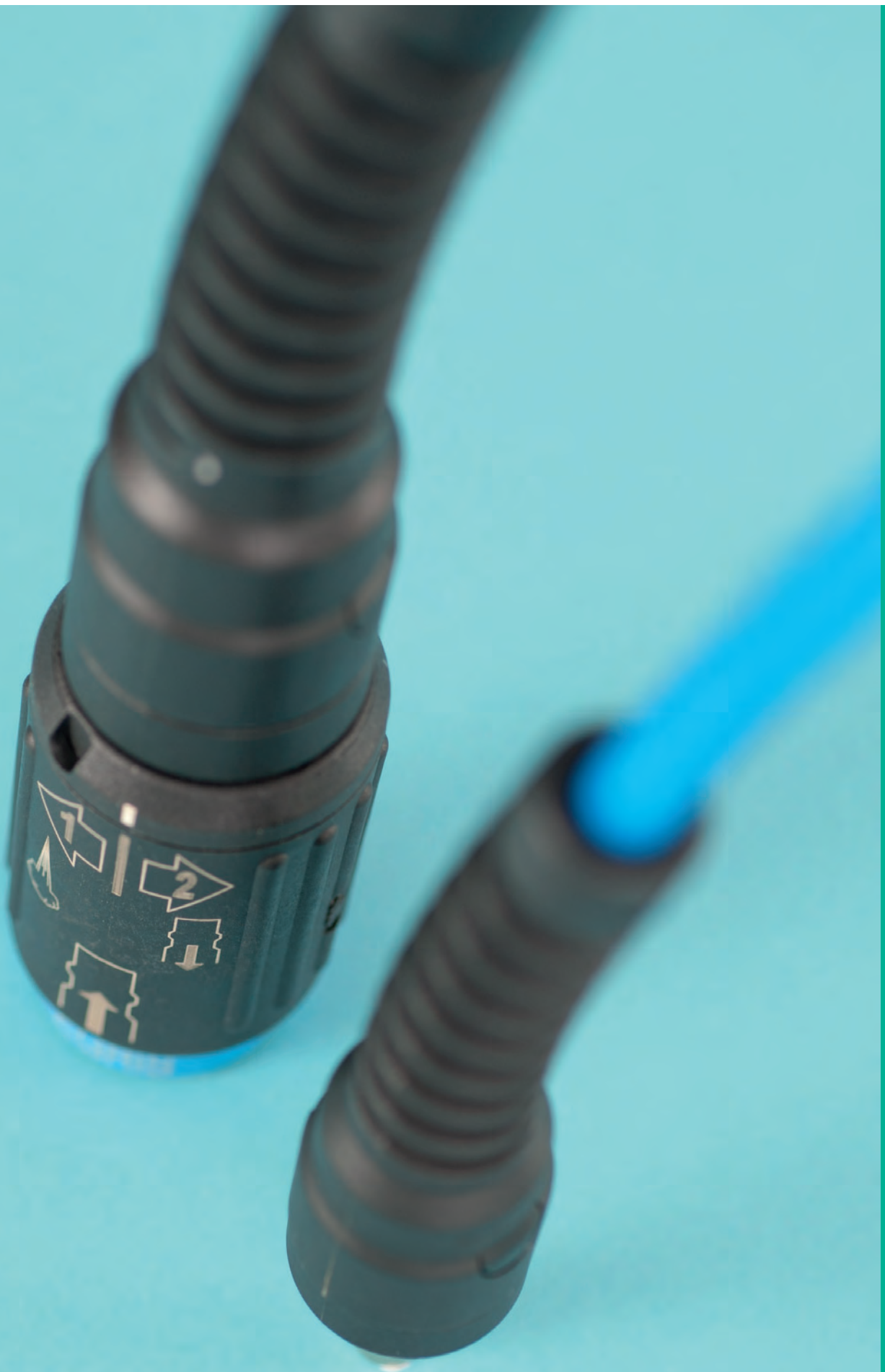
MARYLAND METRICS

P.O. Box 261 Owings Mills, MD 21117 USA email: sales@mdmetric.com

ph: (410)358-3130 (800)638-1830 fx: (410)358-3142 (800)872-9329

web: http://mdmetric.com RFQ form: http://mdmetric.com/rfq.htm

How to order: Please preface each PARKER LEGRIS Catalog part number with 'R053-' Example: R053-3175 04 10



Quick-Acting Couplers

C 9000 Polymer Quick-Acting Safety Couplers (P. 8-7)



Fluids: compressed air

Materials: reinforced technical polymer, nickel-plated brass

Pressure: 16 bar

Temperature: -20°C to +60°C

DN : 5.5 mm to 8 mm

Metal Quick-Acting Couplers (P. 8-18)



Fluids: compressed air, water, industrial fluids

Materials: nickel-plated brass or stainless steel

Pressure: 35 bar (stainless steel), 20 bar (brass)

Temperature: -15°C to +200°C (stainless steel), -20°C to +100°C (brass)

DN : 2 mm to 19 mm

Metal Quick-Acting Mould Couplers (P. 8-50)



Fluids: heat transfer fluids

Materials: nickel-plated brass

Pressure: 10 bar

Temperature: -15°C to +90°C

DN : 8 mm to 12 mm

3 Shut-Off Functions

Straight-Through

These couplers work without shut-off, meaning they offer maximum flow. Straight-Through couplers are designed to carry fluids such as water, coolants, etc. Before disconnection, the fluid flow must be shut off using a valve located upstream of the coupler.



Single Shut-Off (with or without vent)

On our single shut-off couplers, the male probe is straight-through. The fluid flow can be stopped in the female coupler when disconnected. The circuit can be vented upstream to avoid any risk of whiplash.



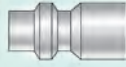

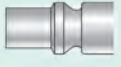




Double Shut-Off

On our double shut-off couplers, after disconnection, flow is prevented both upstream of the female coupler and downstream of the probe. Both sides of the circuit remain under pressure.



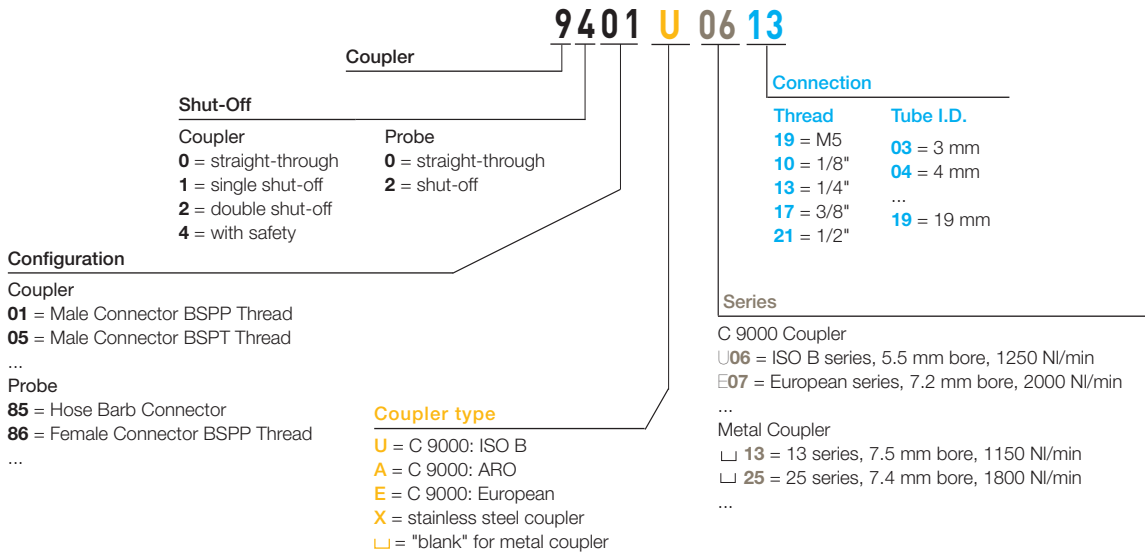
Technology and Flow Rates

The profiles of the Parker Legris quick-acting couplers are manufactured to conform to international standards and are interchangeable with other manufacturers' products meeting these standards.

Profile Description	Profile	Interchangeability	Flow (NI/min)	Bore Diameter (mm)
ISO B Standard		C 9000 Rectus 23 Rectus 24	1250 900 550	5.5
		C 9000 Rectus 30	2400 890	8 8.5
European Standard		C 9000 Rectus 26 Rectus 25	2000 1000 1800	7.2 7.2 7.4
		Rectus 27	2400	10
ARO Standard		C 9000 Rectus 14 Rectus 22	1250 560 800	5.5
ISO C Standard		Rectus 18	970	5.5
Asian Standard		Rectus 13	1150	7.5
UK Standard		Rectus 17	870	5
		Rectus 19	660	5.5
German Standard		Rectus 20	165	2.7
		Rectus 21	560	5

Quick-Acting Coupler Part Numbers

Standard Product



C 9000 Polymer Quick-Acting Safety Coupler Range

C 9000 Polymer Quick-Acting Safety Couplers

ISO B Profile

9401U Page 8-10 **9405U** Page 8-10 **9414U** Page 8-10 **9410U** Page 8-10 **9421U** Page 8-10 **9416U** Page 8-11 **9440U** Page 8-11



9087U Page 8-11 **9086U** Page 8-11 **9080U** Page 8-12 **9094U** Page 8-12



European Profile

9401E Page 8-13 **9414E** Page 8-13 **9410E** Page 8-13 **9421E** Page 8-13 **9416E** Page 8-13 **9440E** Page 8-14



9087E Page 8-14 **9086E** Page 8-14 **9080E** Page 8-14 **9094E** Page 8-14



ARO Profile

9401A Page 8-15 **9405A** Page 8-15 **9414A** Page 8-15 **9410A** Page 8-15 **9421A** Page 8-15 **9416A** Page 8-16 **9440A** Page 8-16



9087A Page 8-16 **9086A** Page 8-16 **9084A** Page 8-16 **9080A** Page 8-17 **9094A** Page 8-17



C 9000 Polymer Quick-Acting Safety Couplers

This range of ergonomic polymer couplers has been designed for **the safety of operators and machinery** while giving very high **energy efficiency performance**. Available in three profile standards, it is perfectly suited for any type of installation.

Product Advantages

Safety & Reliability

- Prevents risk of whiplash
- Quick-acting vent allowing disconnection to be carried out in total safety
- Rotating sleeve to avoid risk of accidental disconnection
- Low connection/disconnection force even under pressure
- Polymer sleeve protects equipment from scratching
- Protective spiral over the tube prevents kinking

Performance

- Very high flow and low pressure drop
- 100% leak-tested in production
- Date coding to guarantee quality and traceability
- Robust impact-resistant material
- Optimum energy efficiency
- Long-term reliability

Easy-to-Use

- Immediate identification by clear marking on each model showing:
 - profile of the compatible male probe
 - type part number
- Compatible with male probes conforming to:
 - ISO B profile
 - European profile
 - ARO profile



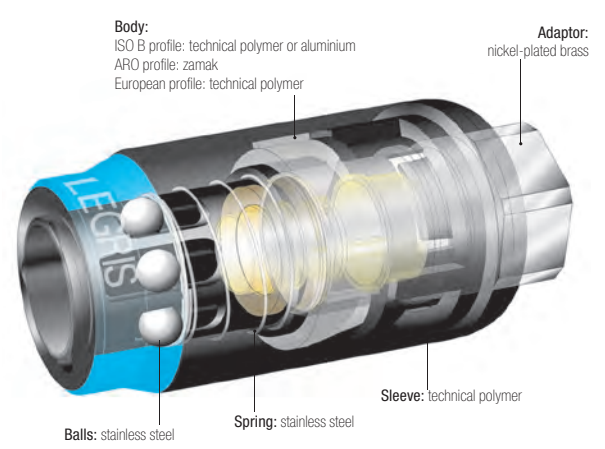
Applications

- Workshops
- Cleaning
- Blowing
- Pneumatics
- Air-Operated Tools
- Ring Main Circuits
- Packaging

Technical Characteristics

Compatible Fluids	Compressed air
Working Pressure	0 to 16 bar
Working Temperature	-20°C to +60°C

Component Materials



Silicone-free

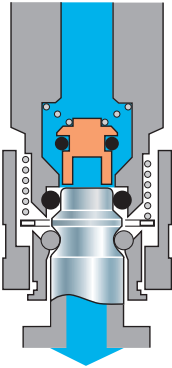
Regulations

- DI: 97/23/EC (PED)
- DI: 2002/95/EC (RoHS), 2011/65/EC
- DI: 1907/2006 (REACH)
- ISO 4414 Pneumatic Fluid Power: General Rules Relating to Systems
- DIN EN 983 Safety Standard for Pneumatics

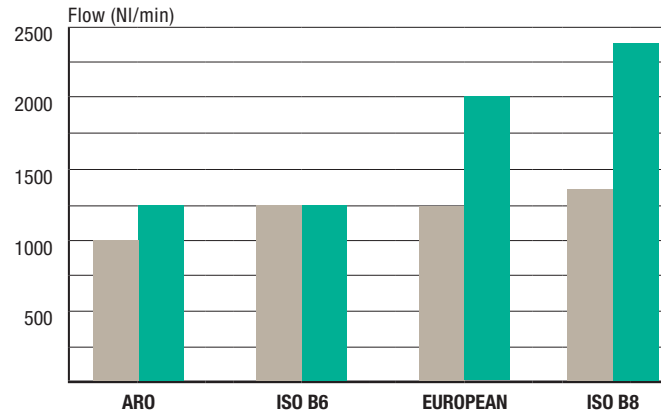
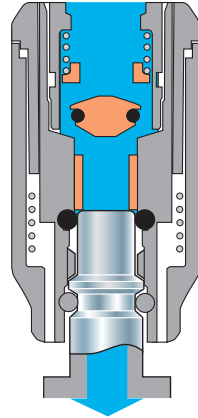
C 9000 Polymer Quick-Acting Safety Couplers

C 9000 Technology and Flow Rates

"Typical" quick-acting coupler
Standard "poppet" technology
Flow: 1400 NI/min



C 9000 quick-acting coupler
"Optimal flow" technology
Flow: 2400 NI/min

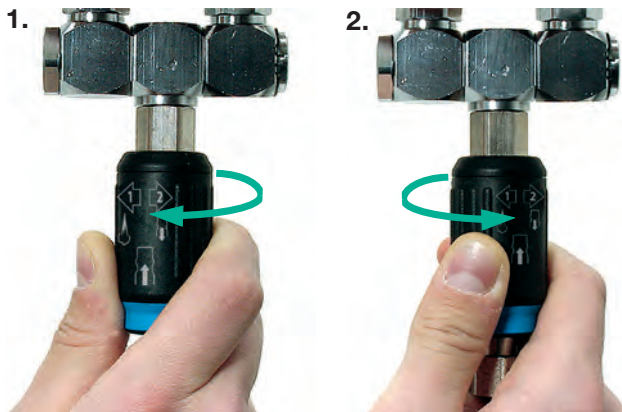


C 9000 Coupler
 Standard Couplers

Measurements carried out in accordance with ISO 6358 at a pressure of 6 bar, pressure drop < 0.7 bar

Operation

Operation



Disconnecting the probe

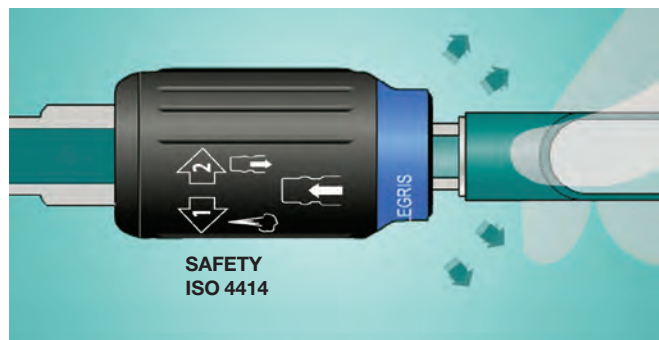
Rotation, arrow 1: circuit vented on probe side.

Rotation, arrow 2: probe disconnected from the body.

Connecting the probe

The sleeve does not need to be rotated to connect the probe.

Venting



ISO B6 profile, recoil tubing (I.D. 6 mm, length 6 m)

Venting time = 350 ms (transition from 6 bar to 0.2 bar)

ISO B8 profile, PVC tubing (I.D. 10 mm, length 25 m)


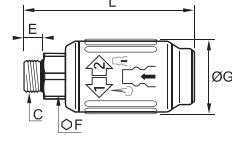

Venting time = 860 ms (transition from 6 bar to 0.2 bar)

Even with longer lengths of tubing, the vent time of the C 9000 coupler can be less than 1 second.


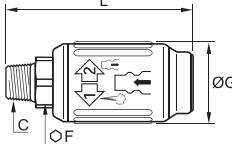

ISO B Profile




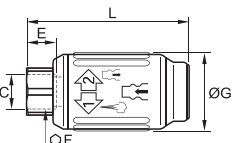

9401U Coupler, Male BSPP Thread

	Technical polymer, nickel-plated brass, NBR 	(DN) C 	E	F	G	L	kg		
			G1/4	9401U06 13	7.5	17	31.5	74	0.075
		5.5	G3/8	9401U06 17	8.5	21	31.5	76.5	0.095
			G1/2	9401U06 21	10.5	25	31.5	80	0.115
		8	G1/4	9401U08 13	6.5	22	36.5	81.5	0.120
			G3/8	9401U08 17	7.5	22	36.5	82.5	0.133
	G1/2	9401U08 21	9	25	36.5	85.5	0.140		
C 9000 Series ISO B (DN 5.5): single shut-off = 1250 NI/min C 9000 Series ISO B (DN 8): single shut-off = 2400 NI/min									


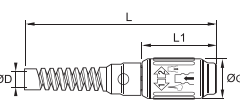

9405U Coupler, Male BSPT Thread

	Technical polymer, nickel-plated brass, NBR 	(DN) C 	F	G	L	kg		
			R1/4	9405U06 13	17	31.5	75	0.075
		5.5	R3/8	9405U06 17	19	31.5	76.5	0.095
			R1/2	9405U06 21	22	31.5	81.5	0.110
		8	R1/4	9405U08 13	22	36.5	84	0.120
			R3/8	9405U08 17	22	36.5	84	0.120
	R1/2	9405U08 21	22	36.5	88	0.140		
C 9000 Series ISO B (DN 5.5): single shut-off = 1250 NI/min C 9000 Series ISO B (DN 8): single shut-off = 2400 NI/min								


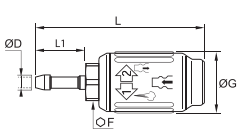

9414U Coupler, Female BSPP Thread

	Technical polymer, nickel-plated brass, NBR 	(DN) C 	E	F	G	L	kg		
			G1/4	9414U06 13	12	17	31.5	66.5	0.070
		5.5	G3/8	9414U06 17	12	22	31.5	72	0.085
			G1/2	9414U06 21	15	27	31.5	78	0.115
		8	G1/4	9414U08 13	12	22	36.5	75	0.127
			G3/8	9414U08 17	12	22	36.5	75	0.144
	G1/2	9414U08 21	15	27	36.5	80	0.138		
C 9000 Series ISO B (DN 5.5): single shut-off = 1250 NI/min C 9000 Series ISO B (DN 8): single shut-off = 2400 NI/min									

9410U Coupler, LF 3000® Push-In Connection, Body Spiral Protection Spring

	Technical polymer, nickel-plated brass, NBR 	(DN) ØD 	G	L	L1	kg		
			5.5	8	9410U06 08	31.5	145	56
			10	9410U06 10	31.5	145	56	0.080
		8	10	9410U08 10	36.5	155	63	0.175
			12	9410U08 12	36.5	165	63	0.162
		C 9000 Series ISO B (DN 5.5): single shut-off = 1250 NI/min C 9000 Series ISO B (DN 8): single shut-off = 2400 NI/min						


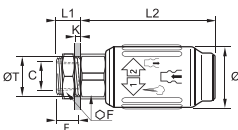


9421U Coupler with Hosetail

	Technical polymer, nickel-plated brass, NBR 	(DN) ØD 	F	G	L	L1	kg		
			5.5	6	9421U06 06	17	31.5	88.5	26
			8	9421U06 08	17	31.5	88.5	26	0.070
			10	9421U06 10	17	31.5	88.5	26	0.070
		8	6	9421U08 06	22	36.5	95	26	0.110
			8	9421U08 08	22	36.5	95	26	0.100
			10	9421U08 10	22	36.5	95	26	0.124
			13	9421U08 13	22	36.5	99	30	0.125
		C 9000 Series ISO B (DN 5.5): single shut-off flow = 1250 NI/min C 9000 Series ISO B (DN 8): single shut-off flow = 2400 NI/min							

ISO B Profile


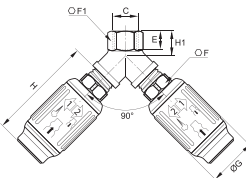




9416U Coupler, Bulkhead Mountable, Female BSPP Thread

	Technical polymer, nickel-plated brass, NBR 	 C		E	F	G	K_{max}	L1	L2	ØT_{min}	kg	
		5.5	G1/4	9416U06 13	12	22	31.5	6	12.5	68.5	18.5	0.105
		8	G3/8	9416U08 17	12	24	36.5	7	14.5	76	22.5	0.150


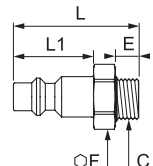


C 9000 Series ISO B (DN 5.5): single shut-off = 1250 NI/min
C 9000 Series ISO B (DN 8): single shut-off = 2400 NI/min

9440U Y Coupler, Female BSPP Thread

	Technical polymer, nickel-plated brass, NBR 	 C		E	F	F1	G	H	H1	kg	
		5.5	G3/8	9440U06 17	11.5	19	20	31.5	70	16	0.207
		8	G1/2	9440U08 21	14	22	25	36.5	80	19	0.352


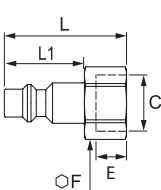


C 9000 Series ISO B (DN 5.5): single shut-off = 1250 NI/min
C 9000 Series ISO B (DN 8): single shut-off = 2400 NI/min

9087U Probe, Straight-Through, Male BSPP Thread

	Nickel-plated steel, technical polymer 	 C		E	F	L	L1	kg	
		5.5	G1/4	9087U06 13	9	17	38	24	0.025
			G3/8	9087U06 17	9	19	38	24	0.032
			G1/2	9087U06 21	12	22	42	24	0.048
		8	G1/4	9087U08 13	9	17	38	24	0.030
			G3/8	9087U08 17	9	19	39	24	0.036
	G1/2	9087U08 21	12	22	42	24	0.058		


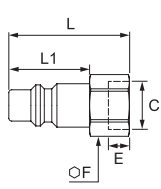


Probe without shut-off

9086U Probe, Straight-Through, Female BSPP Thread

	Nickel-plated steel 	 C		E	F	L	L1	kg	
		5.5	G1/4	9086 23 13	9	17	36	24	0.025
			G3/8	9086 23 17	9	19	36	24	0.025
			G1/2	9086 23 21	12	24	39	24	0.039

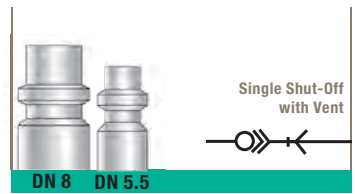
Probe without shut-off

9086U Probe, Straight-Through, Female BSPP Thread


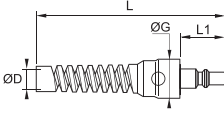



	Nickel-plated steel 	 C		E	F	L	L1	kg	
		8.5	G1/4	9086 30 13	10	17	40	28	0.032
			G3/8	9086 30 17	10	19	42	28	0.035
			G1/2	9086 30 21	12	24	43	28	0.046

Probe without shut-off
30 Series probe (DN 8.5) compatible with ISO B series C 9000 couplers (DN 8)

ISO B Profile


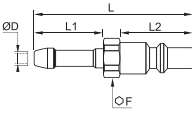





9080U Probe, Straight-Through, LF 3000® Push-In Connection, with Spiral Protection Spring

	Nickel-plated steel, NBR 				G	L	L1	kg
		5.5	8	9080U06 08	24	112	24	0.052
			10	9080U06 10	24	112	24	0.044
			10	9080U08 10	24	114	26	0.095
		8	12	9080U08 12	29.5	125	26	0.096

Probe without shut-off

9094U Probe, Straight-Through, with Hosetail


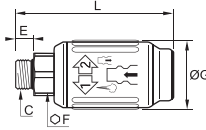


	Nickel-plated steel 				F	L	L1	L2	kg
			6	9094U06 06	14	51	24	25	0.016
		5.5	8	9094U06 08	14	51	27	25	0.017
			10	9094U06 10	14	51	24	25	0.018
			8	9094U08 08	17	51	24	25	0.027
		8	10	9094U08 10	17	51	27	25	0.028
	13	9094U08 13	17	51	24	25	0.031		

Probe without shut-off


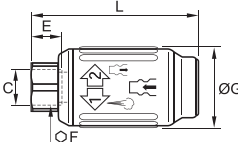


European Profile




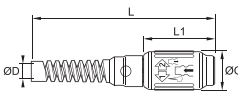


9401E Coupler, Male BSPP Thread

	Technical polymer, nickel-plated brass, NBR 	 C 	E	F	G	L	kg	
		G1/4	9401E07 13	6.5	22	36.5	80	0.124
		7.2 G3/8	9401E07 17	7.5	22	36.5	81	0.122
		G1/2	9401E07 21	9	25	36.5	83.5	0.136
C 9000 Series: single shut-off = 2000 NI/min								


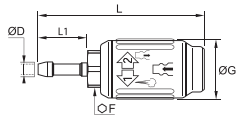


9414E Coupler, Female BSPP Thread

	Technical polymer, nickel-plated brass, NBR 	 C 	E	F	G	L	kg	
		G1/4	9414E07 13	12	22	36.5	73	0.118
		7.2 G3/8	9414E07 17	12	22	36.5	73	0.109
		G1/2	9414E07 21	15	27	36.5	78	0.130
C 9000 Series: single shut-off = 2000 NI/min								


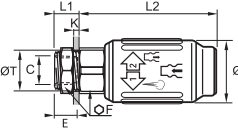


9410E Coupler, LF 3000® Push-In Connection, with Spiral Protection Spring

	Technical polymer, nickel-plated brass, NBR 	 ØD 	G	L	L1	kg	
		10	9410E07 10	36.5	151	63	0.175
		7.2 12	9410E07 12	36.5	151	63	0.180
C 9000 Series: single shut-off = 2000 NI/min							

9421E Coupler with Hosetail

	Technical polymer, nickel-plated brass, NBR 	 ØD 	F	G	L	L1	kg	
		8	9421E07 08	22	36.5	93	26	0.113
		7.2 10	9421E07 10	22	36.5	93	26	0.114
		13	9421E07 13	22	36.5	97	30	0.119
C 9000 Series: single shut-off = 2000 NI/min								

9416E Coupler, Bulkhead Mountable, Female BSPP Thread

	Technical polymer, nickel-plated brass, NBR 	 C 	E	F	G	K_{max}	L1	L2	ØT_{min}	kg	
		7.2 G3/8	9416E07 17	12	24	36.5	7	14.5	74	22.5	0.153
		C 9000 Series: single shut-off = 2000 NI/min									

European Profile



9440E Y Coupler, Female BSPP Thread

	Technical polymer, nickel-plated brass, NBR 		C		E	F	F1	G	H	H1	kg
C 9000 Series: single shut-off = 2000 NI/min											

9087E Probe, Straight-Through, Male BSPP Thread

	Nickel-plated steel, technical polymer 		C		E	F	L	L1	kg		
										7.2 G1/4 9087E07 13	9 14 34 20 0.018
										7.2 G3/8 9087E07 17	9 17 34 20 0.025
										7.2 G1/2 9087E07 21	12 22 38 20 0.048
Probe without shut-off											

9086E Probe, Straight-Through, Female BSPP Thread

	Nickel-plated steel 		C		E	F	L	L1	kg		
										7.4 G1/8 9086 25 10	7 14 32 20 0.015
										7.4 G1/4 9086 25 13	9 17 38.5 20 0.027
										7.4 G3/8 9086 25 17	9 19 33 20 0.027
										7.4 G1/2 9086 25 21	12 24 36 20 0.050
Probe without shut-off											

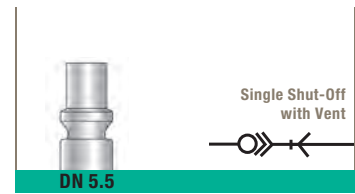
9080E Probe, Straight-Through, LF 3000® Push-In Connection, with Spiral Protection Spring

	Nickel-plated steel, NBR 		ØD		G	L	L1	kg		
									7.2 10 9080E07 10	24 114 20 0.102
									7.2 12 9080E07 12	29.5 125 20 0.088
Probe without shut-off										


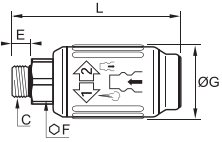


9094E Probe, Straight-Through, with Hosetail

	Nickel-plated steel 		ØD		F	L	L1	L2	kg		
										7.2 8 9094E07 08	17 48 20 25 0.014
										7.2 10 9094E07 10	17 48 20 25 0.016
										7.2 13 9094E07 13	17 48 20 25 0.019
Probe without shut-off											


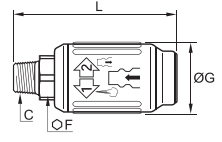


ARO Profile




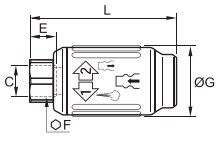


9401A Coupler, Male BSPP Thread

	Technical polymer, nickel-plated brass, NBR 	 C 	E	F	G	L	kg
		G1/4 9401A06 13	6.5	17	31.5	70.5	0.105
		5.5 G3/8 9401A06 17	9	21	31.5	73.5	0.123
		G1/2 9401A06 21	9	25	31.5	70.5	0.150
C 9000 series: single shut-off = 1250 NI/min							


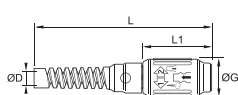


9405A Coupler, Male BSPT Thread

	Technical polymer, nickel-plated brass, NBR 	 C 	F	G	L	kg
		R1/4 9405A06 13	17	31.5	73	0.105
		5.5 R3/8 9405A06 17	19	31.5	74.5	0.110
		R1/2 9405A06 21	22	31.5	79.5	0.140
C 9000 series: single shut-off = 1250 NI/min						


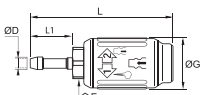


9414A Coupler, Female BSPP Thread

	Technical polymer, nickel-plated brass, NBR 	 C 	E	F	G	L	kg
		G1/4 9414A06 13	12	17	31.5	64.5	0.095
		5.5 G3/8 9414A06 17	12	22	31.5	70	0.115
		G1/2 9414A06 21	15	27	31.5	76	0.145
C 9000 series: single shut-off = 1250 NI/min							

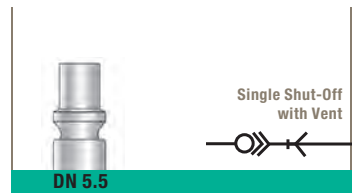
9410A Coupler, LF 3000® Push-In Connection, with Spiral Protection Spring

	Technical polymer, nickel-plated brass, NBR 	 ØD 	G	L	L1	kg
		8 9410A06 08	31.5	143	54	0.140
		5.5 10 9410A06 10	31.5	143	54	0.175
C 9000 series: single shut-off = 1250 NI/min						


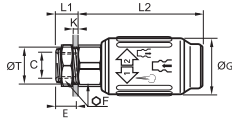


9421A Coupler with Hosetail

	Technical polymer, nickel-plated brass, NBR 	 ØD 	F	G	L	L1	kg
		6 9421A06 06	17	31.5	86.5	26	0.110
		5.5 8 9421A06 08	17	31.5	86.5	26	0.100
		10 9421A06 10	17	31.5	86.5	26	0.100
C 9000 series: single shut-off = 1250 NI/min							

ARO Profile


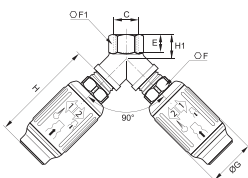




9416A Coupler, Bulkhead Mountable, Female BSPP Thread

	Technical polymer, nickel-plated brass, NBR 		C		E	F	G	K	L1	L2	ØT	kg


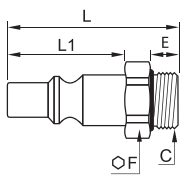


C 9000 series: single shut-off = 1250 NI/min

9440A Y Coupler, Female BSPP Thread

	Technical polymer, nickel-plated brass, NBR 		C		E	F	F1	G	H	H1	kg


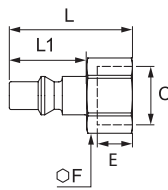


C 9000 series: single shut-off = 1250 NI/min

9087A Probe, Straight-Through, Male BSPP Thread

	Nickel-plated steel, technical polymer 		C		E	F	L	L1	kg								
										G1/4	9087A06 13	9	17	36	22	0.020	
										5.5	G3/8	9087A06 17	9	19	36	22	0.024
										G1/2	9087A06 21	12	24	40	22	0.039	


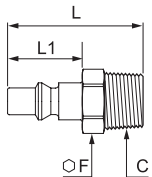


Probe without shut-off

9086A Probe, Straight-Through, Female BSPP Thread

	Nickel-plated steel 		C		E	F	L	L1	kg								
										G1/4	9086 22 13	9	17	35.5	22	0.024	
										5.5	G3/8	9086 22 17	10	19	35.5	22	0.023
										G1/2	9086 22 21	12	24	38	22	0.039	

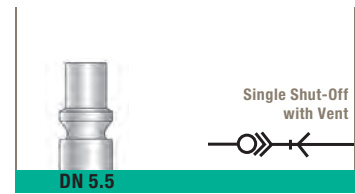
Probe without shut-off

9084A Probe, Straight-Through, Male BSPT Thread


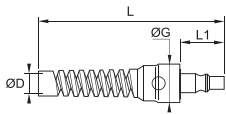


	Nickel-plated steel 		C		F	L	L1	kg							
									R1/4	9084 22 13	14	40.5	22	0.020	
									5.5	R3/8	9084 22 17	17	40.5	22	0.031
									R1/2	9084 22 21	22	46	22	0.048	

Probe without shut-off

ARO Profile


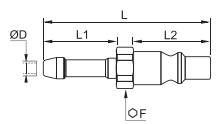




9080A Probe, Straight-Through, LF 3000® Push-In Connection, with Spiral Protection Spring

	Nickel-plated steel, NBR 	 ØD 	G	L	L1	kg		
		5.5	8	9080A06 08	24	118	22	0.028
			10	9080A06 10	24	118	22	0.027

Probe without shut-off

9094A Probe, Straight-Through, with Hosetail

	Nickel-plated steel 	 ØD 	F	L	L1	L2	kg		
		5.5	6	9094A06 06	14	48.5	22	25	0.012
			8	9094A06 08	14	48.5	22	25	0.014
	10	9094A06 10	14	48.5	22	25	0.016		

Probe without shut-off

Metal Quick-Acting Coupler Range

Nickel-Plated Brass Quick-Acting Couplers

ISO B Profile, 23, 24 and 30 Series



European Profile, 25, 26 and 27 Series



ARO Profile, 14 and 22 Series



ISO C Profile, 18 Series



Asian Profile, 13 Series



UK Profile, 17 and 19 Series



Metal Quick-Acting Coupler Range

Nickel-Plated Brass Quick-Acting Couplers

German Profile, 20 and 21 Series



Mini Series



Standard Series



Midi Series



Maxi Series



Metal Quick-Acting Coupler Range

Stainless Steel Quick-Acting Couplers

European Profile, X25 and X27 Series

9201 Page 8-47 **9214** Page 8-47 **9287** Page 8-47 **9087** Page 8-47 **9286** Page 8-47 **9086** Page 8-47



German Profile, X20 Series

9201 Page 8-48 **9214** Page 8-48 **9287** Page 8-48 **9087** Page 8-48 **9286** Page 8-48 **9086** Page 8-48



German Profile, X21 Series

9201 Page 8-49 **9214** Page 8-49 **9287** Page 8-49 **9087** Page 8-49 **9286** Page 8-49 **9086** Page 8-49



Quick-Acting Mould Couplers

9020 Page 8-51 **9040** Page 8-51 **9075** Page 8-51



Metal Quick-Acting Coupler Accessories

9071 Page 8-53 **0691** Page 8-53 **0681** Page 8-53 **0164** Page 8-53 **0167** Page 8-53



Metal Quick-Acting Couplers

In order to fulfill the requirements of the **widest range of industrial applications**, Parker Legris offers a range of metal couplers compatible with a large selection of fluids.

Simple to install, with or without shut-off valves, these couplers offer a **high flow rate capability**.

Product Advantages

Easy-to-Use | Coupler with sliding sleeve: automatic connection and disconnection
 Wide variety of male probes
 Extremely compact
 Single or double shut-off models for greater safety
 Special range designed for pneumatic applications: 13 Series to 27
 Special range designed for the transmission of water and fluids: Midi and Maxi series

Robust & Reliable | 100% leak-tested in production
 Excellent shock and impact resistance
 Nickel-plated brass for corrosion resistance
 Stainless steel version for restrictive environments

Optimum Performance | Very wide range of flow rates
 "UltraFlo" technology: 18, 22, 23, 25 and 27 series
 Low pressure drop
 Long service life
 Maximum energy efficiency



Applications

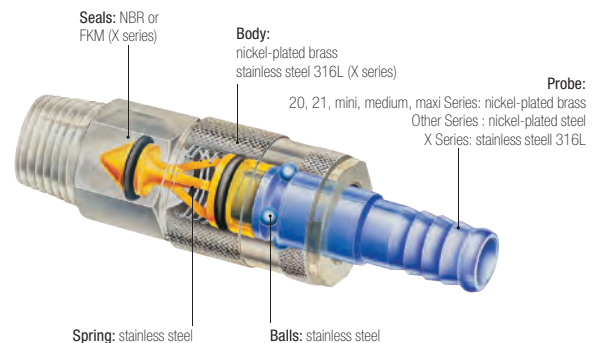
- Workshops
- Flushing
- Spraying
- Packaging
- Factory Automation
- Filling Systems
- Cleaning

Technical Characteristics

Compatible Fluids	Compressed air, water (see compatibility chart below)
Working Pressure	0 to 20 bar 0 to 35 bar (stainless steel series)
Working Temperature	-20°C to +100°C -15°C to +200°C (stainless steel series)

Guaranteed for use with a vacuum of 655 mm Hg (86% vacuum).

Component Materials

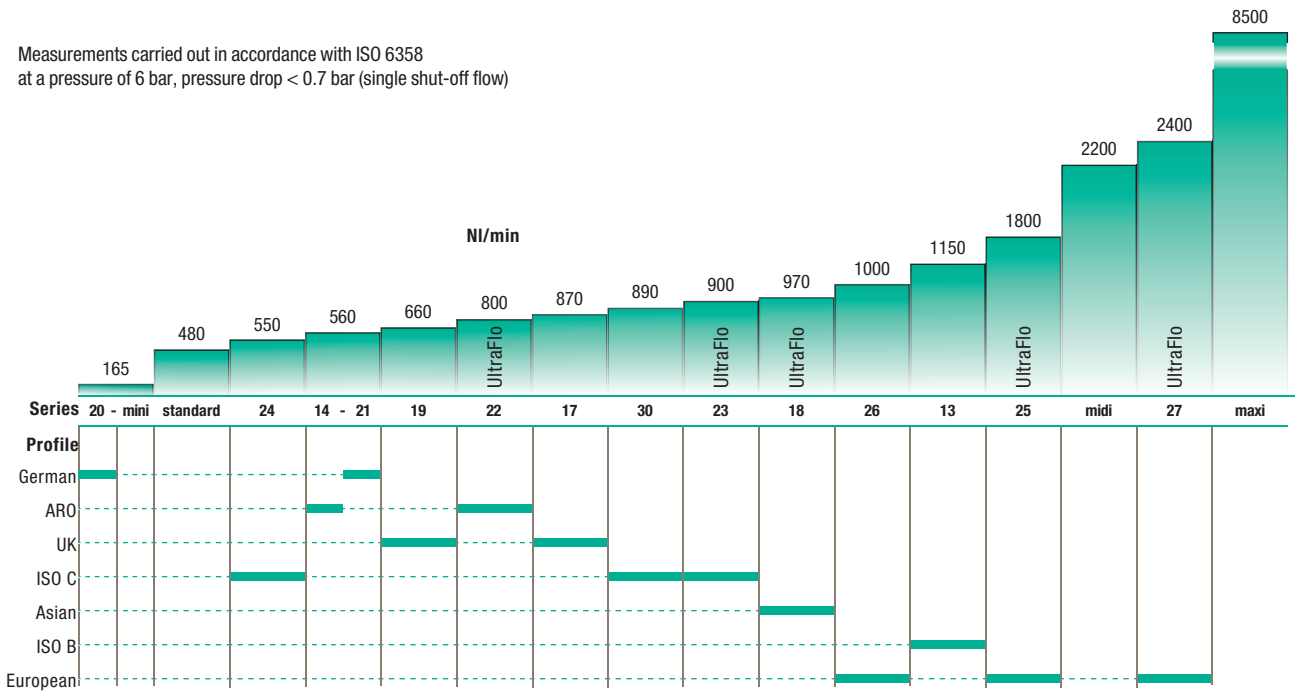


Silicone-free

Metal Quick-Acting Couplers

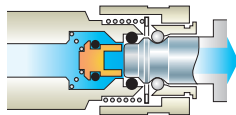
Metal Quick-Acting Coupler Technology and Flow Rates

Measurements carried out in accordance with ISO 6358
at a pressure of 6 bar, pressure drop < 0.7 bar (single shut-off flow)



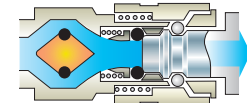
"Typical" quick-acting coupler

Standard "poppet" technology
Flow: 1000 NI/min



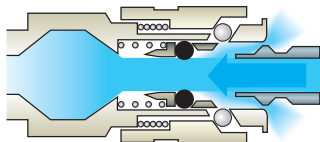
UltraFlo quick-acting coupler

"Optimal flow" technology
Flow: 1700 NI/min

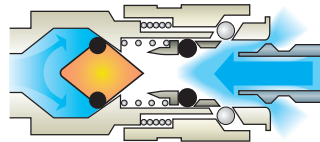
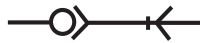


3 Shut-Off Functions

Straight-Through

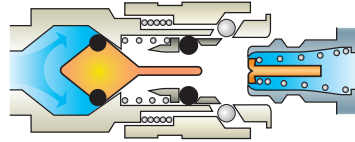


Single Shut-Off



Single shut-off coupler
+ probe without shut-off
When disconnected, the fluid path is closed
upstream (body side).

Double Shut-Off

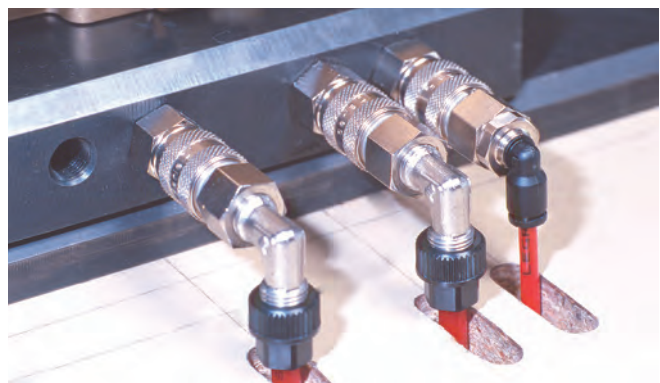


Double shut-off coupler
+ probe with shut-off
When disconnected, the fluid path is closed
upstream (body side) and downstream (probe side).

Operation



Installation Options



Chemical Compatibility Chart for Metal Couplers

Below are the fluids compatible with Parker Legris metal quick-acting couplers.
This list is not exhaustive: if your fluid is not shown here, please contact us.

Acetamide

Ammonium chloride
Ammonium in solution
Argon
ASTM no. 1 oil
ASTM no. 2 oil
ASTM no. 3 oil

Butyl alcohol

Calcium carbonate

Castor oil
Coconut oil
Cod liver oil
Cold ammonium
Corn oil
Cotton seed oil
Cyclohexane

Detergents

Diesel oil
Diethylene glycol

Engine oil

Ethane
Ethanol
Ethyl alcohol
Ethyl silicate
Ethylene glycol

Fuel oil

Gear oil

Glycerin
Glycerol triacetate
Glycol
Groundnut oil

Heating oil (petroleum-based)

Helium

Heptane N

Hexane N

Hexyl alcohol

Hydraulic liquids:

H group
H-L group
H-LP group
HSA group
HSB group
HSD c (T) group in accordance with
DIN 51524 and 51525

Isododecane

Isooctane

Lard

Linseed oil
Methanol
Mineral oil
Neatsfoot oil

N-Heptane

N-Hexane
Nitrogen
N-Pentane

Octadecane

Olive oil

Pentane N

Petroleum
Propyl alcohol
Propylene glycol

Seawater

Silicone grease
Soap solution
Sodium hydroxide
Sodium sulphate

Soya bean oil

Stearyl alcohol

Terebenthine

Trisodium phosphate

Vaseline

Vaseline oil
Vegetable oil

Water

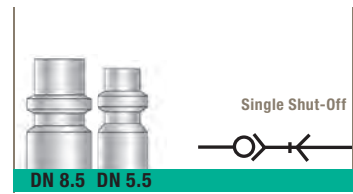
Wood oil

Zinc chloride

The above recommendations are given in good faith. However, since each application is different, it is advisable to undertake tests in actual working conditions.

ISO B Profile

23, 24 and 30 Series



9101 Coupler, Male BSPP Thread

	Nickel-plated brass, NBR 	DN C		E F G L kg							
					G1/4	9101 23 13	9	19	23	57	0.091
					5.5 G3/8	9101 23 17	9	19	23	57	0.093
					G1/2	9101 23 21	12	22	23	60	0.132
23 Series (DN 5.5): single shut-off = 900 NI/min											

9101 Coupler, Male BSPP Thread

	Nickel-plated brass, NBR 	DN C		E F G L kg							
					G1/4	9101 24 13	9	22	27	43	0.079
					5.5 G3/8	9101 24 17	9	22	27	43	0.082
					G1/2	9101 24 21	12	24	27	46	0.093
					G1/4	9101 30 13	9	22	29	49	0.097
					8.5 G3/8	9101 30 17	9	22	29	49	0.099
G1/2	9101 30 21	12	22	29	52	0.110					
24 Series (DN 5.5): single shut-off = 550 NI/min 30 Series (DN 8.5): single shut-off = 890 NI/min											

9114 Coupler, Female BSPP Thread

	Nickel-plated brass, NBR 	DN C		E F G L kg							
					G1/4	9114 23 13	9	19	23	55	0.095
					5.5 G3/8	9114 23 17	9	19	23	55	0.087
					G1/2	9114 23 21	12	24	23	57	0.120
23 Series (DN 5.5): single shut-off = 900 NI/min											

9114 Coupler, Female BSPP Thread

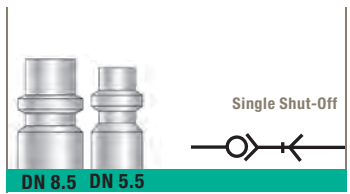
	Nickel-plated brass, NBR 	DN C		E F G L kg							
					G1/4	9114 24 13	9	22	27	43	0.096
					5.5 G3/8	9114 24 17	9	22	27	43	0.091
					G1/2	9114 24 21	12	24	27	46	0.098
					G1/4	9114 30 13	9	22	29	49	0.113
					8.5 G3/8	9114 30 17	9	22	29	49	0.107
G1/2	9114 30 21	12	24	29	52	0.115					
24 Series (DN 5.5): single shut-off = 550 NI/min 30 Series (DN 8.5): single shut-off = 890 NI/min											

9123 Coupler with Barb Connection


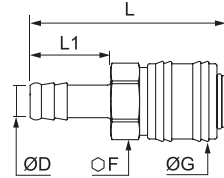

	Nickel-plated brass, NBR 	DN ØD		F G L L1 kg							
					6	9123 23 06	19	23	73	25	0.091
					5.5 8	9123 23 08	19	23	73	25	0.092
					10	9123 23 10	19	23	73	25	0.094
23 Series (DN 5.5): single shut-off = 900 NI/min											

ISO B Profile


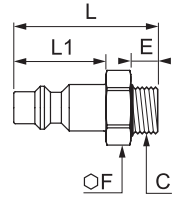

23, 24 and 30 Series




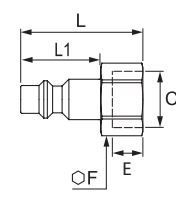

9123 Coupler with Barb Connection

	Nickel-plated brass, NBR 		DN	ØD	F	G	L	L1	kg	
			6	9123 24 06	21	27	60	25	0.081	
			5.5	8	9123 24 08	21	27	60	25	0.082
				10	9123 24 10	21	27	60	25	0.082
				8	9123 30 08	22	30	66	25	0.098
				10	9123 30 10	22	30	66	25	0.098
				13	9123 30 13	22	30	66	25	0.103
				24 Series (DN 5.5): single shut-off = 550 NI/min 30 Series (DN 8.5): single shut-off = 890 NI/min						


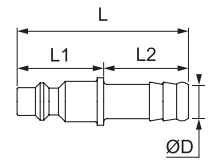

9087 Probe, Straight-Through, Male BSPP Thread

	Nickel-plated steel, technical polymer 		DN	C	E	F	L	L1	kg		
			5.5	G1/8	9087 23 10	9	13	39	24	0.017	
			5.5	G1/4	9087 23 13	9	17	38	24	0.025	
				G3/8	9087 23 17	9	19	38	24	0.032	
				G1/2	9087 23 21	12	22	42	24	0.048	
				8.5	G1/4	9087 30 13	9	17	42	28	0.030
				G3/8	9087 30 17	9	19	42	28	0.036	
				G1/2	9087 30 21	12	24	46	28	0.058	
Probe without shut-off 23 Series probe (DN 5.5) compatible with 24 Series coupler (DN 5.5)											


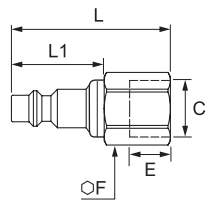

9086 Probe, Straight-Through, Female BSPP Thread

	Nickel-plated steel 		DN	C	E	F	L	L1	kg		
			5.5	G1/8	9086 23 10	9	17	36	24	0.021	
			5.5	G1/4	9086 23 13	9	17	36	24	0.025	
				G3/8	9086 23 17	9	19	36	24	0.025	
				G1/2	9086 23 21	12	24	39	24	0.039	
				8.5	G1/4	9086 30 13	10	17	40	28	0.032
				G3/8	9086 30 17	10	19	42	28	0.035	
				G1/2	9086 30 21	12	24	43	28	0.046	
Probe without shut-off 23 Series probe (DN 5.5) compatible with 24 Series coupler (DN 5.5)											

9085 Probe, Straight-Through, with Barb Connection

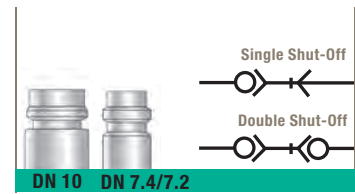
	Nickel-plated steel 		DN	ØD	L	L1	L2	kg	
			5.5	6	9085 23 06	51	24	25	0.016
			5.5	8	9085 23 08	51	27	25	0.017
				10	9085 23 10	51	24	25	0.018
				8	9085 30 08	55	28	25	0.027
				10	9085 30 10	55	28	25	0.028
				13	9085 30 13	55	28	25	0.031
				Probe without shut-off 23 Series probe (DN 5.5) compatible with 24 Series coupler (DN 5.5)					

9293 Probe, Valved, Anti-Whiplash, Female BSPP Thread


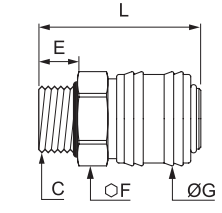


	Nickel-plated steel, NBR 		DN	C	E	F	L	L1	kg
			5.5	G1/4	9293 23 13	10	22	47	24
Probe with shut-off									

European Profile


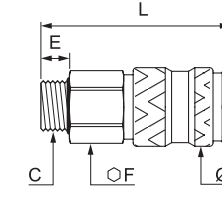


25, 26 and 27 Series




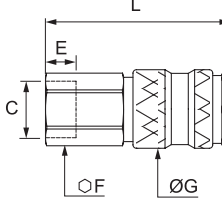


9101 Coupler, Male BSPP Thread

	Nickel-plated brass, NBR 	 C 	E	F	G	L	kg		
		7.2	G1/8	9101 26 10	9	22	27	43	0.073
			G1/4	9101 26 13	9	22	27	43	0.073
			G3/8	9101 26 17	9	22	27	13	0.075
			G1/2	9101 26 21	12	22	27	46	0.087
26 Series (DN 7.2): single shut-off = 1000 NL/min									


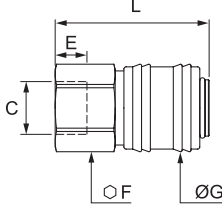


9201 Coupler, Male BSPP Thread

	Nickel-plated brass, NBR 	 C 	E	F	G	L	kg		
		7.4	G1/4	9201 25 13	9	19	23	57	0.095
			G3/8	9201 25 17	9	19	23	57	0.097
			G1/2	9201 25 21	12	22	23	60	0.135
		10	G3/8	9201 27 17	9	24	27	65	0.160
			G1/2	9201 27 21	12	24	27	70	0.166
			G3/4	9201 27 27	16	27	27	74	0.239
25 Series (DN 7.4): single shut-off = 1800 NL/min / 25 Series (DN 7.4): double shut-off = 710 NL/min 27 Series (DN 10): single shut-off = 2400 NL/min / 27 Series (DN 7.4): double shut-off = 900 NL/min									


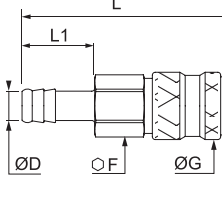


9214 Coupler, Female BSPP Thread

	Nickel-plated brass, NBR 	 C 	E	F	G	L	kg		
		7.4	G1/4	9214 25 13	9	19	23	55	0.098
			G3/8	9214 25 17	9	19	23	55	0.092
			G1/2	9214 25 21	12	24	23	57	0.124
		10	G3/8	9214 27 17	12	24	27	68	0.177
			G1/2	9214 27 21	12	24	27	68	0.166
			G3/4	9214 27 27	16	32	27	74	0.255
25 Series (DN 7.4): single shut-off = 1800 NL/min / 25 Series (DN 7.4): double shut-off = 710 NL/min 27 Series (DN 10): single shut-off = 2400 NL/min / 27 Series (DN 7.4): double shut-off = 900 NL/min									

9114 Coupler, Female BSPP Thread

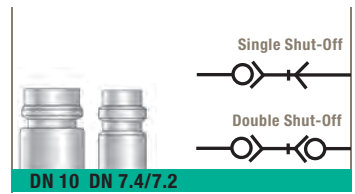
	Nickel-plated brass, NBR 	 C 	E	F	G	L	kg		
		7.2	G1/4	9114 26 13	9	22	27	43	0.089
			G3/8	9114 26 17	9	22	27	43	0.084
			G1/2	9114 26 21	12	24	27	46	0.090
26 Series (DN 7.2): single shut-off = 1000 NL/min									

9223 Coupler with Barb Connection

	Nickel-plated brass, NBR 	 ØD 	F	G	L	L1	kg		
		7.4	6	9223 25 06	19	23	73	25	0.095
			8	9223 25 08	19	23	73	25	0.097
			10	9223 25 10	19	23	73	25	0.097
			13	9223 25 13	19	23	73	25	0.099
		10	8	9223 27 08	24	27	80	21	0.146
			10	9223 27 10	24	27	80	21	0.162
			13	9223 27 13	24	27	80	21	0.164
			19	9223 27 19	24	27	80	21	0.168
		25 Series (DN 7.4): single shut-off = 1800 NL/min / 25 Series (DN 7.4): double shut-off = 710 NL/min 27 Series (DN 10): single shut-off = 2400 NL/min / 27 Series (DN 7.4): double shut-off = 900 NL/min							

European Profile

25, 26 and 27 Series



9087 Probe, Straight-Through, Male BSPP Thread

	Nickel-plated steel, technical polymer		DN	C		E	F	L	L1	kg
			7.4	G1/8	9087 25 10	7	13	31	20	0.018
				G1/4	9087 25 13	9	14	34	20	0.018
				G3/8	9087 25 17	9	17	34	20	0.025
				G1/2	9087 25 21	12	22	38	20	0.047
			10	G3/8	9087 27 17	9	19	37	22	0.031
				G1/2	9087 27 21	12	22	40	22	0.046
				G3/4	9087 27 27	16	32	45	22	0.085

Probe without shut-off
25 Series probe (DN 7.4) compatible with 26 Series coupler (DN 7.2)

9086 Probe, Straight-Through, Female BSPP Thread

	Nickel-plated steel		DN	C		E	F	L	L1	kg
			7.4	G1/8	9086 25 10	7	14	32	20	0.015
				G1/4	9086 25 13	9	17	38.5	20	0.027
				G3/8	9086 25 17	9	19	33	20	0.027
				G1/2	9086 25 21	12	24	36	20	0.050
			10	G3/8	9086 27 17	9	19	34	22	0.026
				G1/2	9086 27 21	12	24	38	22	0.041
				G3/4	9086 27 27	16	32	42	22	0.090

Probe without shut-off
25 Series probe (DN 7.4) compatible with 26 Series coupler (DN 7.2)

9085 Probe, Straight-Through, with Barb Connection

	Nickel-plated steel		DN	ØD		L	L1	L2	kg
			7.4	6	9085 25 06	48	20	25	0.013
				8	9085 25 08	48	20	25	0.015
				9	9085 25 09	48	20	25	0.015
				10	9085 25 10	48	20	25	0.016
				13	9085 25 13	48	20	25	0.020
			10	8	9085 27 08	48	22	25	0.021
				10	9085 27 10	48	22	25	0.023
				13	9085 27 13	48	22	25	0.026
				19	9085 27 19	48	22	25	0.038

Probe without shut-off
25 Series probe (DN 7.4) compatible with 26 Series coupler (DN 7.2)

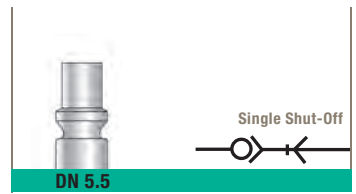
9287 Probe, Valved, Male BSPP Thread

	Nickel-plated brass, NBR		DN	C		E	F	L	L1	kg
			7.4	G1/8	9287 25 10	7	22	41	20	0.046
				G1/4	9287 25 13	9	22	43	20	0.046
				G3/8	9287 25 17	9	22	43	20	0.049
				G1/2	9287 25 21	12	22	46	20	0.060
			10	G3/8	9287 27 17	9	24	58	22	0.086
				G1/2	9287 27 21	12	24	58	22	0.090
				G3/4	9287 27 27	16	27	62	22	0.132

Probe with shut-off
25 Series probe (DN 7.4) not compatible with 26 Series coupler (DN 7.2)

ARO Profile

14 and 22 Series



9101 Coupler, Male BSPP Thread

	Nickel-plated brass, NBR			E F G L kg		
		(DN) C			G1/4 9101 14 13	9 22 27 43 0.080
		5.5 G3/8 9101 14 17			9 22 27 43 0.081	
		G1/2 9101 14 21			12 24 27 46 0.093	
14 Series (DN 5.5): single shut-off = 560 NI/min						

9105 Coupler, Male BSPT Thread

	Nickel-plated brass, NBR			F G L kg		
		(DN) C			R1/4 9105 22 13	19 23 61 0.098
		5.5 R3/8 9105 22 17			12 19 60 0.096	
		R1/2 9105 22 21			22 23 61 0.114	
22 Series (DN 5.5): single shut-off = 800 NI/min						

9114 Coupler, Female BSPP Thread

	Nickel-plated brass, NBR			E F G L kg		
		(DN) C			G1/4 9114 14 13	9 22 27 43 0.095
		5.5 G3/8 9114 14 17			9 22 27 43 0.091	
		G1/2 9114 14 21			12 24 27 46 0.098	
14 Series (DN 5.5): single shut-off = 560 NI/min						

9114 Coupler, Female BSPP Thread

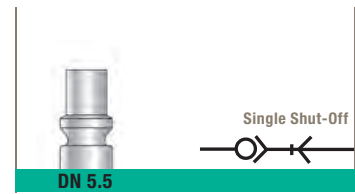
	Nickel-plated brass, NBR			E F G L kg		
		(DN) C			G1/4 9114 22 13	9 19 23 56 0.098
		5.5 G3/8 9114 22 17			9 19 23 55 0.091	
		G1/2 9114 22 21			12 24 23 58 0.123	
22 Series (DN 5.5): single shut-off = 800 NI/min						

9123 Coupler with Barb Connection


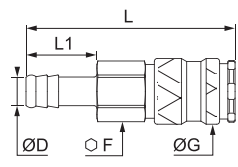


	Nickel-plated brass, NBR			F G L L1 kg		
		(DN) ØD			6 9123 14 06	21 27 60 25 0.080
		8 9123 14 08			21 27 60 25 0.081	
		5.5 9 9123 14 09			21 27 60 25 0.082	
		10 9123 14 10			21 27 60 25 0.082	
		13 9123 14 13			21 27 60 25 0.094	
14 Series (DN 5.5): single shut-off = 560 NI/min						

ARO Profile


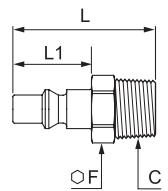


14 and 22 Series




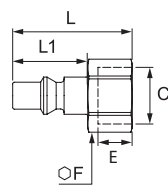


9123 Coupler with Barb Connection

	Nickel-plated brass, NBR 	 ØD 	F	G	L	L1	kg
		6 9123 22 06	19	23	74	25	0.093
		5.5 8 9123 22 08	19	23	74	25	0.097
		10 9123 22 10	19	23	74	25	0.098
22 Series (DN 5.5): single shut-off = 800 Nl/min							


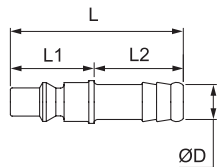


9084 Probe, Straight-Through, Male BSPT Thread

	Nickel-plated steel 	 C 	F	L	L1	kg
		R1/4 9084 22 13	14	40.5	22	0.020
		5.5 R3/8 9084 22 17	17	40.5	22	0.031
		R1/2 9084 22 21	22	46	22	0.048
Probe without shut-off 22 Series probe (DN 5.5) compatible with 14 Series coupler (DN 5.5)						

9086 Probe, Straight-Through, Female BSPP Thread

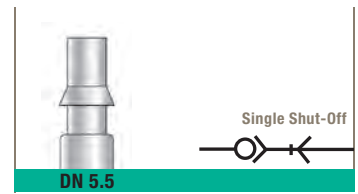
	Nickel-plated steel 	 C 	E	F	L	L1	kg
		G1/4 9086 22 13	9	17	35.5	22	0.024
		5.5 G3/8 9086 22 17	10	19	35.5	22	0.023
		G1/2 9086 22 21	12	24	38	22	0.039
Probe without shut-off 22 Series probe (DN 5.5) compatible with 14 Series coupler (DN 5.5)							

9085 Probe, Straight-Through, with Barb Connection


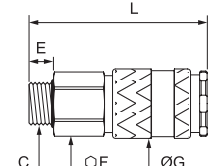


	Nickel-plated steel 	 ØD 	L	L1	L2	kg
		6 9085 22 06	48.5	22	25	0.012
		8 9085 22 08	48.5	22	25	0.014
		5.5 9 9085 22 09	48.5	22	25	0.014
		10 9085 22 10	48.5	22	25	0.016
		13 9085 22 13	48.5	22	25	0.022
Probe without shut-off 22 Series probe (DN 5.5) compatible with 14 Series coupler (DN 5.5)						

ISO C Profile

18 Series


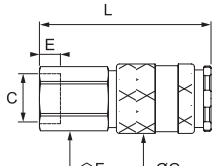




9101 Coupler, Male BSPP Thread

	Nickel-plated brass, NBR 		DN	C		E	F	G	L	kg								
											5.5	G1/4	9101 18 13	9	19	23	60	0.106
												G3/8	9101 18 17	9	19	23	60	0.108


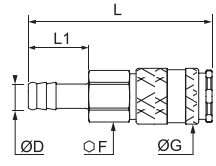


18 Series (DN 5.5) : single shut-off = 970 NI/min

9114 Coupler, Female BSPP Thread

	Nickel-plated brass, NBR 		DN	C		E	F	G	L	kg								
											5.5	G1/4	9114 18 13	9	19	23	58	0.109
												G3/8	9114 18 17	9	19	23	58	0.101


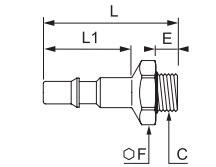


18 Series (DN 5.5) : single shut-off = 970 NI/min

9123 Coupler with Barb Connection

	Nickel-plated brass, NBR 		DN	ØD		F	G	L	L1	kg								
											5.5	6	9123 18 06	19	23	76	25	0.104
												8	9123 18 08	19	23	76	25	0.106
	10	9123 18 10	19	23	76	25	0.108											


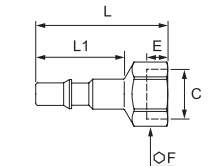


18 Series (DN 5.5) : single shut-off = 970 NI/min

9087 Probe, Straight-Through, Male BSPP Thread

	Nickel-plated steel 		DN	C		E	F	L	L1	kg								
											5.5	G1/4	9087 18 13	9	17	41	28	0.025
												G3/8	9087 18 17	9	19	41	28	0.028


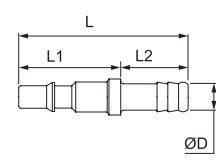


Probe without shut-off

9086 Probe, Straight-Through, Female BSPP Thread

	Nickel-plated steel 		DN	C		E	F	L	L1	kg								
											5.5	G1/4	9086 18 13	9	17	40	28	0.022
												G3/8	9086 18 17	9	19	41	28	0.024

Probe without shut-off

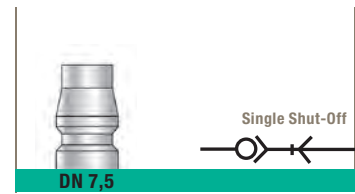
9085 Probe, Straight-Through, with Barb Connection

	Nickel-plated steel 		DN	ØD		L	L1	L2	kg							
										5.5	6	9085 18 06	56	28	25	0.016
											8	9085 18 08	56	28	25	0.016
	10	9085 18 10	56	28	25	0.018										

Probe without shut-off

Asian Profile

13 Series



9105 Coupler, Male BSPT Thread

	Nickel-plated brass, NBR 	C	F	G	L	kg		
		R1/4	9105 13 13	22	27	49	0.086	
		7.5	R3/8	9105 13 17	22	27	49	0.090
			R1/2	9105 13 21	22	27	53	0.110
13 Series (DN 7.5): single shut-off = 1150 NL/min								

9114 Coupler, Female BSPP Thread

	Nickel-plated brass, NBR 	C	E	F	G	L	kg		
		G1/4	9114 13 13	9	22	27	45	0.099	
		7.5	G3/8	9114 13 17	9	22	27	45	0.093
			G1/2	9114 13 21	12	24	27	48	0.102
13 Series (DN 7.5): single shut-off = 1150 NL/min									

9123 Coupler with Barb Connection

	Nickel-plated brass, NBR 	ØD	F	G	L	L1	kg		
		8	9123 13 08	21	27	62	25	0.084	
		7.5	10	9123 13 10	21	27	62	25	0.086
			13	9123 13 13	21	27	62	25	0.089
13 Series (DN 7.5): single shut-off = 1150 NL/min									

9084 Probe, Straight-Through, Male BSPT Thread

	Nickel-plated steel 	C	F	L	L1	kg		
		R1/4	9084 13 13	14	37	12	0.022	
		7.5	R3/8	9084 13 17	17	37	12	0.028
			R1/2	9084 13 21	22	44	17	0.050
Probe without shut-off								

9086 Probe, Straight-Through, Female BSPP Thread

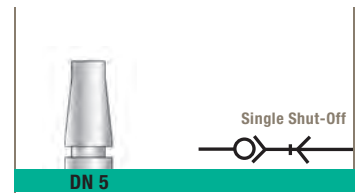
	Nickel-plated steel 	C	E	F	L	L1	kg		
		G1/4	9086 13 13	9	17	22	12	0.026	
		7.5	G3/8	9086 13 17	9	19	33	12	0.024
			G1/2	9086 13 21	12	24	36	17	0.036
Probe without shut-off									

9085 Probe, Straight-Through, with Barb Connection

	Nickel-plated steel 	ØD	L	L1	kg		
		8	9085 13 08	48	25	0.020	
		7.5	10	9085 13 10	48	25	0.021
			13	9085 13 13	48	25	0.026
Probe without shut-off							

UK Profile

17 Series



9105 Coupler, Male BSPT Thread

	Nickel-plated brass, NBR		$\overline{\text{DN}}$	C		F	G	L	kg
				R1/4	9105 17 13	19	23	63	0.109
			5	R3/8	9105 17 17	19	23	62	0.108
				R1/2	9105 17 21	22	23	63	0.124
17 Series (DN 5) : Single shut-off = 870 NI/min									

9114 Coupler, Female BSPP Thread

	Nickel-plated brass, NBR		$\overline{\text{DN}}$	C		E	F	G	L	kg
				G1/4	9114 17 13	9	19	23	58	0.110
			5	G3/8	9114 17 17	9	19	23	57	0.103
				G1/2	9114 17 21	12	24	23	60	0.135
17 Series (DN 5) : Single shut-off = 870 NI/min										

9123 Coupler with Barb Connection

	Nickel-plated brass, NBR		$\overline{\text{DN}}$	ØD		F	G	L	L1	kg
				6	9123 17 06	19	23	76	25	0.106
			5	8	9123 17 08	19	23	76	25	0.108
				10	9123 17 10	19	23	76	25	0.111
17 Series (DN 5): single shut-off = 870 NI/min										

9084 Probe, Straight-Through, Male BSPT Thread

	Nickel-plated steel		$\overline{\text{DN}}$	C		F	L	L1	kg
				R1/8	9084 17 10	11	37	9	0.016
			5	R1/4	9084 17 13	14	42	12	0.021
				R3/8	9084 17 17	17	42	12	0.014
				R1/2	9084 17 21	22	48	17	0.048
Probe without shut-off									

9086 Probe, Straight-Through, Female BSPP Thread

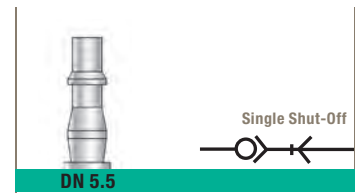
	Nickel-plated steel		$\overline{\text{DN}}$	C		E	F	L	kg
				G1/8	9086 17 10	7	14	33	0.016
			5	G1/4	9086 17 13	9	17	33	0.022
				G3/8	9086 17 17	9	19	33	0.023
				G1/2	9086 17 21	12	24	36	0.030
Probe without shut-off									

9085 Probe, Straight-Through, with Barb Connection

	Nickel-plated steel		$\overline{\text{DN}}$	ØD		L	L1	L2	kg
				6	9085 17 06	58	25	33	0.015
			5	8	9085 17 08	52	25	27	0.016
				10	9085 17 10	52	25	27	0.018
Probe without shut-off									

UK Profile

19 Series



9105 Coupler, Male BSPT Thread

	Nickel-plated brass, NBR		DN	C		F	G	L	kg
			R1/4	9105 19 13	19	23	63	0.100	
			5.5	R3/8	9105 19 17	19	23	62	0.099
			R1/2	9105 19 21	22	23	68	0.117	
19 Series (DN 5.5): single shut-off = 660 NI/min									

9114 Coupler, Female BSPP Thread

	Nickel-plated brass, NBR		DN	C		E	F	G	L	kg
			G1/4	9114 19 13	9	19	23	58	0.102	
			5.5	G3/8	9114 19 17	9	19	23	58	0.095
			G1/2	9114 19 21	12	24	23	60	0.127	
19 Series (DN 5.5): single shut-off = 660 NI/min										

9123 Coupler with Barb Connection

	Nickel-plated brass, NBR		DN	OD		F	G	L	L1	kg
			6	9123 19 06	19	23	76	25	0.097	
			5.5	8	9123 19 08	19	23	76	25	0.099
			10	9123 19 10	24	23	76	25	0.100	
19 Series (DN 5.5): single shut-off = 660 NI/min										

9084 Probe, Straight-Through, Male BSPT Thread

	Nickel-plated steel		DN	C		F	L	L1	kg
			R1/4	9084 19 13	14	50	12	0.022	
			5.5	R3/8	9084 19 17	17	50	12	0.026
			R1/2	9084 19 21	22	56	17	0.051	
Probe without shut-off									

9086 Probe, Straight-Through, Female BSPP Thread

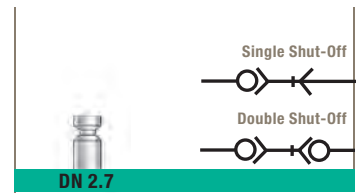
	Nickel-plated steel		DN	C		E	F	L	kg
			G1/4	9086 19 13	9	17	46	0.025	
			5.5	G3/8	9086 19 17	9	19	47	0.026
			G1/2	9086 19 21	12	24	50	0.039	
Probe without shut-off									

9085 Probe, Straight-Through, with Barb Connection

	Nickel-plated steel		DN	OD		L	L1	L2	kg
			6	9085 19 06	60	25	35	0.016	
			5.5	8	9085 19 08	60	25	35	0.017
			10	9085 19 10	60	25	35	0.019	
Probe without shut-off									

German Profile

20 Series



9201 Coupler, Male BSPP and Metric Thread

	Nickel-plated brass, NBR		DN	C		E	F	G	L	kg
			2.7	M5x0.8	9201 20 19	5	9	10	26	0.009
				G1/8	9201 20 10	7	11	10	28	0.012

20 Series (DN 2.7): single shut-off = 165 Nl/min
20 Series (DN 2.7): double shut-off = 130 Nl/min

9214 Coupler, Female BSPP and Metric Thread

	Nickel-plated brass, NBR		DN	C		E	F	G	L	kg
			2.7	M5x0.8	9214 20 19	5	9	10	25	0.010
				G1/8	9214 20 10	7	12	10	28	0.013

20 Series (DN 2.7): single shut-off = 165 Nl/min
20 Series (DN 2.7): double shut-off = 130 Nl/min

9226 Coupler, Bulkhead Mountable, with Barb Connection

	Nickel-plated brass, NBR		DN	ØD		F1	F2	G	L	L1	L2	kg
			2.7	3	9226 20 03	12	11	10	51	17	13	0.015
				4	9226 20 04	12	11	10	51	17	13	0.016

20 Series (DN 2.7): single shut-off = 165 Nl/min
20 Series (DN 2.7): double shut-off = 130 Nl/min

9087 Probe, Straight-Through, Male BSPP and Metric Thread

	Nickel-plated brass		DN	C		E	F	L	L1	kg
			2.7	M5x0.8	9087 20 19	5	7	18	10	0.002
				G1/8	9087 20 10	7	11	18	10	0.005

Probe without shut-off

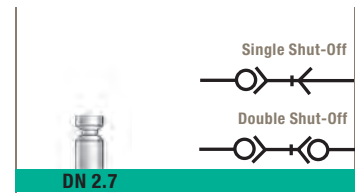
9287 Probe, Valved, Male BSPP and Metric Thread

	Nickel-plated brass, NBR		DN	C		E	F	L	L1	kg
			2.7	M5x0.8	9287 20 19	5	7	28	10	0.006
				G1/8	9287 20 10	7	11	30	10	0.009

Probe with shut-off

German Profile

20 Series



9086 Probe, Straight-Through, Female BSPP and Metric Thread

	Nickel-plated brass		DN	C		E	F	L	L1	kg
			2.7	M5x0.8	9086 20 19	5	7	17	10	0.003
				G1/8	9086 20 10	7	12	19	10	0.006
Probe without shut-off										

9286 Probe, Valved, Female BSPP and Metric Thread

	Nickel-plated brass, NBR		DN	C		E	F	L	L1	kg
			2.7	M5x0.8	9286 20 19	5	7	27	10	0.007
				G1/8	9286 20 10	7	12	30	10	0.010
Probe with shut-off										

9085 Probe, Straight-Through, with Barb Connection

	Nickel-plated brass		DN	ØD		L	L1	L2	kg
			2.7	3	9085 20 03	24	10	13	0.002
				4	9085 20 04	24	10	13	0.002
				5	9085 20 05	24	9	13	0.003
Probe without shut-off									

9285 Probe, Valved, with Barb Connection

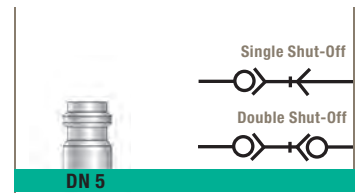
	Nickel-plated brass, NBR		DN	ØD		L	L1	L2	kg
			2.7	3	9285 20 03	37	10	13	0.007
				4	9285 20 04	37	10	13	0.007
				5	9285 20 05	37	10	13	0.007
Probe with shut-off									

9095 Probe, Straight-Through, Bulkhead Mountable, with Barb Connection

	Nickel-plated brass		DN	ØD		F	L	L1	L2	L3	kg
			2.7	3	9095 20 03	11	44	10	17	13	0.012
				4	9095 20 04	11	44	10	17	13	0.012
			Probe without shut-off								

German Profile

21 Series



9201 Coupler, Male BSPP Thread

	Nickel-plated brass, NBR			C		E	F	G	L	kg
			5	G1/8	9201 21 10	7	14	16	36	0.027
						9	17	16	38	0.036
			21 Series (DN 5): single shut-off = 560 NI/min 21 Series (DN 5): double shut-off = 310 NI/min							

9214 Coupler, Female BSPP Thread

	Nickel-plated brass, NBR			C		E	F	G	L	kg
			5	G1/8	9214 21 10	9	14	16	36	0.030
						7	17	16	38	0.040
			21 Series (DN 5): single shut-off = 560 NI/min 21 Series (DN 5): double shut-off = 310 NI/min							

9223 Coupler with Barb Connection

	Nickel-plated brass, NBR			ØD		F	G	L	L1	kg
			5	4	9223 21 04	14	16	46	17	0.027
						14	16	46	17	0.027
						14	16	46	17	0.028
			21 Series (DN 5): single shut-off = 560 NI/min 21 Series (DN 5): double shut-off = 310 NI/min							

9226 Coupler, Bulkhead Mountable, with Barb Connection

	Nickel-plated brass, NBR			ØD		F1	F2	G	L	L1	L2	kg
			5	4	9226 21 04	14	14	16	60	14	17	0.034
						17	17	16	60	14	17	0.048
						17	17	16	60	14	17	0.047
			21 Series (DN 5): single shut-off = 560 NI/min 21 Series (DN 5): double shut-off = 310 NI/min									

9087 Probe, Straight-Through, Male BSPP Thread

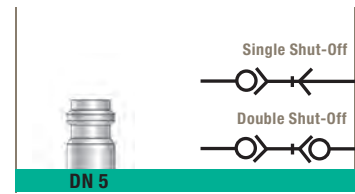
	Nickel-plated brass			C		E	F	L	L1	kg
			5	G1/8	9087 21 10	7	14	25	14	0.012
						9	17	28	14	0.019
			Probe without shut-off							

9287 Probe, Valved, Male BSPP Thread

	Nickel-plated brass, NBR			C		E	F	L	L1	kg
			5	G1/8	9287 21 10	7	14	40	14	0.023
						9	17	42	14	0.031
			Probe with shut-off							

German Profile

21 Series



9086 Probe, Straight-Through, Female BSPP Thread

	Nickel-plated brass		C	E	F	L	L1	kg		
			5	G1/8	9086 21 10	8	14	25	14	0.014
				G1/4	9086 21 13	9	17	26	14	0.018
Probe without shut-off										

9286 Probe, Valved, Female BSPP Thread

	Nickel-plated brass, NBR		C	E	F	L	L1	kg		
			5	G1/8	9286 21 10	8	14	40	14	0.025
				G1/4	9286 21 13	9	17	42	14	0.035
Probe with shut-off										

9085 Probe, Straight-Through, with Barb Connection

	Nickel-plated brass		ØD	L	L1	L2	kg						
			5	4	9085 21 04	32	14	17	0.006				
				6	9085 21 06	32	14	17	0.008				
								8	9085 21 08	32	14	17	0.009
Probe without shut-off													

9285 Probe, Valved, with Barb Connection

	Nickel-plated brass, NBR		ØD	F	L	L1	L2	kg						
			5	4	9285 21 04	14	50	14	17	0.022				
				6	9285 21 06	14	50	14	17	0.023				
								8	9285 21 08	14	50	14	17	0.024
Probe with shut-off														

9095 Probe, Straight-Through, Bulkhead Mountable with Barb Connection

	Nickel-plated brass		ØD	F1	F2	L	L1	L2	L3	kg								
			5	4	9095 21 04	14	14	50	14	14	17	0.019						
				6	9095 21 06	14	17	50	14	14	17	0.027						
										8	9095 21 08	14	17	50	14	14	17	0.028
Probe without shut-off																		

Mini Series


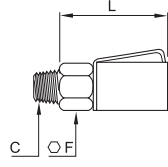








Single Shut-Off



Double Shut-Off


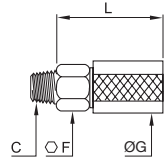









0171 Coupler, Male BSPT and Parallel Metric Thread

	Technical polymer, nickel-plated brass, NBR 		C		Colour	F	L	kg						
									M7x1	0171 02 55 01		10	21	0.007
									R1/8	0171 02 10 01		10	21	0.010
									R1/8	0171 02 10 02		10	21	0.010
									R1/8	0171 02 10 03		10	21	0.010
									R1/8	0171 02 10 04		10	21	0.010
									R1/8	0171 02 10 05		10	21	0.010


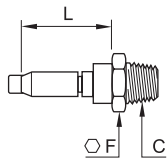


Single shut-off
Mini Series (DN 2): single shut-off = 165 Nl/min

0171 Coupler, Straight-Through, Male BSPT Thread

	Technical polymer, nickel-plated brass, NBR 		C		Colour	F	G	L	kg							
										R1/8	0171 03 10 01		13	17	24.5	0.020
										R1/8	0171 03 10 02		13	17	24.5	0.020
										R1/8	0171 03 10 03		13	17	24.5	0.020
										R1/8	0171 03 10 04		13	17	24.5	0.020
										R1/8	0171 03 10 05		13	17	24.5	0.020


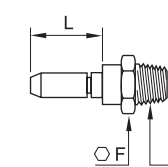


Straight-through

0183 Probe, Valved, Male BSPT Thread

	Nickel-plated brass, NBR 		C		F	L	kg


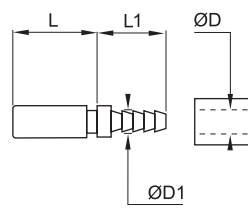


Probe with shut-off

0184 Probe, Straight-Through, Male BSPT Thread

	Nickel-plated brass 		C		F	L	kg

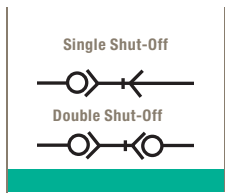
Probe without shut-off

0181 Probe without Shut-off, Male BSPT Thread

	Nickel-plated brass 		$\varnothing D$	$\varnothing D1$		L	L1	kg

Probe without shut-off

Mini Series



0181 Probe, Straight-Through with Barb Connection for Polyamide (PA) Tubing

	Nickel-plated brass		ØD ØD1	L	kg
			3 4 4.7 0181 04 06	19	0.005
Probe without shut-off					

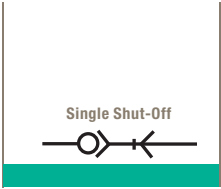
0180 Probe, Straight-Through with Barb Connection for Flexible Tubing

	Nickel-plated brass		ØD ØD1	L	kg
			3 4 6 0180 04 00	19	0.007
Probe without shut-off					
3 5 6.5 0180 05 00					


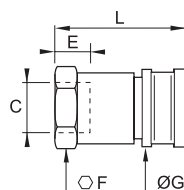


3150 Probe, Straight-Through with LF 3000® Push-In Connection

	Nickel-plated brass, NBR		ØD	G	L	L1	kg
			3 4 3150 00 61	8.5	39	18	0.008
Probe without shut-off							


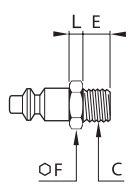


Standard Series




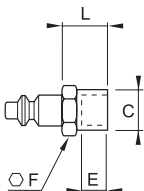


0172 Coupler, Female BSPP Thread

	Nickel-plated brass, NBR 	 C 	E	F	G	L	kg
		5 G1/4 0172 05 13	11	19	21	47	0.085
Standard series: single shut-off = 480 NI/min							


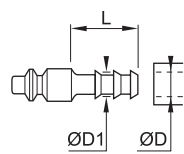


0187 Probe, Straight-Through, Male BSPP Thread

	Zinc-plated steel 	 C 	E	F	L	kg	
		5 G1/8 0187 05 10 G1/4 0187 05 13	7	14	4	0.018	
Probe without shut-off							


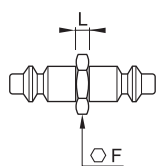


0186 Probe, Straight-Through, Female BSPP Thread

	Zinc-plated steel 	 C 	E	F	L	kg	
		5 G1/4 0186 05 13	12	17	17	0.028	
Probe without shut-off							

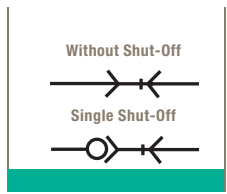
0185 Probe, Straight-Through, with Barb Connection for Flexible Tubing

	Zinc-plated steel 	 ØD ØD1 			L	kg	
		4 6 0185 04 00			22.5	0.014	
		5 7 9 0185 07 00 10 12.2 0185 10 00			22.5	0.017	
						22.5	0.014
Probe without shut-off							


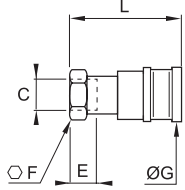


0189 Double Probe

	Zinc-plated steel 	 	F	L	kg
		5 0189 05 00	12	4	0.026
Probe without shut-off					


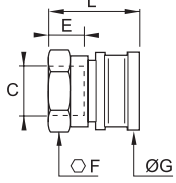


Midi Series




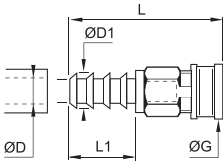


0172 Coupler, Female BSPP Thread

	Nickel-plated brass, NBR 		C		E	F	G	L	kg	
										12
Midi series: single shut-off = 2200 NI/min										


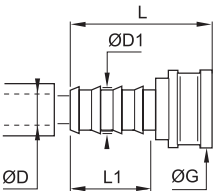


2272 Coupler, Straight-Through, Female BSPP Thread

	Nickel-plated brass, NBR 		C		E	F	G	L	kg


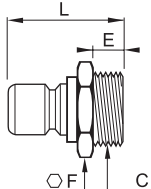


2511 Coupler with Barb Connection for Hose

	Nickel-plated brass, NBR 		ØD	ØD1		G	L	L1	kg	
										12
Midi series: single shut-off = 2200 NI/min										

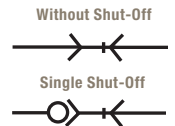
2297 Coupler, Straight-Through, with Barb Connection for Hose

	Nickel-plated brass, NBR 		ØD	ØD1		G	L	L1	kg

2294 Probe, Straight-Through, Male BSPP Thread

	Nickel-plated brass 		C		E	F	L	kg	
									12
Probe without shut-off									

Midi Series



0196 Probe, Straight-Through, Female BSPP Thread

	Nickel-plated brass		DN	C		E	F	L	kg
				G1/4	0196 12 13	12	17	16	0.027
			12	G3/8	0196 12 17	12	21	15	0.034
				G1/2	0196 12 21	14	26	17	0.050
Probe without shut-off									

2296 Probe, Straight-Through, Female BSPP Thread

	Nickel-plated brass		DN	C		E	G	L	kg
				G1/2	2296 12 21	11	24	31.5	0.031
			12	G3/4	2296 12 27	11	30	38	0.058
				G1	2296 12 34	11	36	36.5	0.058
Probe without shut-off									

0195 Probe, Straight-Through, with Barb Connection for Flexible Tubing

	Nickel-plated brass		DN	ØD	ØD1		F	L	kg
				7	9	0195 07 00	17	29.5	0.026
			12	10	12.2	0195 10 00	17	29.5	0.028
				13	15.2	0195 13 00	17	29.5	0.030
				16	18.5	0195 16 00	21	36.5	0.048
Probe without shut-off									

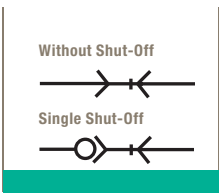
2295 Probe, Straight-Through, with Barb Connection for Flexible Hose

	Nickel-plated brass		DN	ØD	ØD1		G	L	L1	kg
				12	13.5	2295 12 12	17	48	27	0.026
			12	15	16.5	2295 12 15	18	48	27	0.034
				19	20.5	2295 12 19	24	57	33	0.053
Probe without shut-off										

2293 Y Coupler, Straight-Through

	Nickel-plated brass, NBR		DN		G	H	kg
			12	2293 12 00	29	27	0.139
Probe without shut-off Midi Series: straight-through = 2200 Nl/min							

Midi Series



2270 Coupler with Tap, Male BSPP Thread

	Nickel-plated brass, NBR			C		F	G	H	M	kg
			12	G1/2	2270 21 00	28	29	40.5	35	0.272
Flow = 2200 Nl/min										

2203 Plug

	Nickel-plated brass				G	L	kg
			12	2203 12 00	20	34	0.042

2292 Universal Coupler Adaptor

	Nickel-plated brass, NBR				G	L	kg
			12	2292 12 00	29	40.5	0.083
Without shut-off This adaptor provides interchangeability with numerous components (especially watering accessories).							

2398 Universal Probe Adaptor

	Nickel-plated brass, NBR				G	L	L1	L2	kg
			12	2398 12 01	20	43	19	18.5	0.035
This adaptor provides interchangeability with numerous components (especially watering accessories).									

2299 Water Pistol

	Zamak, Nickel-plated brass, NBR				H	L	kg
			12	2299 12 01	140	126	0.471
This pistol allows independent control of: - the flow rate (trigger) - type of jet (adjustable to a fine mist) by the adjustable Probe							

2299 Adjustable Nozzle


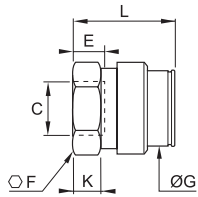


	Nickel-plated brass, NBR				L	kg
			12	2299 12 20	77.4	0.137
This nozzle allows adjustment of the spray.						

Maxi Series


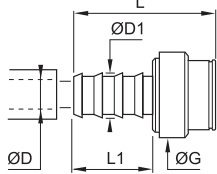


Without Shut-Off




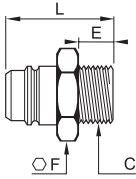


2272 Coupler, Straight-Through, Female BSSP Thread

	Nickel-plated brass, NBR 		C		E F G K L kg	
						19 G1 2272 18 34
Maxi series: straight-through = 8500 NI/min						


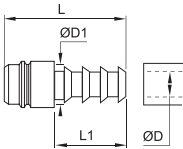


2297 Coupler, Straight-Through with Barb Connection for Hose

	Nickel-plated brass, NBR 		ØD ØD1		G L L1 kg	
						19 19 20.7 2297 18 20
Maxi series: straight-through = 8500 NI/min						

2294 Coupler, Straight-Through, Male BSSP Thread

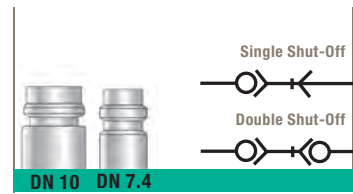
	Nickel-plated brass 		C		E F L kg	
						19 G3/4 2294 18 27 G1 2294 18 34
Probe without shut-off						

2295 Coupler, Straight-Through with Barb Connection for Flexible Hose

	Nickel-plated brass 		ØD ØD1		L L1 kg	
						19 19 21 2295 18 20
Probe without shut-off						

Stainless Steel European Profile

X25 and X27 Series



9201 Coupler, Male BSPP Thread

	Stainless steel 316L, FKM		DN	C		E	F	G	L	kg
			7.4	G1/4	9201X25 13	10.5	19	23	59	0.095
				G3/8	9201X25 17	9	19	23	57.5	0.094
				G1/2	9201X25 21	12	24	23	60.5	0.131
			10	G3/8	9201X27 17	9	24	27	57.5	0.131
				G1/2	9201X27 21	12	24	27	59.5	0.134
				G3/4	9201X27 27	16	32	27	60.5	0.171

X25 Series (DN 7.4): single shut-off = 1800 NI/min / X25 Series (DN 7.4): double shut-off = 710 NI/min
X27 Series (DN 10): single shut-off = 2400 NI/min / X27 Series (DN 10): double shut-off = 900 NI/min

9214 Coupler, Female BSPP Thread

	Stainless steel 316L, FKM		DN	C		E	F	G	L	kg
			7.4	G1/4	9214X25 13	10	19	23	56	0.096
				G3/8	9214X25 17	9	19	23	55	0.089
				G1/2	9214X25 21	12	24	23	58	0.119
			10	G3/8	9214X27 17	11	24	27	56	0.140
				G1/2	9214X27 21	12	24	27	56	0.127
				G3/4	9214X27 27	16	32	27	60	0.191

X25 Series (DN 7.4): single shut-off = 1800 NI/min / X25 Series (DN 7.4): double shut-off = 710 NI/min
X27 Series (DN 10): single shut-off = 2400 NI/min / X27 Series (DN 10): double shut-off = 900 NI/min

9287 Probe, Valved, Male BSPP Thread

	Stainless steel 316L, FKM		DN	C		E	F	L	L1	kg
			7.4	G1/4	9287X25 13	10	19	43	20	0.052
				G3/8	9287X25 17	9	19	43	20	0.053
				G1/2	9287X25 21	12	24	46	20	0.089
			10	G3/8	9287X27 17	9	24	58	22	0.080
				G1/2	9287X27 21	12	24	58	22	0.084
				G3/4	9287X27 27	16	32	62	22	0.122

Probe with shut-off

9087 Probe, Straight-Through, Male BSPP Thread

	Stainless steel 316L		DN	C		E	F	L	L1	kg
			7.4	G1/4	9087X25 13	9	17	34	20	0.018
				G3/8	9087X25 17	9	19	34	20	0.014
				G1/2	9087X25 21	12	24	36	20	0.047
			10	G3/8	9087X27 17	9	19	37	22	0.013
				G1/2	9087X27 21	12	24	40	22	0.052
				G3/4	9087X27 27	16	32	45	22	0.086

Probe without shut-off

9286 Probe, Valved, Female BSPP Thread

	Stainless steel 316L, FKM		DN	C		E	F	L	L1	kg
			7.4	G1/4	9286X25 13	10	19	54	20	0.056
				G3/8	9286X25 17	9	19	53	20	0.049
				G1/2	9286X25 21	12	24	56	20	0.079
			10	G3/8	9286X27 17	9	24	55	22	0.090
				G1/2	9286X27 21	12	24	55	22	0.080
				G3/4	9286X27 27	16	24	58	22	0.140

Probe with shut-off

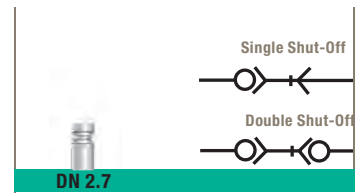
9086 Probe, Straight-Through, Female BSPP Thread

	Stainless steel 316L		DN	C		E	F	L	L1	kg
			7.4	G1/4	9086X25 13	12	10	33	20	0.023
				G3/8	9086X25 17	12	10	33	20	0.022
				G1/2	9086X25 21	14	12	35	20	0.035
			10	G3/8	9086X27 17	9	19	33	22	0.026
				G1/2	9086X27 21	12	24	37	22	0.037
				G3/4	9086X27 27	16	32	42	22	0.091

Probe without shut-off

Stainless Steel German Profile

X20 Series



9201 Coupler, Male BSPP and Metric Thread

	Stainless steel 316L, FKM		$\overline{\text{DN}}$	C		E	F	G	L	kg
			2.7	M5x0.8	9201X20 19	5	9	10	26	0.008
				G1/8	9201X20 10	7	11	10	28	0.011

X20 Series (DN 2.7) : single shut-off = 165 NI/min
X20 Series (DN 2.7) : double shut-off = 130 NI/min

9214 Coupler, Female BSPP and Metric Thread

	Stainless steel 316L, FKM		$\overline{\text{DN}}$	C		E	F	G	L	kg
			2.7	M5x0.8	9214X20 19	5	9	10	26	0.009
				G1/8	9214X20 10	7	12	10	28	0.012

X20 Series (DN 2.7) : single shut-off = 165 NI/min
X20 Series (DN 2.7) : double shut-off = 130 NI/min

9287 Probe, Valved, Male BSPP and Metric Thread

	Stainless steel 316L, FKM		$\overline{\text{DN}}$	C		E	F	L	L1	kg
			2.7	M5x0.8	9287X20 19	5	9	28	10	0.005
				G1/8	9287X20 10	7	11	30	10	0.009

Probe with shut-off

9087 Probe, Straight-Through, Male BSPP and Metric Thread

	Stainless steel 316L		$\overline{\text{DN}}$	C		E	F	L	L1	kg
			2.7	M5x0.8	9087X20 19	5	7	18	10	0.010
				G1/8	9087X20 10	7	11	20	10	0.015

Probe without shut-off

9286 Probe, Valved, Female BSPP and Metric Thread

	Stainless steel 316L, FKM		$\overline{\text{DN}}$	C		E	F	L	L1	kg
			2.7	M5x0.8	9286X20 19	5	9	26	10	0.010
				G1/8	9286X20 10	7	12	30	10	0.014

Probe with shut-off

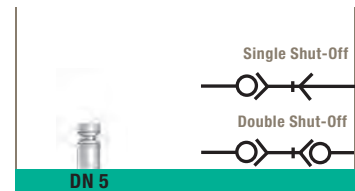
9086 Probe, Straight-Through, Female BSPP and Metric Thread

	Stainless steel 316L		$\overline{\text{DN}}$	C		E	F	L	L1	kg
			2.7	M5x0.8	9086X20 19	5	7	17	10	0.002
				G1/8	9086X20 10	7	12	19	10	0.005


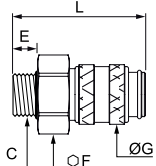

Probe without shut-off

Stainless Steel German Profile


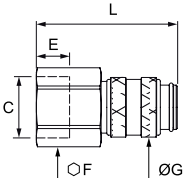

X21 Series




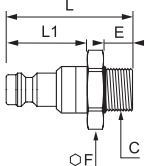

9201 Coupler, Male BSPP Thread

	Stainless steel 316L, FKM		DN	C		E	F	G	L	kg
			5	G1/8	9201X21 10	7	14	16	36	0.026
				G1/4	9201X21 13	9	17	16	38	0.034
X21 Series (DN 5): single shut-off = 560 NI/min X21 Series (DN 5): double shut-off = 310 NI/min										


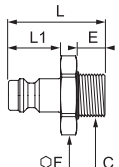

9214 Coupler, Female BSPP Thread

	Stainless steel 316L, FKM		DN	C		E	F	G	L	kg
			5	G1/8	9214X21 10	9	14	16	36	0.027
				G1/4	9214X21 13	9	17	16	38	0.037
X21 Series (DN 5): single shut-off = 560 NI/min X21 Series (DN 5): double shut-off = 310 NI/min										


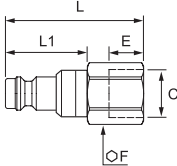

9287 Probe, Valved, Male BSPP Thread

	Stainless steel 316L, FKM		DN	C		E	F	L	L1	kg
			5	G1/8	9287X21 10	7	14	40	14	0.021
				G1/4	9287X21 13	9	17	42	14	0.030
Probe with shut-off										


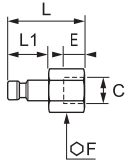

9087 Probe, Straight-Through, Male BSPP Thread

	Stainless steel 316L		DN	C		E	F	L	L1	kg
			5	G1/8	9087X21 10	7	14	25	14	0.011
				G1/4	9087X21 13	9	17	28	14	0.018
Probe without shut-off										

9286 Probe, Valved, Female BSPP Thread

	Stainless steel 316L, FKM		DN	C		E	F	L	L1	kg
			5	G1/8	9286X21 10	7	14	40	14	0.024
				G1/4	9286X21 13	9	17	42	14	0.033
Probe with shut-off										

9086 Probe, Straight-Through, Female BSPP Thread

	Stainless steel 316L		DN	C		E	F	L	L1	kg
			5	G1/8	9086X21 10	8	14	25	14	0.013
				G1/4	9086X21 13	9	17	25	14	0.017
Probe without shut-off										

Quick-Acting Mould Couplers

These Parker Legris quick-acting couplers provide the **best compromise** between **technical performance and ease of use** while providing long-term, reliable temperature regulation.

Product Advantages

- Ergonomic**
 - Can be connected using one hand by simply pushing the coupler body into the socket
 - Knurled sleeve provides excellent grip
 - Compact
- Performance**
 - Direct and automatic sealing
 - Socket threads are pre-coated
 - Maximum flow rate

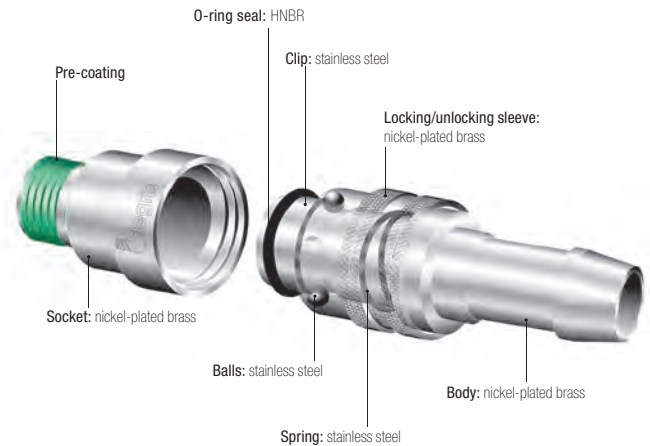


- Applications**
- Plastic Injection Moulding
 - Cooling
 - Die-Casting
 - Rubber Overmoulding
 - Printing
 - Coating & Laminating

Technical Characteristics

Compatible Fluids	Cold water, coolants, hot water, oil
Working Pressure	0 to 10 bar
Working Temperature	-15°C to +90°C (water applications) <i>For temperatures above 90°C, please contact us.</i>

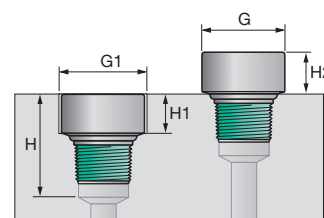
Component Materials



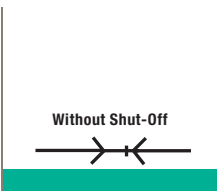
Installation

Cavity Dimensions


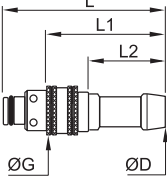


	G	G1	H	H1	H2
9075T08 10	21	22	33	24	22
9075T08 13	21	22	34	24	22
9075T08 17	21	22	25	13	11
9075T12 17	32	33	42	30	28
9075T12 21	32	33	45	30	28




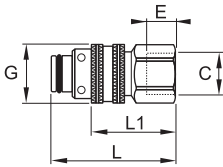


Quick-Acting Mould Couplers




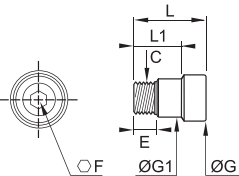


9020 Coupler with Hosetail

	Nickel-plated brass, HNBR 		ØD		G	L	L1	L2	kg
			8						
			10	9020T08 10	21	60	44	28	0.054
			12	9020T08 12	21	65	48	32	0.063
			12	13	32	75	53	32	0.069
			16	9020T12 16	32	75.5	54	32.5	0.172

9040 Coupler, Female BSPP Thread

	Nickel-plated brass, HNBR 		C		E	G	L	L1	kg	
										8
			12	G1/2	9040T12 21	15	32	66	44	0.208

9075 Female Socket, Male BSPT Thread

	Nickel-plated brass 		C		E	F	G	G1	L	L1	kg	
												8
			8	R1/4	9075T08 13	13	8	21	17.5	33	22	0.031
				R3/8	9075T08 17	13	8	21	-	24	-	0.023
			12	R3/8	9075T12 17	13	10	32	25	41	27	0.073
				R1/2	9075T12 21	16	14	32	25	44	30	0.075

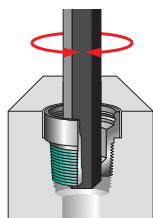
Other coupler shapes are available on request:

- 90° angled body, with hosetail
- 45° angled body, female BSPP
- 90° angled body, female BSPP



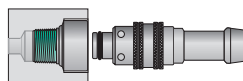
Socket Installation

Two types of installation can be used for moulds. Sockets are fitted into the cavities using an Allen key.



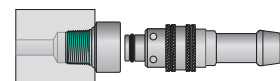
Recessed Socket

This type of installation is recommended for new moulds



Exposed Socket

This type of installation is suited to moulds with no existing cavity.



Metal Quick-Acting Coupler Accessories

Parker Legris has developed a range of accessories for quick-acting couplers which save time, **match the product** to the application and **increase the life** of the equipment.

Product Advantages

Performance | Interchangeability with ISO B probe profile
 Avoids tube twisting
 Facilitates use by following movements
 Robust

Adaptable | Two models depending on the application:
 Oscillating fittings:
 • angled at 45° and fitted with a ball bearing
 • effortless rotation through 360°
 Flexible fittings:
 • fitted with a ball joint mounted on a lubricated plastic seat
 • single connection providing an angle of rotation of 70°
 • multiple tees (three connections) providing an angle of rotation of 360°



Pneumatics
 Water
 Workshops
 Industrial Machinery

Applications

Technical Characteristics

Compatible Fluids	Industrial fluids
Working Pressure	Oscillating fittings: 0 to 15 bar Flexible fittings: 0 to 10 bar Swivelling multiple tees: 0 to 20 bar
Working Temperature	-5°C to +60°C

Component Materials




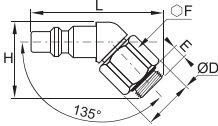


Other accessories are available on request:

- ISO B rotary fitting, male BSPT
- ISO B jointed fitting, male BSPP
- multiple tee with 2 outlets, female male BSPP



Metal Quick-Acting Coupler Accessories

9071U Oscillating ISO B Probe, Male BSPP Thread


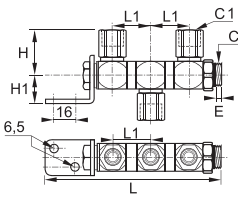

	Treated steel, NBR 	 C 	E	F	H	L	kg
		6 G1/4 9071U06 13	5.5	19	30	52	0.066
		8 G1/4 9071U08 13	5.5	19	30	52	0.077

0691 Flexible Fitting, Female/Male BSPP Thread


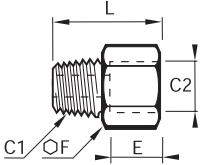

	Treated steel, NBR 	 C 	E	F	G	L	kg
		5.5 G1/4 0691 13 13	5.5	24	25.5	56	0.090

NBR sleeve

0681 Multiple Tee with 3 Female Outlets, Male/Female BSPP Thread


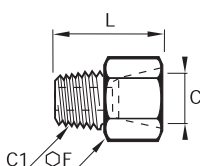

	Chrome-plated brass, NBR 	C	C1		E	H	H1	L	L1	kg
		G1/2	G1/4	0681 13 21	7.5	36	24	138.5	30	0.430

0164 Adaptor, Male NPT/Female BSPP Thread

	Brass 	C1	C2		E	F	L	kg
		NPT1/8	G1/8	0164 11 10	7.5	14	20	0.015
		NPT1/4	G1/4	0164 14 13	11	17	27.5	0.028
		NPT3/8	G3/8	0164 18 17	11.5	22	28.5	0.044
		NPT1/2	G1/2	0164 22 21	15	27	36.5	0.082
		NPT3/4	G3/4	0164 28 27	16.5	32	38.5	0.110

Adaptor for female socket of quick-acting mould couplers

0167 Adaptor, Male BSPT/Female NPT Thread

	Brass 	C1	C2		F	L	kg
		R1/8	NPT1/8	0167 10 11	14	21	0.016
		R1/4	NPT1/4	0167 13 14	17	28.5	0.029
		R3/8	NPT3/8	0167 17 18	22	29.5	0.047
		R1/2	NPT1/2	0167 21 22	27	37.5	0.088
		R3/4	NPT3/4	0167 27 28	32	39.5	0.120

Adaptor for female socket of quick-acting mould couplers

Adaptors and Manifolds



PARKER LEGRIS Industrial Connector Systems

Products are available from

MARYLAND METRICS

P.O. Box 261 Owings Mills, MD 21117 USA email: sales@mdmetric.com

ph: (410)358-3130 (800)638-1830 fx: (410)358-3142 (800)872-9329

web: http://mdmetric.com RFQ form: http://mdmetric.com/rfq.htm

How to order: Please preface each PARKER LEGRIS Catalog part number with 'R053-' Example: R053-3175 04 10



A Complete Range of Adaptors

Brass Adaptors

- | | | | | | | | | | | | |
|---------------------------------|--------------------------------------|---------------------------------|---------------------------------|--------------------------------------|---------------------------------|---------------------------------|-------------------------------------|-------------------------------------|---------------------------------|--------------------------------------|---------------------------------|
| 0143
BSPP
Page 9-7 | 0144
BSPT/BSPP
Page 9-7 | 0152
BSPT
Page 9-7 | 0145
BSPP
Page 9-7 | 0158
BSPT/BSPP
Page 9-7 | 0117
BSPP
Page 9-8 | 0155
BSPP
Page 9-8 | 0164
NPT/BSPP
Page 9-8 | 0167
BSPT/NPT
Page 9-8 | 0168
BSPP
Page 9-9 | 0163
BSPT/BSPP
Page 9-9 | 0169
BSPP
Page 9-9 |
|---------------------------------|--------------------------------------|---------------------------------|---------------------------------|--------------------------------------|---------------------------------|---------------------------------|-------------------------------------|-------------------------------------|---------------------------------|--------------------------------------|---------------------------------|

- | | | | | |
|-------------------------------------|---------------------------------|----------------------------------|----------------------------------|----------------------------------|
| 0121
NPT/BSPT
Page 9-9 | 0121
BSPT
Page 9-9 | 0929
BSPT
Page 9-10 | 0123
BSPT
Page 9-10 | 0136
BSPT
Page 9-11 |
|-------------------------------------|---------------------------------|----------------------------------|----------------------------------|----------------------------------|

Nickel-Plated Brass Adaptors

- | | | | | | | | | | | | |
|---|------------------------------------|---------------------------------------|------------------------------------|----------------------------------|----------------------------------|---------------------------------------|---|------------------------------------|---------------------------------------|------------------------------------|---------------------------------------|
| 0912
BSPP/Metric
Page 9-11 | 0921
Metric
Page 9-11 | 0913
BSPT/BSPP
Page 9-11 | 0922
Metric
Page 9-11 | 0914
BSPT
Page 9-11 | 0910
BSPP
Page 9-12 | 0911
BSPT/BSPP
Page 9-12 | 0915
BSPP/Metric
Page 9-12 | 0923
Metric
Page 9-12 | 0916
BSPT/BSPP
Page 9-12 | 0924
Metric
Page 9-13 | 0917
BSPT/BSPP
Page 9-14 |
|---|------------------------------------|---------------------------------------|------------------------------------|----------------------------------|----------------------------------|---------------------------------------|---|------------------------------------|---------------------------------------|------------------------------------|---------------------------------------|

- | | | | | | | | | | | | |
|----------------------------------|---------------------------------------|---------------------------------------|----------------------------------|---------------------------------------|----------------------------------|---------------------------------------|---|---|----------------------------------|---|----------------------------------|
| 0927
BSPT
Page 9-13 | 0928
BSPT/BSPP
Page 9-13 | 0932
BSPT/BSPP
Page 9-13 | 0908
BSPP
Page 9-14 | 0909
BSPT/BSPP
Page 9-14 | 0903
BSPP
Page 9-14 | 0904
BSPT/BSPP
Page 9-14 | 0905
BSPP/Metric
Page 9-14 | 0906
BSPP/Metric
Page 9-15 | 0907
BSPP
Page 9-15 | 0920
BSPP/Metric
Page 9-15 | 0900
BSPT
Page 9-17 |
|----------------------------------|---------------------------------------|---------------------------------------|----------------------------------|---------------------------------------|----------------------------------|---------------------------------------|---|---|----------------------------------|---|----------------------------------|

- | | | | | |
|---|---------------------------------------|---|----------------------------------|----------------------------------|
| 0901
BSPP/Metric
Page 9-16 | 0192
BSPT/BSPP
Page 9-16 | 0902
BSPP/Metric
Page 9-16 | 0191
BSPP
Page 9-16 | 0931
BSPP
Page 9-17 |
|---|---------------------------------------|---|----------------------------------|----------------------------------|

Stainless Steel Adaptors

- | | | | | | | | | | | | |
|---------------------------------------|----------------------------------|----------------------------------|----------------------------------|---------------------------------|----------------------------------|---------------------------------|----------------------------------|--------------------------------------|--------------------------------------|---------------------------------------|---------------------------------|
| 1844
BSPT/BSPP
Page 9-18 | 1843
BSPP
Page 9-18 | 1845
BSPP
Page 9-18 | 1817
BSPP
Page 9-18 | 1871
NPT
Page 9-18 | 1855
BSPP
Page 9-19 | 1870
NPT
Page 9-19 | 1862
BSPP
Page 9-19 | 1864
NPT/BSPP
Page 9-19 | 1867
BSPT/NPT
Page 9-19 | 1863
BSPT/BSPP
Page 9-20 | 1872
NPT
Page 9-20 |
|---------------------------------------|----------------------------------|----------------------------------|----------------------------------|---------------------------------|----------------------------------|---------------------------------|----------------------------------|--------------------------------------|--------------------------------------|---------------------------------------|---------------------------------|

- | | | | | | |
|---------------------------------------|---------------------------------|----------------------------------|---------------------------------|----------------------------------|---------------------------------|
| 1861
BSPT/BSPP
Page 9-20 | 1873
NPT
Page 9-20 | 1821
BSPT
Page 9-20 | 1821
NPT
Page 9-21 | 1823
BSPT
Page 9-21 | 1823
NPT
Page 9-21 |
|---------------------------------------|---------------------------------|----------------------------------|---------------------------------|----------------------------------|---------------------------------|

A Complete Range of Manifolds, Plugs and Accessories

Brass and Aluminium Manifolds

0135 BSPP brass Page 9-22	3310 Push-In Page 9-23	3311 BSPP/Metric Page 9-23	3312 BSPP/Metric Page 9-23	3313 BSPP Page 9-23	3301 Modular Page 9-24	3302 Single, double and triple Page 9-24	3303 Elbow Page 9-25	3303 Plug Page 9-25

Brass Plugs

0205 BSPT Page 9-26	0205 NPT Page 9-26	0209 BSPT Page 9-26	0220 BSPP/Metric Page 9-26	0200 BSPP/Metric Page 9-26	0201 BSPP/Metric Page 9-27	0202 Metric Page 9-27

Nickel-Plated Brass Hollow Hex Plug

0919
BSPP/Metric
Page 9-28



Steel Plugs

0206 BSPT Page 9-29	0206 NPT Page 9-29	0210 BSPP/Metric Page 9-29	0216 BSPT Page 9-29	0216 NPT Page 9-29

Stainless Steel Plugs

0285 BSPT Page 9-30	0285 NPT Page 9-30

Sealing Accessories

0138 Page 9-31	0137 Page 9-31	0605 Page 9-32	0602 Page 9-32	0139 Page 9-32

Tube Supports

0127 Brass Page 9-33	1827 Stainless Steel Page 9-33

Adaptors, Plugs and Manifolds

Parker Legris offers a **wide range of adaptors and manifolds** compatible with the various Parker Legris fitting systems. This range of products provides the user with a **complete solution** covering numerous applications, both in non-corrosive and corrosive environments.

Product Advantages

Large Range & Flexibility

A complete offer, from the simple adaptor to a modular manifold solution

Large selection of materials for excellent chemical compatibility: brass, steel, stainless steel, aluminium

Surface treatment for increased corrosion resistance: nickel-plated brass or anodised aluminium

Stainless steel for corrosive environments

BSPP, BSPT, NPT and metric threads

Performance

Robust design

Suitable for low to high pressure, depending on configuration and material

Forged shapes for mechanical strength



Packaging
Robotics
Textile
Pneumatics
Automotive Process
Food Process


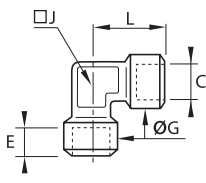

Applications

Technical Characteristics


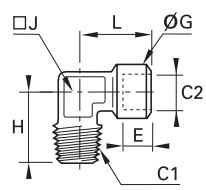

Products	Adaptors and Plugs				Manifolds
Component Materials	Brass	Nickel-plated brass	Stainless steel 316L	Steel	Anodised aluminium
Working Pressure	1/8" to 1/2": 200 bar 3/4" and 1": 150 bar 1 1/4" to 2": 100 bar, without sealing washer	60 bar	1/8" to 1/2": 200 bar 3/4" and 1": 150 bar 1 1/4" to 2": 100 bar, without sealing washer	1/8" to 1/2": 200 bar 3/4" and 1": 150 bar 1 1/4" to 2": 100 bar, without sealing washer	20 bar
Working Temperature	-40°C to +150°C without sealing washer -20°C to +80°C with sealing washer	-10°C to +80°C	-20°C to +180°C	-10°C to +80°C	-10°C to +80°C

Brass Adaptors


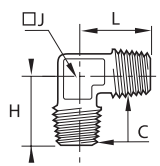

0143 Equal Threaded Elbow, Female BSPP Thread

		C		E	G	J	L	kg
		G1/8	0143 10 10	7.5	16.5	12	22.5	0.044
		G1/4	0143 13 13	11	18.5	15	26.5	0.055
		G3/8	0143 17 17	11.5	23.5	19	31.5	0.100
		G1/2	0143 21 21	15	28	23	34.5	0.150
		G3/4	0143 27 27	16.5	34	27	43.5	0.242


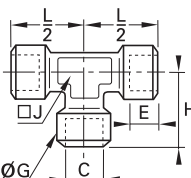

0144 Equal Stud Elbow, Male BSPT/Female BSPP Thread

		C1	C2		E	G	H	J	L	kg
		R1/8	G1/8	0144 10 10	7.5	16.5	23	12	22.5	0.036
		R1/4	G1/4	0144 13 13	11	18.5	26	15	26.5	0.054
		R3/8	G3/8	0144 17 17	11.5	23.5	30	19	31.5	0.088
		R1/2	G1/2	0144 21 21	15	28	35	23	34.5	0.140
		R3/4	G3/4	0144 27 27	16.5	34	40	27	43.5	0.228


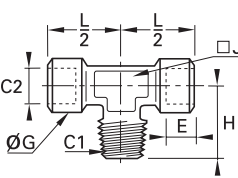

0152 Equal Elbow, Male BSPT Thread

		C		H	J	L	kg
		R1/8	0152 10 10	19.5	10	19.5	0.017
		R1/4	0152 13 13	25	15	25	0.045
		R3/8	0152 17 17	26.5	15	26.5	0.055
		R1/2	0152 21 21	31.5	19	31.5	0.088
		R3/4	0152 27 27	35.5	23	35.5	0.153

0145 Equal Tee, Female BSPP Thread

		C		E	G	H	J	L/2	kg
		G1/8	0145 10 10	7.5	16.5	22.5	12	22.5	0.056
		G1/4	0145 13 13	11	18.5	26.5	15	26.5	0.083
		G3/8	0145 17 17	11.5	23.5	31	19	31	0.131
		G1/2	0145 21 21	15	28	38	23	38	0.242
		G3/4	0145 27 27	16.5	34	47.5	27	47.5	0.378

0158 Stud Branch Tee, Male BSPT/Female BSPP Thread

		C1	C2		E	G	H	J	L/2	kg
		R1/8	G1/8	0158 10 10	7.5	16.5	21.5	12	21.5	0.046
		R1/4	G1/4	0158 13 13	11	18.5	26	15	26	0.074
		R3/8	G3/8	0158 17 17	11.5	23.5	30	19	30	0.120
		R1/2	G1/2	0158 21 21	15	28	36	23	36	0.205
		R3/4	G3/4	0158 27 27	16.5	34	44	27	44	0.310

Brass Adaptors

0117 Equal Bulkhead Coupling, Female BSPP and Metric Thread

		C		F	F1	K_{max}	L	L1	ØT	kg
		M5x0.8	0117 00 19	14	14	7	10.5	3.5	10.5	0.012
		G1/8	0117 00 10	19	22	9	14	4	16.5	0.033
		G1/4	0117 00 13	24	27	15	21	4	20.5	0.057
		G3/8	0117 00 17	30	32	14	21	5	26.5	0.096
		G1/2	0117 00 21	32	36	20	27	6	28.5	0.116
		G3/4	0117 00 27	41	41	22.5	30	6	34.5	0.161
		G1	0117 00 34	46	50	24.5	34	8	42.5	0.266
		G1 1/4	0117 00 42	55	55	29.5	39	8	49.5	0.299
		G1 1/2	0117 00 49	60	60	29.5	39	8	54.5	0.303

0155 Equal Connector, Female BSPP Thread

		C		F	L	kg
		G1/8	0155 10 10	14	17	0.014
		G1/4	0155 13 13	17	24	0.026
		G3/8	0155 17 17	22	25	0.046
		G1/2	0155 21 21	27	32	0.084
		G3/4	0155 27 27	32	35	0.109

0164 Adaptor, Male NPT/Female BSPP Thread

		C1	C2		E	F	L	kg
		NPT1/8	G1/8	0164 11 10	7.5	14	20	0.015
		NPT1/4	G1/4	0164 14 13	11	17	27.5	0.028
		NPT3/8	G3/8	0164 18 17	11.5	22	28.5	0.044
		NPT1/2	G1/2	0164 22 21	15	27	36.5	0.082
		NPT3/4	G3/4	0164 28 27	16.5	32	38.5	0.110

0167 Adaptor, Male BSPT/Female NPT Thread

		C1	C2		F	L	kg
		R1/8	NPT1/8	0167 10 11	14	21	0.016
		R1/4	NPT1/4	0167 13 14	17	28.5	0.029
		R3/8	NPT3/8	0167 17 18	22	29.5	0.047
		R1/2	NPT1/2	0167 21 22	27	37.5	0.088
		R3/4	NPT3/4	0167 27 28	32	39.5	0.120


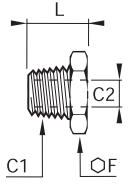

0168 Reducer, Male BSPP/Female BSPP and Metric Thread

		C1	C2		E	F	H	kg
		G1/8	M5x0.8	0168 10 19	7	14	6	0.009
		G1/4	M5x0.8	0168 13 19	7	17	7	0.017
		G1/8	G1/8	0168 13 10	7	17	7	0.011
		G3/8	G1/8	0168 17 10	9	19	6	0.019
		G1/4	G1/4	0168 17 13	9	19	6	0.013
		G1/8	G1/8	0168 21 10	11	24	10	0.050
		G1/2	G1/4	0168 21 13	11	24	10	0.041
		G3/8	G3/8	0168 21 17	11	24	10	0.029
		G1/4	G1/4	0168 27 13	11	32	12	0.098
		G3/4	G3/8	0168 27 17	11	32	12	0.083
		G1/2	G1/2	0168 27 21	11	32	12	0.063


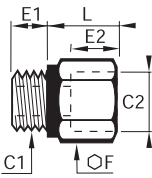

With fitted captive seal

Brass Adaptors

0163 Unequal Reducer, Male BSPT/Female BSPP Thread


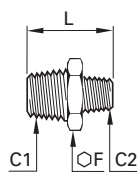

	Brass		C1	C2		F	L	kg
			R1/4	G1/8	0163 13 10	14	16	0.009
			G1/8	0163 17 10	17	16.5	0.020	
			G1/4	0163 17 13	17	16.5	0.012	
			G1/8	0163 21 10	22	21	0.048	
			G1/4	0163 21 13	22	21	0.038	
			G3/8	0163 21 17	22	21	0.024	
			G1/4	0163 27 13	27	24	0.084	
			G3/8	0163 27 17	27	24	0.069	
			G1/2	0163 27 21	27	24	0.046	

0169 Increaser, Male/Female BSPP Thread


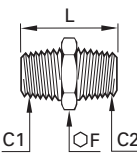

	Brass, technical polymer		C1	C2		E1	E2	F	L	kg
			G1/8	G1/4	0169 10 13	5	11	17	16	0.019
			G3/8	0169 10 17	5	14	22	19.5	0.039	
			G3/8	0169 13 17	7	14	22	19.5	0.041	
			G1/2	0169 13 21	7	14.5	27	20.5	0.062	
			G1/2	0169 17 21	8	14.5	27	20.5	0.062	
			G3/4	0169 17 27	8	15.5	32	22	0.082	
			G1/2	0169 21 27	9.5	15.5	32	22.5	0.087	

With fitted captive seal

0121 Straight Male Adaptor, Male BSPT Thread


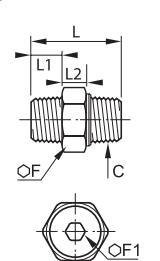

	Brass		C1	C2		F	L	kg
			R1/8	R1/8	0121 10 10	11	19	0.009
			R1/8	0121 13 10	14	23.5	0.017	
			R1/4	0121 13 13	14	27	0.020	
			R1/8	0121 17 10	17	24	0.021	
			R1/4	0121 17 13	17	27.5	0.025	
			R3/8	0121 17 17	17	28	0.026	
			R1/8	0121 21 10	22	28.5	0.042	
			R1/4	0121 21 13	22	32	0.045	
			R3/8	0121 21 17	22	32.5	0.045	
			R1/2	0121 21 21	22	36	0.052	
			R1/4	0121 27 13	27	35	0.078	
			R3/8	0121 27 17	27	35.5	0.078	
			R1/2	0121 27 21	27	39	0.085	
			R3/4	0121 27 27	27	40	0.091	
			R3/8	0121 34 17	36	38.5	0.127	
			R1/2	0121 34 21	36	42	0.134	
			R3/4	0121 34 27	36	43	0.143	
			R1	0121 34 34	36	46	0.154	
			R1/2	0121 42 21	46	46.5	0.220	
			R3/4	0121 42 27	46	47.5	0.224	
			R1	0121 42 34	46	50.5	0.239	
			R1 1/4	0121 42 42	46	53	0.230	

0121 Equal Adaptor, Male NPT/BSPT Thread

	Brass		C1	C2		F	L	kg
			NPT1/8	R1/8	0121 11 10	11	19	0.009
			NPT1/4	R1/4	0121 14 13	14	27	0.021
			NPT3/8	R3/8	0121 18 17	17	28	0.026
			NPT1/2	R1/2	0121 22 21	22	36	0.052
			NPT3/4	R3/4	0121 28 27	27	40	0.090


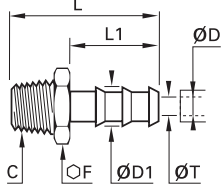

Brass Adaptors

0929 Equal 3-Piece Adaptor, Male BSPT Thread


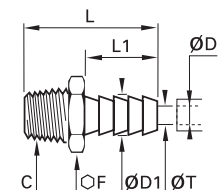

	Brass, NBR 	C		F	F1	L	L1	L2	kg
		R1/8	0929 01 10	15	5	27	9	8.5	0.017
		R1/4	0929 01 13	19	6	33.5	11.5	9.5	0.035
		R3/8	0929 01 17	22	8	36.5	13	10	0.054
		R1/2	0929 01 21	27	12	45	15.5	12	0.088

This connection accessory makes assembly much easier thanks to its 3-piece design.
 To join 2 threaded components, simply push together and tighten the sleeve nut, thus reducing installation time.
 Maximum working pressure: 50 bar
 Working temperature: -10° to +80°C
 Supplied with seal

0123 Tailpiece Adaptor for Rubber Hose, Male BSPT Thread


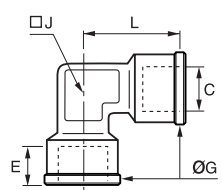

	Brass 	ØD	ØD1	C		F	L	L1	ØT	kg
		4	6	R1/8	0123 04 10	10	34	22.5	3.3	0.008
		6	8	R1/8	0123 06 10	10	34	22.5	5	0.009
		7	9	R1/8	0123 07 10	10	34	22.5	5	0.009
			9	R1/4	0123 07 13	14	38.5	22.5	6	0.018
		10	9	R3/8	0123 07 17	17	39	22.5	6	0.023
			12.2	R1/8	0123 10 10	13	34	22.5	5	0.014
			12.2	R1/4	0123 10 13	14	38.5	22.5	7	0.020
		12	12.2	R3/8	0123 10 17	17	39	22.5	9.5	0.023
			14	R3/8	0123 12 17	17	46	29.5	11	0.026
			15	R1/4	0123 13 13	17	45.5	29.5	7	0.026
		13	15	R3/8	0123 13 17	17	46	29.5	11	0.027
			15	R1/2	0123 13 21	22	50.5	29.5	12	0.045
		16	18.5	R3/8	0123 16 17	19	54.5	38	11	0.040
			18.5	R1/2	0123 16 21	22	59	38	14	0.054
			18.5	R3/4	0123 16 27	27	62	38	15	0.084
		19	21.5	R3/8	0123 19 17	22	54.5	38	11	0.046
			21.5	R1/2	0123 19 21	22	59	38	14	0.056
			21.5	R3/4	0123 19 27	27	62	38	18	0.082
		25	26.7	R3/4	0123 25 27	27	62	38	18	0.079
			27	R1	0123 25 34	36	65	38	24	0.124
		32	34.5	R1	0123 32 34	36	70	43	24	0.141

0136 Tailpiece Adaptor for Flexible Tubing, Male BSPT Thread


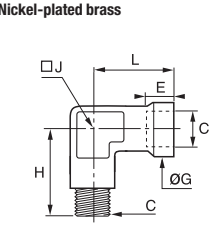

	Brass 	ØD	ØD1	C		F	L	L1	ØT	kg
		4	4.3	R1/8	0136 06 10	10	26.5	15	2	0.007
			4.3	R1/4	0136 06 13	14	31	15	2	0.015
			4.3	R3/8	0136 06 17	17	31.5	15	2	0.020
		6	6.4	R1/8	0136 08 10	10	26.5	15	4	0.007
			6.4	R1/4	0136 08 13	14	31	15	4	0.015
		8	6.4	R3/8	0136 08 17	17	31.5	15	4	0.020
			8.4	R1/4	0136 10 13	14	31	15	6	0.016
			8.4	R3/8	0136 10 17	17	31.5	15	6	0.020
		10	8.4	R1/2	0136 10 21	22	36	15	6	0.039
			10.7	R1/4	0136 12 13	14	36	20	7	0.018
			10.7	R3/8	0136 12 17	17	36.5	20	8	0.023
			10.7	R1/2	0136 12 21	22	41	20	8	0.041
			12.7	R1/4	0136 14 13	14	36	20	7	0.019
		12	12.7	R3/8	0136 14 17	17	36.5	20	10	0.023
			12.7	R1/2	0136 14 21	22	41	20	10	0.040
			12.7	R3/4	0136 14 27	27	44	20	10	0.071
		13	13.7	R3/8	0136 16 17	17	36.5	20	11	0.023
			13.7	R1/2	0136 16 21	22	41	20	11	0.041
		13.7	R3/4	0136 16 27	27	44	20	11	0.070	

Nickel-Plated Brass Adaptors


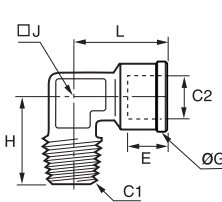

0912 Equal Stud Elbow, Female BSPP and Metric Thread

	Nickel-plated brass		C		E	G	J	L	kg
			M5x0.8	0912 00 19	4	8	9	11	0.006
			G1/8	0912 00 10	8	13	10	18.5	0.015
			G1/4	0912 00 13	11	17	12	22.5	0.028
			G3/8	0912 00 17	11.5	21	15	25.5	0.043
			G1/2	0912 00 21	14	26	19	30	0.073
			G3/4	0912 00 27	16.5	32	22	35.5	0.143
			G1	0912 00 34	18	38.5	28	40.5	0.166


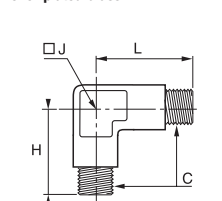

0921 Equal Stud Elbow, Male/Female and Metric Thread

	Nickel-plated brass		C1	C2		E	G	H	J	L	kg
			M5x0.8	M5x0.8	0921 00 19	4	8	11	9	11	0.006


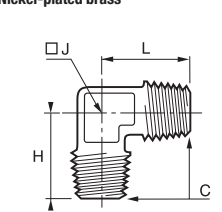

0913 Equal Stud Elbow, Male BSPT/ Female BSPP Thread

	Nickel-plated brass		C1	C2		E	G	H	J	L	kg
			R1/8	G1/8	0913 00 10	8	13	17	10	18.5	0.012
			R1/4	G1/4	0913 00 13	11	17	22.5	12	22.5	0.026
			R3/8	G3/8	0913 00 17	11.5	21	25.5	15	25.5	0.038
			R1/2	G1/2	0913 00 21	14	26	30	19	30	0.064
			R3/4	G3/4	0913 00 27	16.5	32	34.5	22	35.5	0.098
			R1	G1	0913 00 34	18	38.5	40.5	28	40.5	0.000

0922 Equal Stud Elbow, Male Metric Thread


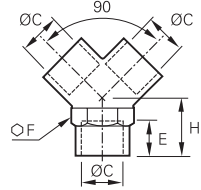

	Nickel-plated brass		C		H	J	L	kg
			M5x0.8	0922 00 19	11	9	11	0.010

0914 Equal Stud Elbow, Male BSPT Thread


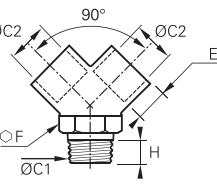

	Nickel-plated brass		C		H	J	L	kg
			R1/8	0914 00 10	17	10	17	0.012
			R1/4	0914 00 13	22.5	12	22.5	0.027
			R3/8	0914 00 17	25.5	15	25.5	0.035
			R1/2	0914 00 21	30	19	30	0.056
			R3/4	0914 00 27	34.5	22	34.5	0.104
			R1	0914 00 34	40.5	28	40.5	0.156

Nickel-Plated Brass Adaptors


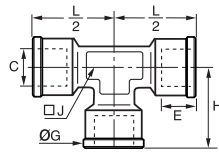

0910 Equal Y, Female BSPP Thread

	Nickel-plated brass 	C		E	F	H	kg
		G1/8	0910 00 10	8	13	12	0.018
		G1/4	0910 00 13	11	17	14	0.033
		G3/8	0910 00 17	11.5	20	16	0.045
		G1/2	0910 00 21	14	25	19	0.083


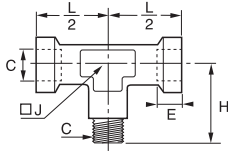

0911 Equal Y, Male BSPT/Female BSPP Thread

	Nickel-plated brass 	C1	C2		E	F	H	kg
		R1/8	G1/8	0911 00 10	8	13	12	0.022
		R1/4	G1/4	0911 00 13	11	17	14	0.038
		R3/8	G3/8	0911 00 17	11.5	20	16	0.050
		R1/2	G1/2	0911 00 21	14	25	19	0.103


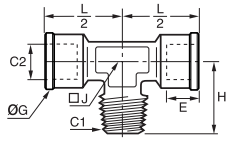

0915 Equal Tee, Female BSPP and Metric Thread

	Nickel-plated brass 	C		E	G	H	J	L/2	kg
		M5x0.8	0915 00 19	4	8	11	9	11	0.010
		G1/8	0915 00 10	8	13	18.5	10	18.5	0.021
		G1/4	0915 00 13	11	17	22.5	12	22.5	0.042
		G3/8	0915 00 17	11.5	21	25.5	15	25.5	0.062
		G1/2	0915 00 21	14	26	30	19	30	0.099
		G3/4	0915 00 27	16.5	32	35.5	22	35.5	0.143
		G1	0915 00 34	18	38.5	40	28	40	0.244

0923 Equal Stud Branch Tee, Female/Male Metric Thread

	Nickel-plated brass 	C1	C2		E	G	H	J	L/2	kg
		M5x0.8	M5x0.8	0923 00 19	4	8	11	9	11	0.009

0916 Equal Stud Branch Tee, Male BSPT/Female BSPP Thread

	Nickel-plated brass 	C1	C2		E	G	H	J	L/2	kg
		R1/8	G1/8	0916 00 10	8	13	17	10	18.5	0.019
		R1/4	G1/4	0916 00 13	11	17	23.5	13	22.5	0.038
		R3/8	G3/8	0916 00 17	11.5	21	25.5	15	25.5	0.076
		R1/2	G1/2	0916 00 21	14	26	30	19	30	0.091
		R3/4	G3/4	0916 00 27	16.5	32	34.5	22	35.5	0.140
		R1	G1	0916 00 34	18	38.5	40.5	28	40.5	0.237

Nickel-Plated Brass Adaptors

0924 Equal Stud Run Tee, Female/Male Metric Thread

	Nickel-plated brass		C1	C2		E	G	H	H1	J	L	kg
			M5x0.8	M5x0.8	0924 00 19	4	8	11	11	9	11	0.009

0917 Equal Stud Run Tee, Male BSPT/Female BSPP Thread

	Nickel-plated brass		C1	C2		E	G	H	H1	J	L	kg
			R1/8	G1/8	0917 00 10	8	13	17	18.5	10	18.5	0.025
			R1/4	G1/4	0917 00 13	11	17	22.5	22.5	12	22.5	0.038
			R3/8	G3/8	0917 00 17	11.5	21	25.5	25.5	15	25.5	0.058
			R1/2	G1/2	0917 00 21	14	26	30	30	19	30	0.090
			R3/4	G3/4	0917 00 27	16.5	32	34.5	35.5	22	35.5	0.177
			R1	G1	0917 00 34	18	38.5	40.5	40.5	28	40.5	0.219

0927 Equal Tee, Male BSPT Thread

	Nickel-plated brass		C		H	J	L	kg
			R1/8	0927 00 10	17	10	34	0.018
			R1/4	0927 00 13	22.5	12	45	0.032
			R3/8	0927 00 17	25.5	15	51	0.056
			R1/2	0927 00 21	30	19	60	0.094
			R3/4	0927 00 27	34.5	22	69	0.133
			R1	0927 00 34	40.5	28	81	0.217

0928 Equal Stud Branch Tee, Male BSPT/Female BSPP Thread


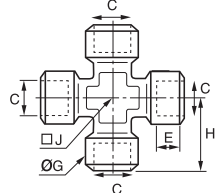

	Nickel-plated brass		C1	C2		E	H	J	L	kg
			R1/8	G1/8	0928 00 10	8	34	10	18.5	0.016
			R1/4	G1/4	0928 00 13	11	45	12	22.5	0.044
			R3/8	G3/8	0928 00 17	11.5	51	15	25.5	0.053
			R1/2	G1/2	0928 00 21	14	60	19	30	0.111
			R3/4	G3/4	0928 00 27	16.5	69	22	35.5	0.236
			R1	G1	0928 00 34	18	81	28	40.5	0.225

0932 Equal Stud Run Tee, Male BSPT/Female BSPP Thread


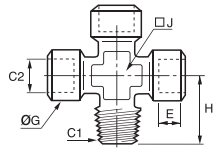

	Nickel-plated brass		C1	C2		E	H	H1	J	L	kg
			R1/8	G1/8	0932 00 10	8	17	18.5	10	17	0.016
			R1/4	G1/4	0932 00 13	11	22.5	22.5	12	22.5	0.035
			R3/8	G3/8	0932 00 17	11.5	25.5	25.5	15	25.5	0.055
			R1/2	G1/2	0932 00 21	14	30	30	19	30	0.091
			R3/4	G3/4	0932 00 27	16.5	34.5	35.5	22	34.5	0.080
			R1	G1	0932 00 34	18	40.5	40.5	28	40.5	0.226

Nickel-Plated Brass Adaptors


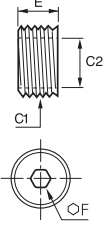

0908 Equal Cross, Female BSPP Thread

	Nickel-plated brass 	C		E	G	H	J	kg
		G1/8	0908 00 10	8	13	21	10	0.038
		G1/4	0908 00 13	11	17	25.5	13	0.073
		G3/8	0908 00 17	11.5	21	28	17	0.107
		G1/2	0908 00 21	14	26	33.5	21	0.189


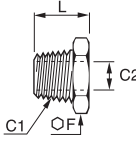

0909 Equal Cross, Male BSPT/Female BSPP Thread

	Nickel-plated brass 	C1	C2		E	G	H	J	kg
		R1/8	G1/8	0909 00 10	8	13	18.5	10	0.034
		R1/4	G1/4	0909 00 13	11	17	23.5	13	0.068
		R3/8	G3/8	0909 00 17	11.5	21	26	17	0.099
		R1/2	G1/2	0909 00 21	14	26	31	21	0.168


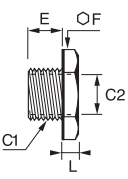

0903 Reducer, Male/Female BSPP Thread

	Nickel-plated brass 	C1	C2		E	F	kg
		G1/4	G1/8	0903 10 13	8	6	0.004
		G3/8	G1/4	0903 13 17	9	8	0.006
		G1/2	G3/8	0903 17 21	10	10	0.010
		G3/4	G1/2	0903 21 27	14	12	0.022
		G1	G3/4	0903 27 34	20	17	0.036

0904 Reducer, Male BSPT/Female BSPP Thread

	Nickel-plated brass 	C1	C2		F	L	kg
		R1/4	G1/8	0904 10 13	14	16	0.010
		R3/8	G1/8	0904 10 17	17	16.5	0.020
			G1/4	0904 13 17	17	16.5	0.015
		R1/2	G1/4	0904 13 21	22	19.5	0.032
			G3/8	0904 17 21	22	19.5	0.025
		R3/4	G3/8	0904 17 27	27	23.5	0.057
			G1/2	0904 21 27	27	23.5	0.044


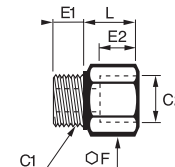

0905 Reducer, Male BSPP/Female BSPP and Metric Thread

	Nickel-plated brass 	C1	C2		E	F	L	kg
		G1/8	M5x0.8	0905 19 10*	6	14	4.5	0.008
		G1/4	G1/8	0905 10 13*	8	17	5	0.011
			G1/8	0905 10 17*	9	19	5	0.019
		G3/8	G1/4	0905 13 17	9	19	5	0.013
			G1/4	0905 13 21	10	24	5.5	0.032
		G1/2	G3/8	0905 17 21	10	24	5.5	0.022
			G3/8	0905 17 27	12	30	5.5	0.053
		G3/4	G1/2	0905 21 27*	12	30	5.5	0.041


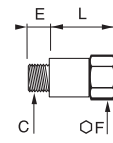

*Please contact us for detailed drawings of threads.

Nickel-Plated Brass Adaptors


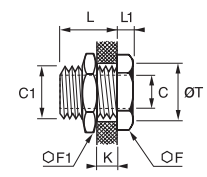

0906 Increaser, Male BSPP and Metric/Female BSPP Thread

		C1	C2		E1	E2	F	L	kg
		M5x0.8	G1/8	0906 10 19	4	8	14	10	0.009
			G1/8	0906 00 10	6	8	14	10	0.011
		G1/8	G1/4	0906 10 13	6	11	17	14	0.016
			G3/8	0906 10 17	6	11.5	22	14.5	0.029
		G1/4	G1/4	0906 00 13	8	11	17	14	0.020
			G3/8	0906 13 17	8	11.5	22	14.5	0.032
			G1/2	0906 13 21	8	15	27	18	0.037
		G3/8	G3/8	0906 00 17	9	11.5	22	14.5	0.034
			G1/2	0906 17 21	9	14	27	18	0.038
		G1/2	G1/2	0906 00 21	10	14	27	18	0.054


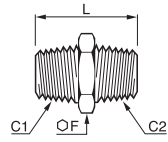

0907 Equal Extended Adaptor, Male/Female BSPP Thread

		C		E	F	L	kg
		G1/8	0907 00 10	6	14	16	0.015
			0907 00 10 01	6	14	36	0.029
		G1/4	0907 00 13	8	17	26	0.032
			0907 00 13 01	8	17	43	0.046

0920 Bulkhead Connector, Female BSPP and Metric Thread


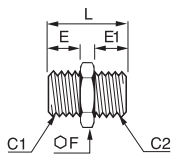

		C	C1		F	F1	K_{max}	L	L1	ØT	kg
		M5x0.8	M10x1	0920 00 19	14	14	7	10.5	3.5	10.5	0.012
		G1/8	M16x1.5	0920 00 10	19	22	9	14	4	16.5	0.029
		G1/4	M20x1.5	0920 00 13	24	27	15	21	4	20.5	0.056
		G3/8	M26x1.5	0920 00 17	30	32	14	21	5	26.5	0.095
		G1/2	M28x1.5	0920 00 21	32	36	20	27	6	28.5	0.115

0900 Equal and Unequal Adaptor, Male BSPT Thread


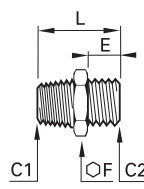

		C1	C2		F	L	kg
		R1/8	R1/8	0900 00 10	12	19.5	0.008
			R1/4	0900 10 13	14	23.5	0.015
			R3/8	0900 10 17	17	24	0.020
		R1/4	R1/4	0900 00 13	14	27	0.017
			R3/8	0900 13 17	17	27.5	0.026
			R1/2	0900 13 21	22	30.5	0.044
		R3/8	R3/8	0900 00 17	17	28	0.026
			R1/2	0900 17 21	22	31	0.046
		R1/2	R1/2	0900 00 21	22	33.5	0.044
			R3/4	0900 21 27	27	37.5	0.084
		R3/4	R3/4	0900 00 27	27	40	0.079
			R1	0900 27 34	34	43	0.144
		R1	R1	0900 00 34	34	45.5	0.153

Nickel-Plated Brass Adaptors


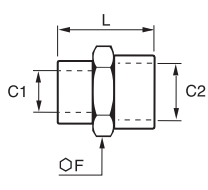

0901 Equal and Unequal Adaptor, Male BSPP and Metric Thread

	Nickel-plated brass 	C1	C2		E	E1	F	L	kg
		M5x0.8	M5x0.8	0901 00 19	4	4	8	11.5	0.002
			G1/8	0901 19 10	4	6	14	14.5	0.008
		G1/8	G1/8	0901 00 10	6	6	14	16.5	0.009
			G1/4	0901 10 13	6	8	17	19	0.016
		G1/4	G1/4	0901 00 13	8	8	17	21	0.019
			G3/8	0901 13 17	8	9	19	22	0.023
		G3/8	G3/8	0901 00 17	9	9	19	23	0.025
			G1/2	0901 17 21	9	10	24	24.5	0.038
		G1/2	G1/2	0901 00 21	10	10	24	25.5	0.041


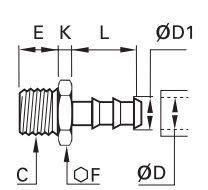

0192 Unequal Straight Adaptor, Male BSPT/BSPP Thread

	Nickel-plated brass 	C1	C2		E	F	L	kg
		R1/8	G1/4	0192 10 13	9.5	17	23.5	0.019
			G1/4	0192 13 13	9.5	17	27.5	0.024
		R1/4	G1/2	0192 13 21	11	27	31.5	0.068
			G1/4	0192 17 13	9.5	17	28	0.025
		G3/8	G1/2	0192 17 21	11	27	31.5	0.061
		R1/2	G1/2	0192 21 21	11	27	34	0.061

0902 Equal and Unequal Adaptor, Female BSPP and Metric Thread

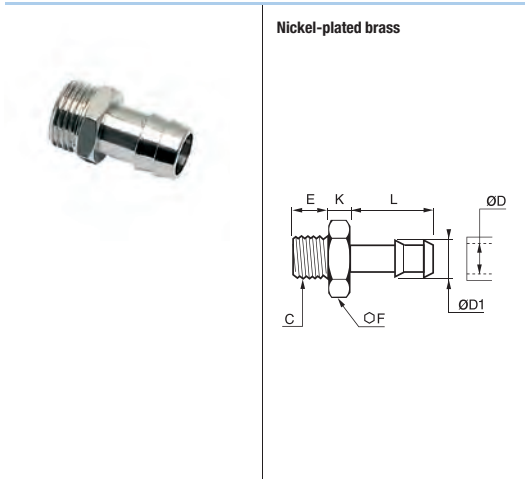
	Nickel-plated brass 	C1	C2		F	L	kg
		M5x0.8	M5x0.8	0902 00 19	8	11	0.003
			G1/8	0902 19 10	14	13	0.009
			G1/8	0902 00 10	14	15	0.010
		G1/8	G1/4	0902 10 13	17	19.5	0.017
			G3/8	0902 10 17	22	20	0.028
			G1/4	0902 00 13	17	22	0.019
		G1/4	G3/8	0902 13 17	22	23	0.031
			G1/2	0902 13 21	27	27	0.033
		G3/8	G3/8	0902 00 17	22	24	0.034
			G1/2	0902 17 21	27	27.5	0.037
		G1/2	G1/2	0902 00 21	27	30	0.050
			G3/4	0902 21 27	30	30	0.077
		G3/4	G3/4	0902 00 27	30	32	0.080


0191 Tailpiece Adaptor for Rubber Hose, Male BSPP Thread

	Nickel-plated brass 	ØD	ØD1	C		E	F	K	L	kg
		4	6	G1/4	0191 04 13	9.5	17	5	22.5	0.019
			9	G1/4	0191 07 13	9.5	17	5	22.5	0.022
		7	9	G1/2	0191 07 21	11	27	7	29.5	0.065
			12.2	G1/4	0191 10 13	9.5	17	5	22.5	0.020
		10	12.2	G1/2	0191 10 21	11	27	7	29.5	0.061
			15.2	G1/4	0191 13 13	9.5	17	5	22.5	0.022
		13	15.2	G1/2	0191 13 21	11	27	7	29.5	0.058
			16	G1/2	0191 16 21	11	27	7	36.5	0.067
		16	18.5	G1/2	0191 16 21	11	27	7	36.5	0.067

Nickel-Plated Brass Adaptors


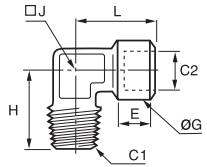

0931 Tailpiece Adaptor for Rubber Hose, Male BSPP Thread




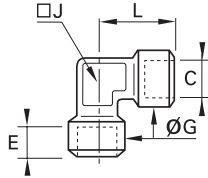

ØD	ØD1	C		E	F	K	L	kg
6	7	G1/8	0931 06 10	6	12	4	20	0.009
	7	G1/4	0931 06 13	8	14	5	20	0.013
7	8	G1/8	0931 07 10	6	12	4	20	0.009
	8	G1/4	0931 07 13	8	14	5	20	0.013
8	8	G3/8	0931 07 17	9	19	5	20	0.022
	9	G1/8	0931 08 10	6	12	4	20	0.009
8	9	G1/4	0931 08 13	8	14	5	20	0.014
	9	G3/8	0931 08 17	9	19	5	20	0.022
10	12	G1/4	0931 10 13	8	14	5	20	0.016
	12	G3/8	0931 10 17	9	19	5	20	0.024
15	12	G1/2	0931 10 21	10	22	6	22	0.031
	17	G3/8	0931 15 17	9	19	6	24	0.030
18	17	G1/2	0931 15 21	10	22	6	24	0.037
	20	G1/2	0931 18 21	10	22	6	24	0.039

Stainless Steel Adaptors


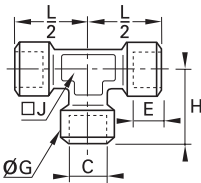

1844 Equal Stud Elbow, Male BSPT/Female BSPP Thread

	Stainless steel 316L 	C1	C2		E	G	H	J	L	kg
		R1/8	G1/8	1844 10 10	7.5	15	20.5	10	22.5	0.022
		R1/4	G1/4	1844 13 13	12	18.5	27.5	12	26.5	0.044
		R3/8	G3/8	1844 17 17	12	23.5	28	14	30	0.067
		R1/2	G1/2	1844 21 21	15	28	38	18	38	0.114
		R3/4	G3/4	1844 27 27	16.5	33	41	22	44.5	0.154
		R1	G1	1844 34 34	19	40	48	32	50	0.312


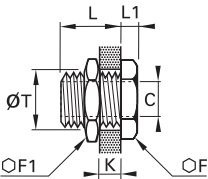

1843 Equal Elbow, Female BSPP Thread

	Stainless steel 316L 	C		E	G	J	L	kg
		G1/8	1843 10 10	7.5	17.5	12	22.5	0.041
		G1/4	1843 13 13	11	18.5	15	26.5	0.055
		G3/8	1843 17 17	11.5	23.5	18	29	0.076
		G1/2	1843 21 21	15	28	23	38	0.159
		G3/4	1843 27 27	16.5	33	22	43.5	0.232
		G1	1843 34 34	19	40	32	52	0.444


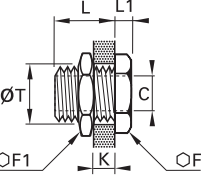

1845 Equal Tee, Female BSPP Thread

	Stainless steel 316L 	C		E	G	H	J	L/2	kg
		G1/8	1845 10 10	7.5	17.5	22.5	12	22.5	0.060
		G1/4	1845 13 13	11	18.5	26.5	15	26.5	0.078
		G3/8	1845 17 17	11.5	23.5	29	18	29	0.100
		G1/2	1845 21 21	15	28	38	23	38	0.221
		G3/4	1845 27 27	16.5	33	43.5	22	43.5	0.301
		G1	1845 34 34	19	40	50	32	50	0.457

1817 Equal Bulkhead Adaptor, Female BSPP Thread

	Stainless steel 316L 	C		F	F1	K_{max}	L	L1	ØT_{min}	kg
		G1/8	1817 00 10	19	22	9	14	4	16.5	0.030
		G1/4	1817 00 13	24	27	15	21	4	20.5	0.053
		G3/8	1817 00 17	30	32	14	21	5	26.5	0.091
		G1/2	1817 00 21	32	36	20	27	6	28.5	0.109
		G3/4	1817 00 27	41	41	22.5	30	6	34.5	0.152
		G1	1817 00 34	46	50	24.5	34	8	42.5	0.252

1871 Equal Bulkhead Adaptor, Female NPT Thread

	Stainless steel 316L 	C		F	F1	K_{max}	L	L1	ØT_{min}	kg
		NPT1/8	1871 00 11	19	22	9	14	5	16.5	0.032
		NPT1/4	1871 00 14	24	22	9	14	5	16.5	0.060
		NPT3/8	1871 00 18	30	32	18	23	5	26.5	0.096
		NPT1/2	1871 00 22	32	36	22	29	6	28.5	0.120

Stainless Steel Adaptors

1855 Equal Connector, Female BSPP Thread

	Stainless steel 316L		C		F	L	kg
			G1/8	1855 10 10	14	17	0.013
			G1/4	1855 13 13	17	24	0.024
			G3/8	1855 17 17	22	25	0.042
			G1/2	1855 21 21	27	32	0.078
			G3/4	1855 27 27	14	35	0.102
			G1	1855 34 34	41	40	0.202

1870 Equal Connector, Female NPT Thread

	Stainless steel 316L		C		F	L	kg
			NPT1/8	1870 11 11	14	19	0.015
			NPT1/4	1870 14 14	17	28	0.029
			NPT3/8	1870 18 18	22	28	0.050
			NPT1/2	1870 22 22	27	35	0.093

1862 Reducer Connector, Female BSPP Thread

	Stainless steel 316L		C1	C2		F	L	kg
			G1/4	G1/8	1862 13 10	17	20.5	0.024
			G3/8	G1/8	1862 17 10	22	21	0.043
				G1/4	1862 17 13	22	24.5	0.049
			G1/2	G1/4	1862 21 13	27	28.5	0.086
				G3/8	1862 21 17	27	29	0.080
			G3/4	G1/2	1862 27 21	32	39.5	0.144
			G1	G3/4	1862 34 27	41	45	0.280

1864 Adaptor, Male NPT/Female BSPP Thread


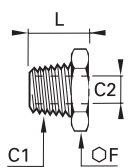
	Stainless steel 316L		C1	C2		E	F	L	kg
			NPT1/8	G1/8	1864 11 10	7.5	14	21.5	0.015
			NPT1/4	G1/4	1864 14 13	11	17	30	0.028
			NPT3/8	G3/8	1864 18 17	11.5	22	31	0.043
			NPT1/2	G1/2	1864 22 21	15	27	39.5	0.080

1867 Adaptor, Male BSPT/Female NPT Thread


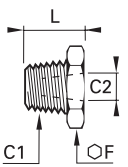
	Stainless steel 316L		C1	C2		E	F	L	kg
			R1/8	NPT1/8	1867 10 11	8	14	21	0.015
			R1/4	NPT1/4	1867 13 14	11.5	17	28.5	0.028
			R3/8	NPT3/8	1867 17 18	12	22	29.5	0.044
			R1/2	NPT1/2	1867 21 22	15.5	27	37.5	0.083

Stainless Steel Adaptors


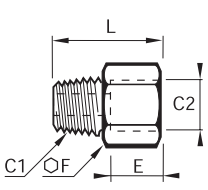
1863 Reducer, Male BSPT/Female BSPP Thread

Image	Stainless steel 316L	Diagram	C1	C2	Icon	F	L	kg
	Stainless steel 316L		R1/4	G1/8	1863 13 10	14	16	0.008
			R3/8	G1/8	1863 17 10	17	16.5	0.019
				G1/4	1863 17 13	17	16.5	0.011
			R1/2	G1/4	1863 21 13	22	21	0.036
				G3/8	1863 21 17	22	21	0.023
			R3/4	G1/2	1863 27 21	27	25.5	0.045
R1	G3/4	1863 34 27	36	28.5	0.083			


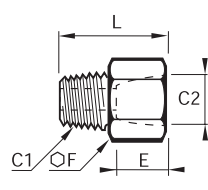
1872 Reducer, Male/Female NPT Thread

Image	Stainless steel 316L	Diagram	C1	C2	Icon	F	L	kg
	Stainless steel 316L		NPT1/4	NPT1/8	1872 14 11	14	16	0.010
			NPT3/8	NPT1/8	1872 18 11	19	16.5	0.023
				NPT1/4	1872 18 14	19	16.5	0.016
			NPT1/2	NPT1/4	1872 22 14	22	21	0.039
				NPT3/8	1872 22 18	22	21	0.028


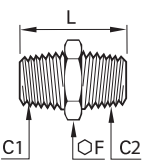
1861 Increaser, Male BSPT/Female BSPP Thread

Image	Stainless steel 316L	Diagram	C1	C2	Icon	E	F	L	kg
	Stainless steel 316L		R1/8	G1/4	1861 10 13	11	17	24	0.022
				G3/8	1861 10 17	11.5	22	25	0.038
			R1/4	G3/8	1861 13 17	11.5	22	28.5	0.042
				G1/2	1861 13 21	15	27	32.5	0.068
			R3/8	G1/2	1861 17 21	15	27	33	0.070
			R1/2	G3/4	1861 21 27	16.5	32	38	0.093
			R3/4	G1	1861 27 34	19	41	43.5	0.182

1873 Increaser, Male/Female NPT Thread


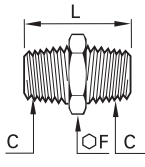

Image	Stainless steel 316L	Diagram	C1	C2	Icon	E	F	L	kg
	Stainless steel 316L		NPT1/8	NPT1/4	1873 11 14	14	17	25	0.024
				NPT3/8	1873 11 18	14	22	25	0.039
			NPT1/4	NPT3/8	1873 14 18	14	22	28.5	0.042
				NPT1/2	1873 14 22	17.5	27	31	0.065
			NPT3/8	NPT1/2	1873 18 22	17.5	27	31.5	0.066

1821 Equal and Unequal Adaptor, Male BSPT Thread


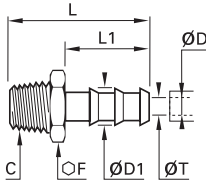

Image	Stainless steel 316L	Diagram	C1	C2	Icon	F	L	kg
	Stainless steel 316L		R1/8	R1/8	1821 10 10	12	19	0.009
				R1/8	1821 13 10	14	23.5	0.016
			R1/4	R1/4	1821 13 13	14	27	0.019
				R1/4	1821 17 13	17	27.5	0.024
			R3/8	R3/8	1821 17 17	17	28	0.024
				R3/8	1821 21 17	22	32.5	0.042
			R1/2	R1/2	1821 21 21	22	36	0.048
				R1/2	1821 27 21	27	41	0.079
			R3/4	R3/4	1821 27 27	27	42	0.088
				R3/4	1821 34 27	36	46	0.141
			R1	R1	1821 34 34	36	48	0.146

Stainless Steel Adaptors


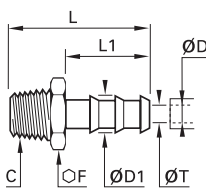

1821 Equal Adaptor, Male NPT Thread

	Stainless steel 316L 	C		F	L	kg
		NPT1/8	1821 11 11	12	23	0.011
NPT1/4	1821 14 14	14	32	0.023		
NPT3/8	1821 18 18	19	33	0.031		
NPT1/2	1821 22 22	22	42	0.057		
NPT3/4	1821 28 28	27	40	0.082		
NPT1	1821 35 35	36	46	0.138		

1823 Tailpipe Adaptor for Rubber Hose, Male BSPT Thread

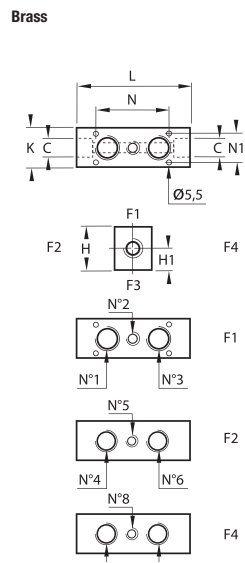
	Stainless steel 316L 	ØD	ØD1	C		F	L	L1	ØT	kg
		7	9	R1/8	1823 07 10	10	34	22.5	5	0.009
		9	R1/4	1823 07 13	14	38.5	22.5	6	0.016	
		10	12.2	R1/4	1823 10 13	14	38.5	22.5	7	0.018
			12.2	R3/8	1823 10 17	17	39	22.5	9.5	0.021
		13	15	R3/8	1823 13 17	17	46	29.5	11	0.025
		16	18.5	R1/2	1823 16 21	22	59	38	14	0.050

1823 Tailpipe Adaptor for Rubber Hose, Male NPT Thread

	Stainless steel 316L 	ØD	ØD1	C		F	L	L1	ØT	kg
		1/4	8.3	NPT1/8	1823 56 11	12	34	22.5	5.3	0.010
	8.3	NPT1/4	1823 56 14	14	38.5	22.5	5.3	0.016		
	11.7	NPT1/4	1823 60 14	14	38.5	22.5	8.5	0.018		
	11.7	NPT3/8	1823 60 18	19	39	22.5	8.5	0.026		

Brass Manifolds

0135 Manifold Block, Female BSPP Thread



C		H	H1	K	L	N	N1	kg
G1/4	0135 06 13	30	13	25	70	37	17	0.329
	0135 09 13	30	13	25	87	54	17	0.409
G1/2	0135 06 21	40	16	35	86	45	27	0.714
	0135 09 21	40	16	35	109	68	27	0.899
G3/4	0135 10 27	45	21	40	122	78	32	1.232


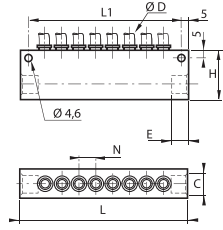
This product is designed to distribute in several directions.
The number of ports can be increased by using tee pieces, cross pieces or double banjo couplings.

Installation Options


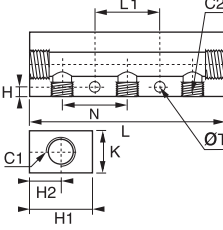
	F1			F2				F4				
	Number of Outlets	N°1	N°2	N°3	Number of Outlets	N°4	N°5	N°6	Number of Outlets	N°7	N°8	N°9
0135 06 13	1		G1/4		2	G1/8		G1/8	2	G1/8		G1/8
0135 09 13	2	G1/4		G1/4	3	G1/8	G1/8	G1/8	3	G1/8	G1/8	G1/8
0135 06 21	1		G1/2		2	G1/4		G1/4	2	G1/8		G1/8
0135 09 21	2	G1/2		G1/2	3	G1/4	G1/4	G1/4	3	G1/8	G1/8	G1/8
0135 10 27	3	G1/2	G1/8	G1/2	3	G1/8	G1/8	G1/8	3	G1/4	G1/8	G1/4

Anodised Aluminium Manifolds


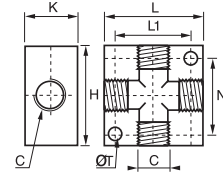
3310 In-Line Manifold

	Treated aluminium, NBR			ØD	C		Number of Outlets	E	H	L	L1	N	kg
	4	G1/4		3310 04 13	8	10	33	114	104	11.5	0.175		
	6	G1/4		3310 06 13	8	10	33	114	104	12.5	0.169		
	8	G3/8		3310 08 17	6	12	33	114	104	15	0.156		
	10	G1/2		3310 10 21	6	14	48	130	119.5	17	0.348		
	12	G1/2		3310 12 21	6	14	45	117	107	20.5	0.370		


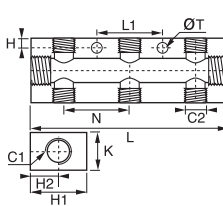
3311 Manifold, Female BSPP and Metric Thread

	Treated aluminium			C1	C2		Number of Outlets	H	H1	H2	K	L	L1	N	ØT	kg
	G1/8	M5x0.8		3311 19 10 07	7	3.5	20	8.5	15	95	80	11	4.4	0.067		
	G1/8			3311 10 13 02	2	4.5	30	15	20	61	50	30	5	0.079		
	G1/8			3311 10 13 03	3	4.5	30	15	20	91	30	30	5	0.121		
	G1/4	G1/8		3311 10 13 04	4	4.5	30	15	20	121	60	30	5	0.165		
	G1/8			3311 10 13 05	5	4.5	30	15	20	151	90	30	5	0.209		
	G1/8			3311 10 13 06	6	4.5	30	15	20	181	120	30	5	0.244		
	G1/4			3311 13 17 02	2	5.5	30	11	20	74	61	36	6.5	0.076		
	G1/4			3311 13 17 03	3	6	30	11	20	110	36	36	6.5	0.121		
	G3/8	G1/4		3311 13 17 04	4	6	30	11	20	146	72	36	6.5	0.144		
	G1/4			3311 13 17 05	5	6	30	11	20	182	108	36	6.5	0.212		
	G1/4			3311 13 17 06	6	6	30	11	20	218	144	36	6.5	0.265		

3312 Cross Manifold, Female BSPP and Metric Thread


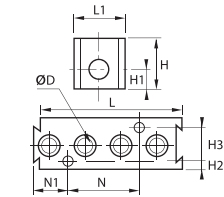

	Treated aluminium			C		H	K	L	L1	N	ØT	kg
	M5x0.8	3312 00 19		20	10	20	12	12	4.5	0.010		
	G1/8	3312 00 10		30	16	30	23	22	4.5	0.029		
	G1/4	3312 00 13		40	20	40	30	27	5.5	0.066		
	G3/8	3312 00 17		50	25	50	38	39	6.5	0.126		
	G1/2	3312 00 21		50	25	50	38	39	6.5	0.101		

3313 Double Manifold, Female BSPP Thread


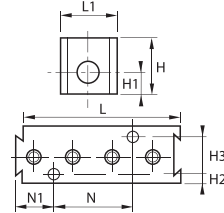

	Treated aluminium			C1	C2		Number of Outlets	H	H1	H2	K	L	L1	N	ØT	kg
	G1/8			3313 10 13 02	2x2	4.5	30	15	20	61	50	30	5	0.075		
	G1/8			3313 10 13 03	2x3	4.5	30	15	20	91	30	30	5	0.115		
	G1/8			3313 10 13 04	2x4	4.5	30	15	20	121	60	30	5	0.151		
	G1/8			3313 10 13 05	2x5	4.5	30	15	20	151	90	30	5	0.194		
	G1/4			3313 13 17 02	2x2	6	40	20	20	74	61	36	6.5	0.109		
	G1/4			3313 13 17 03	2x3	6	40	20	20	110	36	36	6.5	0.179		
	G1/4			3313 13 17 04	2x4	6	40	20	20	146	72	36	6.5	0.238		
	G1/4			3313 13 17 05	2x5	6	40	20	20	182	108	36	6.5	0.286		
	G1/4			3313 13 21 03	2x3	6	40	20	28	116	36	36	6.5	0.222		
	G1/2	G1/4		3313 13 21 04	2x4	6	40	20	28	152	72	36	6.5	0.295		
	G1/2	G1/4		3313 13 21 05	2x5	6	40	20	28	188	108	36	6.5	0.369		

Anodised Aluminium Manifolds


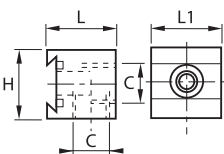

3301 Modular Manifold

	Treated aluminium, NBR 	$\varnothing D$ 	Number of Outlets	H	H1	H2	H3	L	L1	N	N1	kg	
		4	3301 04 00	8	25	10	4.5	16	73.5	25	35	17	0.105
		6	3301 06 00	4	25	10	4.5	16	73.5	25	35	17	0.108
Fixing with screw M3x20													


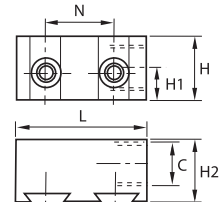

3301 Manifold, Female BSPP Thread

	Treated aluminium, NBR 	C 	Number of Outlets	H	H1	H2	H3	L	L1	N	N1	kg	
		G1/8	3301 07 10	4	25	10	4.5	16	73.5	25	35	17	0.097
		Fixing with screw M3x20 NPT available on request											


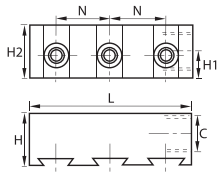

3302 Single Manifold, Female BSPP Thread

	Treated aluminium, NBR 	C 	H	L	L1	kg	
		G1/4	3302 01 13	25	24.5	25	0.030
			3302 01 13 01	25	24.5	25	0.031
3302 01 13: side entry thread 3302 01 13 01: rear entry thread NPT available on request							

3302 Double Manifold, Female BSPP Thread


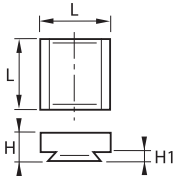

	Treated aluminium, NBR 	C 	H	H1	H2	L	N	kg	
		G3/8	3302 02 17	25	12.5	24.5	51	26	0.061
		Side entry thread NPT available on request							

3302 Triple Manifold, Female BSPP Thread


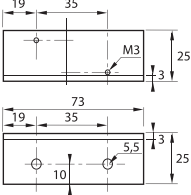

	Treated aluminium, NBR 	C 	H	H1	H2	L	N	kg	
		G3/8	3302 03 17	25	12.5	25	77	26	0.087
		Side entry thread NPT available on request							

Anodised Aluminium Manifolds

3303 End Plate for Manifold

	Treated aluminium 		H	H1	L	kg
			3303 00 01	9.5	3.5	25

3303 Angled Fixing Plate

	Treated aluminium 		kg
			3303 00 02

Brass Plugs

0205 Internal Hexagon Head Plug, Male BSPT Thread

	Brass		C		E1	E2 min	E2 max	F	G	H	kg
			R1/8	0205 10 00	6	3.1	4.9	5	9.7	8	0.003
			R1/4	0205 13 00	8	4.7	7.3	6	13.2	10	0.007
			R3/8	0205 17 00	8	5.1	7.7	8	16.7	11	0.013
			R1/2	0205 21 00	8	6.4	10	10	21	13	0.026
			R3/4	0205 27 00	11	7.7	11.3	14	26.4	17	0.054
			R1	0205 34 00	13	8.1	12.7	17	33.2	19	0.094
			R1¼	0205 42 00	14	10.4	15	22	41.9	22	0.176
			R1½	0205 49 00	14	10.4	15	24	47.8	22	0.246
			R2	0205 48 00	16	13.6	18.2	30	59.6	25	0.431
			For BSPT plug from 1/2" - 1½" inclusive: Conforms to DIN 906 Thread: EN 10226-1								

0205 Internal Hexagon Head Plug, Male NPT Thread

	Brass		C		E1	E2 min	E2 max	F	G	H	kg
			NPT1/8	0205 11 00	6	3.2	5	5	10.2	8	0.003
			NPT1/4	0205 14 00	8	4.4	7.2	6	13.6	10	0.008
			NPT3/8	0205 18 00	8	4.7	7.5	8	17	11	0.014
			NPT1/2	0205 22 00	8	6.3	9.9	10	21.2	13	0.026
			NPT3/4	0205 28 00	11	6.8	10.4	14	26.6	17	0.052
			NPT1	0205 35 00	13	8	12.4	17	33.2	19	0.091

0209 Square Head Plug, Male BSPT Thread

	Brass		C		E1	E2 min	E2 max	G	H	J	kg
			R1/8	0209 10 00	6	3.1	4.9	9.7	16	6	0.007
			R1/4	0209 13 00	8	4.7	7.3	13.2	18	8	0.014
			R3/8	0209 17 00	10	5.1	7.7	16.7	20	10	0.025
			R1/2	0209 21 00	11	6.4	10	21	22	13	0.047
			R3/4	0209 27 00	15	7.7	11.3	26.4	28	17	0.097
			R1	0209 34 00	18	8.1	12.7	33.2	32	19	0.170
			Conforms to DIN 906 Thread: EN 10226-1								

0220 Hex Head Plug, Male BSPP and Metric Thread


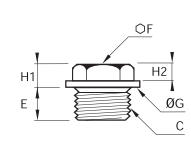

	Brass, technical polymer		C		F	G	H1	kg
			M5x0.8	0220 19 00	8	8	5	0.002
			G1/8	0220 10 00	14	14	7.5	0.011
			G1/4	0220 13 00	17	17	7.5	0.019
			G3/8	0220 17 00	17	22	8.5	0.024
			G1/2	0220 21 00	22	27	10	0.040
			Pre-assembled polyamide washer M5: with screwdriver slot for tightening Maximum allowable working pressure = 20 bar Part number with suffix 99, maximum allowable working pressure = 250 bar, example: 0220 19 00 99 Conforms to BNA 229 (with the exception of M5 model), BSPP thread, ISO ISO 228-1, Parallel, metric thread, ISO NFE 03-054					

0200 Hex Head Plug, Male BSPP and Metric Thread


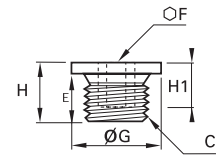

	Brass		C		E	F	G	H1	H2	kg
			M6x1	0200 52 00	6	10	10	4	3.5	0.004
			M8x1.25	0200 57 00	7	13	13	4	3.5	0.007
			M10x1	0200 60 00	8	14	14	5	4.5	0.011
			M12x1	0200 65 00	9	17	17	5	4.5	0.018
			M12x1.25	0200 66 00	9	17	17	5	4.5	0.017
			G1/8	0200 10 00	7	14	13.7	5.5	4	0.011
			G1/4	0200 13 00	8.5	17	16.7	5.5	4	0.019

Brass Plugs

0201 Hex Head Plug with Collar, Male BSPP and Metric Thread

	Brass 	C		E	F	G	H1	H2	kg
		M16x1.5	0201 75 00	10	17	22	6.5	5	0.025
M18x1.5	0201 78 00	10	17	24	7	5	0.026		
M20x1.5	0201 80 00	10	17	26	7.5	5	0.031		
M22x1.5	0201 82 00	10	22	30	7.5	5	0.044		
M24x1.5	0201 83 00	10	22	32	7.5	5	0.046		
M24x2	0201 92 00	10	22	32	7.5	5	0.046		
M30x2	0201 88 00	11	27	38	8.5	6	0.075		
G3/8	0201 17 00	10	17	21.7	6.5	4.5	0.024		
G1/2	0201 21 00	10	22	26.7	7.5	5	0.041		
G3/4	0201 27 00	11	22	31.7	8.5	6	0.057		
G1	0201 34 00	11	27	39.7	8.5	6	0.087		
G1¼	0201 42 00	12	30	49.7	10	7	0.142		



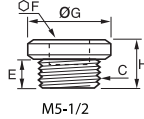
0202 Internal Hexagon Head Plug with Collar, Male Metric Thread

	Brass 	C		E	F	G	H	H1	kg
		M12x1	0202 65 00	9	6	17	11	8	0.009
M12x1.25	0202 66 00	9	6	17	11	8	0.009		
M14x1.5	0202 71 00	10	6	19	13	10	0.015		
M16x1.5	0202 75 00	10	8	22	13	10	0.020		
M18x1.5	0202 78 00	10	10	24	13	10	0.022		
M20x1.5	0202 80 00	10	12	26	13	10	0.025		
M22x1.5	0202 82 00	10	12	30	13	10	0.034		
M27x2	0202 86 00	11	17	35	15	11	0.053		
M30x2	0202 88 00	11	19	38	15	11	0.062		

Parallel metric threads, ISO standard NFE 03-054


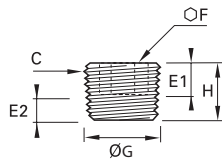

Nickel-Plated Brass Plugs

0919 Internal Hexagon Head Plug, Male BSPP and Metric Thread


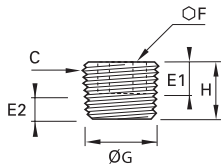

	Nickel-plated brass	C		E	F	G	H	kg
	 M5-1/2	M5x0.8	0919 00 19	4	2.5	8	7.5	0.001
		G1/8	0919 00 10	6	3	15	10	0.007
		G1/4	0919 00 13	8	6	18	12	0.013
		G3/8	0919 00 17	9	8	21	13	0.021
		G1/2	0919 00 21	10	10	25	14.5	0.036
		G3/4	0919 00 27	11	30	-	17	0.050
		G1	0919 00 34	13	38	-	19	0.076

Steel Plugs


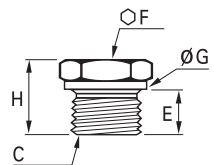

0206 Internal Hexagon Head Plug, Male BSPT Thread

		C		E1	E2 min	E2 max	F	G	H	kg
		R1/8	0206 10 00	6	3.1	4.9	5	9.7	8	0.003
		R1/4	0206 13 00	8	4.7	7.3	6	13.2	10	0.007
		R3/8	0206 17 00	8	5.1	7.7	8	16.7	11	0.012
		R1/2	0206 21 00	8	6.4	10	10	21	13	0.023
		R3/4	0206 27 00	11	7.7	11.3	14	26.4	17	0.048
		R1	0206 34 00	13	8.1	12.7	17	33.2	19	0.086
		R1¼	0206 42 00	14	10.4	15	22	41.9	22	0.166
		R1½	0206 49 00	14	10.4	15	24	47.8	22	0.222
		For BSPT plugs, from 1/2" - 1½" inclusive Conforms to DIN 906 Thread, conforms to EN 10226-1								


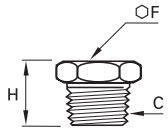

0206 Internal Hexagon Head Plug, Male NPT Thread

		C		E1	E2 min	E2 max	F	G	H	kg
		NPT1/16	0206 08 00	6	3.8	6.4	4	7.8	7	0.002
		NPT1/8	0206 11 00	6	3.2	5	5	10.2	8	0.003
		NPT1/4	0206 14 00	8	4.4	7.2	6	13.6	10	0.007
		NPT3/8	0206 18 00	8	4.7	7.5	8	17	11	0.012
		NPT1/2	0206 22 00	8	6.3	9.9	10	21.2	13	0.024
		NPT3/4	0206 28 00	11	6.8	10.4	14	26.6	17	0.047
		NPT1	0206 35 00	13	8	12.4	17	33.2	19	0.083


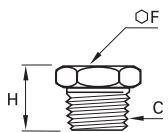

0210 Hex Head Plug, Male BSPP and Metric Thread

		C		E	F	G	H	kg		
		M8x1.25	0210 57 00	8	14	12	15	0.010		
		M10x1	0210 60 00	8	14	14	15	0.013		
		M12x1.25	0210 66 00	11	17	17	18	0.021		
		G1/8	0210 10 00	8	14	14	15	0.012		
		M14x1.25	0210 70 00	11	19	19	20	0.032		
		G1/4	0210 13 00	12	19	18	21	0.031		
		G3/8	0210 17 00	12	22	22	21	0.046		
		G1/2	0210 21 00	14	27	26	24	0.078		
		G3/4	0210 27 00	16	32	32	27	0.134		
		G1	0210 34 00	18	41	39	33	0.269		
		G1¼	0210 42 00	20	50	49	35	0.441		
		Profile of head undercut conforms to DIN 3852-1; form D/E BSPP threads, ISO 228-1 Parallel metric threads, NFE 03-054								

0216 Hex Head Plug, Male BSPT Thread


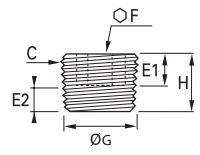

		C		F	H	kg
		R1/8	0216 10 00	13	16	0.012
		R1/4	0216 13 00	17	19	0.023
		R3/8	0216 17 00	19	21	0.038
		R1/2	0216 21 00	22	23	0.060
BSPT thread conforms to EN 10226-1						

0216 Hex Head Plug, Male NPT Thread


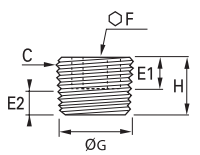

		C		F	H	kg
		NPT1/8	0216 11 00	13	16	0.012
		NPT1/4	0216 14 00	17	19	0.024
		NPT3/8	0216 18 00	19	21	0.038
		NPT1/2	0216 22 00	22	23	0.060

Stainless Steel Plugs

0285 Internal Hexagon Head Plug, Male BSPT Thread



	Stainless steel 316L 	C		E1	E2 min	E2 max	F	G	H	kg
		R1/8	0285 10 00	6	3.1	4.9	5	9.7	8	0.003
		R1/4	0285 13 00	8	4.7	7.3	6	13.2	10	0.007
		R3/8	0285 17 00	8	5.1	7.7	8	16.7	11	0.013
		R1/2	0285 21 00	8	6.4	10	10	21	13	0.024
		R3/4	0285 27 00	11	7.7	11.3	14	26.4	17	0.051
		R1	0285 34 00	13	8.1	12.7	17	33.2	19	0.089

0285 Internal Hexagon Head Plug, Male NPT Thread

	Stainless steel 316L 	C		E1	E2 min	E2 max	F	G	H	kg
		NPT1/8	0285 11 00	6	3.2	5	5	10.2	8	0.003
		NPT1/4	0285 14 00	8	4.4	7.2	6	13.6	10	0.007
		NPT3/8	0285 18 00	8	4.7	7.5	8	17	11	0.013
		NPT1/2	0285 22 00	8	6.3	9.9	10	21.2	13	0.025



Sealing Accessories

0138 Copper Washer

Copper	C		G1	G2	K	kg
	M6	0138 06 00	6.3	9	1	0.033
	M8	0138 08 00	8.3	11	1	0.001
	M12	0138 12 00	12.3	15.5	1.3	0.072
	M14	0138 14 00	14.3	18	1.5	0.001
	M16	0138 16 00	16.3	20	1.5	0.001
	M18	0138 18 00	18.3	22	1.5	0.001
	M20	0138 20 00	20.3	24	1.5	0.001
	M22	0138 22 00	22.3	27	1.5	0.002
	M24	0138 24 00	24.3	29	2	0.003
	M26	0138 26 00	26.3	31	2	0.003
	M30	0138 30 00	30.3	36	2	0.004
	M36	0138 36 00	36.3	42	2	0.005
	M39	0138 39 00	39.3	44	2	0.007
	M45	0138 45 00	45.3	52	2	0.007
	M52	0138 52 00	52.3	60	2	0.009
	G1/8	0138 10 00	10.3	13.5	1	0.001
	G1/4	0138 13 00	13.5	18	1.3	0.001
	G3/8	0138 17 00	17.3	21	1.5	0.001
	G1/2	0138 21 00	21.3	26	1.5	0.002
	G3/4	0138 27 00	27.3	32	2	0.003
	G1	0138 33 00	33.5	39	2	0.005
	G1 1/4	0138 42 00	42.5	49	2	0.007
	G1 1/2	0138 48 00	48.3	55	2	0.008
	G2	0138 60 00	60	68	2.5	0.014

DIN 7603
ISO 65061



0137 Bonded Seal

Zinc-plated steel with NBR seal	C		G1	G2	K	kg
	M12	0137 12 00	12.7	19	1.5	0.001
	M14	0137 14 00	14.7	21	1.5	0.001
	M16	0137 16 00	16.7	23	1.5	0.002
	M18	0137 18 00	18.7	27	2	0.004
	M20	0137 20 00	20.7	29	2	0.004
	M22	0137 22 00	22.7	31	2	0.005
	M24	0137 24 00	24.7	33	2	0.005
	M30	0137 30 00	30.7	39	2	0.071
	M39	0137 39 00	40	51	2.5	0.012
	M45	0137 45 00	46	57	2.5	0.014
	G1/8	0137 10 00	10.7	17	1.5	0.001
	G1/4	0137 13 00	13.7	20.6	2.1	0.002
	G3/8	0137 17 00	17.4	23.7	1.5	0.002
	G1/2	0137 21 00	21.5	28.6	2.5	0.004
	G3/4	0137 27 00	27	35.3	2	0.007
	G1	0137 33 00	33.7	42	2	0.007
	G1 1/4	0137 42 00	43	54	2.5	0.013
	G1 1/2	0137 48 00	49	60	2.5	0.015
	G2	0137 60 00	60.7	73	3	0.027



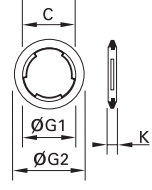
Note: to use these bonded seals successfully it is necessary to spot face around the female thread to provide a sealing face.
The diameter should be 0.3 mm to 0.5 mm greater than the external diameter of the seal.
The surface finish of the spot face should not exceed 12 µ.

Sealing Accessories



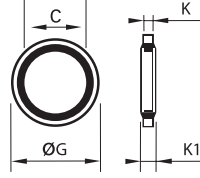
0605 Fluoropolymer Tape

	FKM		kg
		0605 12 12	0.012
<p>Can be used for temperatures from - 250°C to +260°C. Chemically inert and resistant to gases, acids, solvents, hydrocarbons, oils, alkalines, steam etc. Non-toxic, waterproof, self-lubricating. In accordance with CFR21. Can be used on all materials. Used to facilitate the preparation of leak-free threaded joints. Supplied on a reel, length = 12 m; width = 12.7 mm; thickness 0.08 mm.</p>			

0602 Captive Sealing Washer

	Technical polymer	C		G1	G2	K	kg
			M5x0.8	0602 29 93 15	5.2	7.8	1.5
		G1/8	0602 23 10 20	10.3	14	2	0.001
		G1/4	0602 23 11 20	13.7	17.5	2	0.001
		G3/8	0602 23 12 20	17.2	21	2	0.001
		G1/2	0602 23 13 20	21.5	25.5	2.5	0.002
		G3/4	0602 27 32 20	27	32	2.5	0.001
		G1	0602 30 60 20	33.8	39	3	0.001
<p>Maximum allowable working pressure: 20 bar</p>							

0139 Bi-Material Captive Sealing Washer

	Zinc-plated steel with NBR seal	C		G	K	K1	kg
			G1/8	0139 10 00	14	1	1.7
		G1/4	0139 13 00	17	1	1.7	0.001
		G3/8	0139 17 00	22	1.2	2.1	0.001
		G1/2	0139 21 00	26	1.6	2.5	0.002
		G3/4	0139 27 00	32	1.5	2.5	0.003
		G1	0139 34 00	39.6	1.7	2.6	0.003
<p>Maximum allowable working pressure: 250 bar</p>							

Technical characteristics of captive seals **0602**


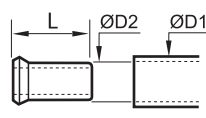

Tightening torque



	M5x0.8	G1/8	G1/4	G3/8	G1/2	G3/4	G1
Min. Torque in daN.m	0.06	0.08	0.3	0.5	1	1.2	1.9
Max. Torque daN.m	0.16	0.8	1.2	3	3.5	6	9


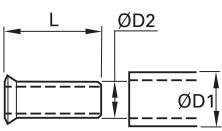

Tube Supports

0127 Brass Tube Support for Polymer Tubing

	Brass 	ØD1	ØD2		L	kg
		4	2	0127 04 00	11	0.001
			2.7	0127 04 27	11	0.001
		5	3	0127 05 03	11	0.001
			3.3	0127 05 00	11.5	0.009
		6	4	0127 06 00	11.5	0.001
		8	5.5	0127 08 55	14	0.001
			6	0127 08 00	14	0.001
			7	0127 10 07	18	0.001
		10	7.5	0127 10 75	18	0.001
			8	0127 10 00	18	0.002
			8	0127 12 08	18	0.002
		12	9	0127 12 09	18	0.002
			10	0127 12 00	18	0.001
			11	0127 14 11	18	0.002
		14	12	0127 14 00	18	0.002
		15	12	0127 15 12	18	0.002
		16	13	0127 16 13	18	0.003
		18	14	0127 18 14	19.5	0.003
20	15	0127 20 15	20.5	0.003		
22	16	0127 22 16	21	0.004		
25	19	0127 25 19	25	0.007		

This tube support guarantees good gripping, at high temperatures and pressures, by preventing collapsing of the tube.

1827 Stainless Steel Tube Support for Fluoropolymer Tubing

	Stainless steel 316L 	ØD1	ØD2		L	kg
		6	4	1827 06 00	11.5	0.001
		8	6	1827 08 00	14	0.001
		10	8	1827 10 00	18	0.001
		12	9	1827 12 09	18	0.001
			10	1827 12 00	18	0.001
16	14	1827 16 00	18	0.002		

This tube support is necessary when using fluoropolymer FEP tubing at all temperatures compatible with the fitting/tubing assembly.



Together, we can connect you to the best in technology

Inventor of the push-in fitting with more than 40 years of experience, Parker Legris has the know-how necessary for providing fluid connectors adapted to a wide variety of environments, such as production automation, packaging, transport, food process and the medical industry. Our wide selection of fittings, tubing, ball valves and accessories, along with our capacity to develop specific products, allow our customers to find the very best connector solution. Parker Legris, the right partner to accompany you in product development.

aerospace
climate control
electromechanical
filtration
fluid & gas handling
hydraulics
pneumatics
process control
sealing & shielding



ENGINEERING YOUR SUCCESS.

www.parkerlegris.com

Index

Part Number	Page	0185	8-42	0631..01	7-17	0921	9-11	1802	5-36	3102	1-17
		0186	8-42	0631..02	7-18	0922	9-11	1804	5-36	3103	1-14
0101	5-10, 11	0187	8-42	0631..03	7-17	0923	9-12	1805	5-34	3104	1-18, 4-39
0101..39	5-10	0189	8-42	0631..04	7-18	0924	9-13	1806	5-36	3106	1-17
0102	5-16	0191	9-16	0631..05	7-18	0927	9-13	1809	5-35	3107	1-19
0103	5-13	0192	9-16	0631..06	7-19	0928	9-13	1810	5-39	3108	1-14
0104	5-17	0195	8-44	0631..07	7-18	0929	9-10	1814	5-34	3109	1-10, 11
0105	5-9	0196	8-44	0631..08	7-19	0931	9-17	1816	5-36	3110	1-37, 60
0106	5-15	0199	5-12	0631..09	7-17	0932	9-13	1817	9-18	3112	1-16
0107	5-17	0200	9-26	0631..23	7-17	1005T	3-29	1820	5-35	3113	1-13
0108	5-13	0201	9-27	0651	7-8	1010P..M	3-33	1821	9-20, 21	3114	1-9
0109	5-12	0202	9-27	0652	7-8	1010T..A	3-31	1822	5-39	3116	1-20
0110	5-22	0205	9-26	0653	7-7	1010T..P	3-31	1823	9-21	3118	1-27
0110..40	5-22	0205	9-26	0654	7-7	1015Y..F	3-27	1824	5-39	3119	1-27
0110..60	5-22	0206	9-29	0655	7-8	1025L	3-12	1827	3-47, 5-39, 9-33	3120	1-24
0110..70	5-22	0209	9-26	0656	7-9	1025P..R	3-15	1843	9-18	3121	1-9
0111	5-21	0210	9-29	0657	7-9	1025P	3-11	1844	9-18	3122	1-25
0112	5-28	0216	9-29	0658	7-9	1025P..V	3-17	1845	9-18	3124	1-27
0113	5-16	0220	5-27, 9-26	0659	7-7	1025T	3-29	1855	9-19	3126	1-25
0114	5-11	0220..39	5-27	0669	4-59	1025U..A	3-23	1861	9-20	3129	1-12
0116	5-16	0222	1-37	0670	4-63	1025U..K	3-25	1862	9-19	3130	1-37, 60, 6-35
0117	9-8	0285	9-30	0671	4-64	1025U..R	3-20	1863	9-20	3131	1-10
0118	5-14	0400	6-10	0672	4-64	1025U	3-19	1864	9-19	3132	1-16
0118..39	5-14	0401	6-10	0673	4-63	1025U..V	3-25	1866	5-39	3133	1-13
0119	5-15	0402	6-10	0674	4-63	1025V	3-43	1867	9-19	3136	1-20
0119..39	5-16	0411	6-10	0675	4-63	1025V..C	3-43	1870	9-19	3139	1-20
0120	5-28	0414	6-10	0676	4-63	1025Y	3-27	1871	9-18	3140	1-18
0121	9-9	0432	6-15	0677	4-64	1030Y..F	3-27	1872	9-20	3142	1-23
0122	5-26	0436	6-15	0681	8-53	1040H	3-45	1873	9-20	3143	1-23
0123	9-10	0437	6-15	0682	4-64	1050P..M	3-33	2003U..R	3-20	3144	1-21
0124	5-21	0438	6-15	0683	4-64	1050T..A	3-31	2003U	3-19	3146	1-20
0124..40	5-21	0439	6-15	0690 01	7-10	1050T..P	3-31	2005P..R	3-15	3148	1-15
0125	5-27	0446	6-11	0690 02	7-10	1050V	3-43	2005P	3-11	3149	1-27
0126	5-27	0448	6-12	0690 03	7-10	1050V..C	3-43	2005U..R	3-20	3150	8-41
0127	3-47, 5-30, 9-33	0449	6-13	0690 04	7-10	1075Y..F	3-27	2005U	3-19	3151	1-25
0128..39	5-29	0452	6-12	0690 05	7-10	1080H	3-45	2010P..R	3-15	3158	1-15
0132	5-25	0461	6-14	0690 06	7-11	1096Y..F	3-27	2010P	3-11	3159	1-35
0133..39	5-25	0462	6-14	0690 06 01	7-11	1098Y..F	3-27	2010U..R	3-20	3160	1-35
0134	5-25	0465	6-29	0690 07	7-11	1099Y..F	3-27	2010U	3-19	3166	1-24
0135	9-22	0469	6-13	0690 08	7-11	1100H	3-45	2203	8-45	3168	1-24
0136	9-10	0471	6-11	0690 09	7-11	1100P..R	3-15	2270	8-45	3169	1-13
0137	9-31	0472	6-11	0690 10	7-12	1100P	3-11	2272 Midi Series	8-43	3175	1-7, 8
0138	1-92, 9-31	0482	6-12	0690 11	7-12	1100P..V	3-17	2272 Maxi Series	8-46	3180	1-22
0139	9-32	0483	6-12	0691	8-53	1100T..P	3-31	2292	8-45	3181	1-8
0142	5-17	0489	6-13	0694	3-39, 46	1100U..A	3-23	2293	8-44	3182	1-22
0143	9-07	0490	6-17	0695	3-39, 46	1100U..K	3-25	2294 Midi Series	8-43	3183	1-23
0144	9-07	0491	6-17	0697	3-47	1100U ..R	3-20	2294 Maxi Series	8-46	3184	1-22
0145	9-07	0491..64	6-17	0900	9-15	1100U	3-19	2295 Midi Series	8-44	3188	1-23
0151..39	5-29	0492	6-17	0901	9-16	1100U..V	3-25	2295 Maxi Series	8-46	3189	1-35
0152	9-7	0492..64	6-17	0902	9-16	1100Y	3-27	2296	8-44	3192	1-12
0155	9-8	0494	6-18	0903	9-14	1420U	3-33	2297 Midi Series	8-43	3193	1-15
0158	9-7	0496	6-18	0904	9-14	1441U..R	3-38	2297 Maxi Series	8-46	3198	1-14
0163	9-9	0497	6-18	0905	9-14	1442U..E	3-41	2299	7-15, 8-45	3199	1-11
0164	8-53, 9-8	0501	6-39	0906	9-15	1442U..R	3-38	2398	8-45	3202	1-43
0165	5-26	0502	6-39	0907	9-15	1445U..E	3-41	2511	8-43	3204	1-43
0166	5-20	0510	6-39	0908	9-14	1445U..R	3-38	3000 70 00	1-37, 75, 87	3206	1-43
0167	8-53, 9-8	0531	6-39	0909	9-14	1447U..E	3-41	3000 71 00	3-46	3218	1-42
0168	9-8	0532	6-39	0910	9-12	1447U..R	3-38	3000 71 11	3-46	3226	1-43
0168..39	5-29	0562	6-40	0911	9-12	1460U	3-37	3018	1-27	3229	1-41
0169	9-9	0563	6-40	0912	9-11	1461U	3-37	3081	2-9	3266	1-43
0171	8-40	0591	6-41	0913	9-11	1462U	3-37	3082	2-8	3281	1-41
0172	8-42, 43	0602	9-32	0914	9-11	1470P	3-35	3086	2-8	3293	1-41
0178	1-37	0605	1-60, 75, 87, 9-32	0915	9-12	1470U	3-37	3088	2-9	3298	1-41
0180	8-41	0622	7-15	0916	9-12	1471P	3-35	3089	2-8	3299	1-41
0181	8-40	0623	7-15	0917	9-13	1471U	3-37	3091	1-35	3300	1-31
0183	8-40	0627	6-40	0919	9-28	1472P	3-35	3100	1-16, 2-8	3301	9-24
0184	8-40	0630	6-40	0920	9-15	1472U	3-37	3101	1-8	3302	9-24

Index

3303	9-25	3893/3993	1-83	7000	4-16, 55, 6-33	7899	4-61	9094A	8-17	9414A	8-15
3304	1-21	3898/3998	1-84	7010	4-10	7910	6-33	9094E	8-14	9414E	8-13
3306	1-21	3899/3999	1-81	7011	4-10	7911	6-33	9094U	8-12	9414U	8-10
3310	1-21, 9-23	4020	6-35	7012	4-10	7913	6-33	9095 Series 20	8-37	9416A	8-16
3311	9-23	4021	6-35	7020	4-17	7914	6-33	9095 Series 21	8-39	9416E	8-13
3312	9-23	4022	6-35	7030	4-18	7921	4-57	9101 Series 23/24/30	8-25	9416U	8-11
3313	9-23	4023	6-35	7031	4-18	7926	4-57	9101 Series 26	8-27	9421A	8-15
3320	1-31	4202..20	6-48	7040	4-14	7930	4-43	9101 Series 14	8-30	9421E	8-13
3321	1-31	4202..30	6-48	7041	4-14	7931	4-43	9101 Series 18	8-32	9421U	8-10
3329	1-31	4212..20	6-48	7045	4-14	7932	4-43	9105 Series 22	8-30	9440A	8-16
3379	1-32	4212..30	6-48	7060	4-11	7960	4-57	9105 Series 13	8-33	9440E	8-14
3381	1-32	4222..20	6-48	7061	4-11	7961	4-57	9105 Series 17	8-34	9440U	8-11
3391	1-35	4222..30	6-49	7062	4-12	7970	4-61	9105 Series 19	8-35	BPLM	5-46
3524	1-29	4298	6-49	7065	4-11	7971	4-61	9114 Series 23/24/30	8-25	BVG4-LOCK	6-24
3527	1-29	4299	6-49	7066	4-11	7984	4-41	9114 Series 26	8-27	BVG4-L	6-21
3528	1-29	4402	6-31	7067	4-12	7985	4-41	9114 Series 14/22	8-30	BVG4P-LOCK	6-24
3529	1-29	4602	6-43	7100	4-20	7992	4-45	9114 Series 18	8-32	BVGT4-C	6-23
3538	1-28	4810	6-29	7101	4-20	7994	4-41	9114 Series 13	8-33	BVGT4-L	6-21
3539	1-28	4812	6-29	7110	4-20	7995	4-41	9114 Series 17	8-34	C3BPL	5-44
3549	1-28	4832	6-29	7111	4-21	7996	4-41	9114 Series 19	8-35	C4BPL	5-44
3600	1-68, 2-13	4890	4-47	7130	4-19	9020	8-51	9123 Series 23/24/30	8-25	C8BPL	5-44
3601	1-67	4891	4-47	7140	4-19	9040	8-51	9123 Series 14/22	8-30	CBPL	5-44
3602	1-72	4892	4-47	7160	4-19	9071U	8-53	9123 Series 18	8-32	CLIP	1-37, 3-47
3603	1-70	4895	4-47	7170	4-21	9075	8-51	9123 Series 13	8-33	COR4BPL	5-45
3604	1-72	4902	6-23	7180	4-20	9080A	8-17	9123 Series 17	8-34	F3BPL	5-43
3606	1-72	4991	6-23	7190	4-21	9080E	8-14	9123 Series 19	8-35	F4BPL	5-43
3608	1-70	4992	6-23	7300	4-53	9080U	8-12	9201 Series 25/27	8-27	F8BPL	5-43
3609	1-69	6000 71 00	3-17, 25, 46	7316	4-55	9084 Series 14/22	8-31	9201 Series 20	8-36	FBPL	5-43
3610	1-75	6101	1-91	7318	4-55	9084 Series 13	8-33	9201 Series 21	8-38	HBPL	5-46
3614	1-68	6104	1-92	7416	4-55	9084 Series 17	8-34	9201 Series X25/27	8-48	JBPL	5-46
3616	1-73	6105	1-91	7471	4-55	9084 Series 19	8-35	9201 Series X20	8-48	R3BPL	5-45
3618	1-71	6106	1-92	7630	4-18	9084A	8-16	9201 Series X21	8-49	RBPL	5-45
3620	1-74	6114	1-91	7631	4-18	9085 Series 23/24/30	8-26	9214 Series 25/27	8-27	S3BPL	5-45
3621	1-68	6179	1-91	7640	4-15	9085 Series 25/26/27	8-28	9214 Series 20	8-36	SBPL	5-45
3622	1-74	6300	1-50, 2-10	7645	4-15	9085 Series 14/22	8-31	9214 Series 21	8-38	TL	2-13
3626	1-75	6302	1-54	7649	4-15	9085 Series 18	8-32	9214 Series X25/27	8-47	TLT	2-13
3629	1-69	6304	1-55	7660	4-13	9085 Series 13	8-33	9214 Series X20	8-48	WBPL	5-46
3631	1-68	6306	1-54	7662	4-14	9085 Series 17	8-34	9214 Series X21	8-49		
3636	1-73	6307	1-56	7665	4-13	9085 Series 19	8-35	9223 Series 25/27	8-27		
3639	1-73	6315	1-48, 49	7668	4-13	9085 Series 20	8-37	9223 Series 21	8-38		
3666	1-74	6316	1-56	7669	4-13	9085 Series 21	8-39	9226 Series 20	8-36		
3667	1-74	6322	1-59	7680	4-20	9086 Series 23/24/30	8-26	9226 Series 21	8-38		
3668	1-74	6325	1-49	7762	4-21	9086 Series 25/26/27	8-28	9285 Series 25/27	8-29		
3669	1-70	6326	1-58, 59	7770	4-16	9086 Series 14/22	8-31	9285 Series 20	8-37		
3675	1-67	6331	1-63	7771	4-16	9086 Series 18	8-32	9285 Series 21	8-39		
3681	1-67	6332	1-63	7772	4-16	9086 Series 13	8-33	9286 Series 25/27	8-29		
3693	1-71	6333	1-63	7776	4-16	9086 Series 17	8-34	9286 Series 20	8-37		
3699	1-69	6336	1-63	7800	4-59	9086 Series 19	8-35	9286 Series 21	8-39		
3800/3900	1-81, 87, 2-13	6340	1-55	7801	4-59	9086 Series 20	8-37	9286 Series X25/27	8-47		
3800..70	1-87	6351	1-59	7802	4-59	9086 Series 21	8-39	9286 Series X20	8-48		
3801/3901	1-79	6352	1-49	7810	4-23	9086 Series X25/27	8-47	9286 Series X21	8-49		
3802/3902	1-85	6353	1-49	7812	4-23	9086 Series X20	8-48	9287 Series 25/27	8-28		
3803/3903	1-83	6355	1-53	7818	4-51	9086 Series X21	8-49	9287 Series 20	8-36		
3804/3904	1-85, 86	6366	1-58	7820	4-23	9086A	8-16	9287 Series 21	8-38		
3805/3905	1-79	6368	1-58	7822	4-23	9086E	8-14	9287 Series X25/27	8-47		
3806/3906	1-85	6380	1-57	7828	4-51	9086U	8-11	9287 Series X20	8-48		
3808/3908	1-83, 84	6382	1-57	7860	4-49	9087 Series 23/24/30	8-26	9287 Series X21	8-49		
3809/3909	1-81	6383	1-57	7861	4-49	9087 Series 25/26/27	8-28	9293 Series 23/24	8-26		
3816/3916	1-86	6388	1-57, 58	7870	4-49	9087 Series 18	8-32	9293 Series 25/27	8-29		
3821	1-80	6401	6-11	7871	4-49	9087 Series 20	8-36	9401A	8-15		
3821/3921	1-80	6402	6-11	7880	4-37	9087 Series 21	8-38	9401E	8-13		
3826	1-87	6503	1-53	7881	4-37	9087 Series X25/27	8-47	9401U	8-10		
3831/3931	1-80	6505	1-48	7883	4-37	9087 Series X20	8-48	9405A	8-15		
3866/3966	1-87	6508	1-52, 53	7885	4-37	9087 Series X21	8-49	9405U	8-10		
3879/3979	1-82	6509	1-51, 52	7886	4-37	9087A	8-16	9410A	8-15		
3889	1-82	6521	1-50	7892	4-39	9087E	8-14	9410E	8-13		
3889/3989	1-82	6579	1-51	7894	4-39	9087U	8-11	9410U	8-10		

Parker Safety Guide

Selection and Use of Fittings, Function Fittings, Tubing and Related Products

WARNING: Failure or improper selection or improper use of fittings, function fittings, tubing or related products ("Products") can cause death, personal injury and property damage.

Possible consequences of failure or improper selection or improper use of these Products include but are not limited to:

- Fittings thrown off at high speed.
- High velocity fluid discharge.
- Explosion or burning of the conveyed fluid.
- Electrocutation from high voltage electric power lines.
- Contact with suddenly moving or falling objects that are controlled by the conveyed fluid.
- Injections by high pressure fluid discharge.
- Dangerously whipping tubing.
- Contact with conveyed fluids that may be hot, cold, toxic or otherwise injurious.
- Sparking or explosion caused by static electricity build-up or other sources of electricity.
- Sparking or explosion while spraying paint or flammable liquids.
- Injuries resulting from inhalation, ingestion or exposure to fluids.
- Dynamic applications with strong oscillation

Parker Legris has a continuous product development policy and therefore reserves the right to modify products shown in this catalogue. Please treat all dimensions therefore as indicative.

Photography Credits:

Jochen Detscher

Introduction (pages 1, 2, 4, 5, 6, 7, 8, 17), chapter headings and pages 1-33, 2-11, 3-13, 3-21, 6-19

All other photography is the property of Parker Legris.

Graphic Design:

Sylvain Fromentin

Printing:

Zalsman BV



PARKER LEGRIS Industrial Connector Systems

Products are available from:

MARYLAND METRICS

P.O. Box 261 Owings Mills, MD 21117 USA email: sales@mdmetric.com

ph: (410)358-3130 (800)638-1830 fx: (410)358-3142 (800)872-9329

web: http://mdmetric.com RFQ form: http://mdmetric.com/rfq.htm

How to order: Please preface each PARKER LEGRIS Catalog part number with 'R053-' Example: R053-3175 04 10

Parker's Motion & Control Technologies

At Parker, we're guided by a relentless drive to help our customers become more productive and achieve higher levels of profitability by engineering the best systems for their requirements. It means looking at customer applications from many angles to find new ways to create value. Whatever the motion and control technology need, Parker has the experience, breadth of product and global reach to consistently deliver. No company knows more about motion and control technology than Parker. For further Parker Legris information, call Maryland Metrics.



AEROSPACE

Key Markets

- Aircraft engines
- Business & general aviation
- Commercial transports
- Land-based weapons systems
- Military aircraft
- Missiles & launch vehicles
- Regional transports
- Unmanned aerial vehicles

Key Products

- Flight control systems & components
- Fluid conveyance systems
- Fluid metering delivery & atomization devices
- Fuel systems & components
- Hydraulic systems & components
- Inert nitrogen generating systems
- Pneumatic systems & components
- Wheels & brakes



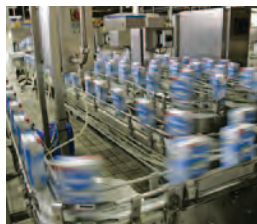
CLIMATE CONTROL

Key Markets

- Agriculture
- Air conditioning
- Food, beverage & dairy
- Life sciences & medical
- Precision cooling
- Processing
- Transportation

Key Products

- CO₂ controls
- Electronic controllers
- Filter driers
- Hand shut-off valves
- Hose & fittings
- Pressure regulating valves
- Refrigerant distributors
- Safety relief valves
- Solenoid valves
- Thermostatic expansion valves



ELECTROMECHANICAL

Key Markets

- Aerospace
- Factory automation
- Food & beverage
- Life science & medical
- Machine tools
- Packaging machinery
- Paper machinery
- Plastics machinery & converting
- Primary metals
- Semiconductor & electronics
- Textile
- Wire & cable

Key Products

- AC/DC drives & systems
- Electric actuators
- Controllers
- Gantry robots
- Gearheads
- Human machine interfaces
- Industrial PCs
- Inverters
- Linear motors, slides and stages
- Precision stages
- Stepper motors
- Servo motors, drives & controls
- Structural extrusions



FILTRATION

Key Markets

- Food & beverage
- Industrial machinery
- Life sciences
- Marine
- Mobile equipment
- Oil & gas
- Power generation
- Process
- Transportation

Key Products

- Analytical gas generators
- Compressed air & gas filters
- Condition monitoring
- Engine air, fuel & oil filtration & systems
- Hydraulic, lubrication & coolant filters
- Process, chemical, water & microfiltration filters
- Nitrogen, hydrogen & zero air generators



FLUID & GAS HANDLING

Key Markets

- Aerospace
- Agriculture
- Bulk chemical handling
- Construction machinery
- Food & beverage
- Fuel & gas delivery
- Industrial machinery
- Mobile
- Oil & gas
- Transportation
- Welding

Key Products

- Brass fittings & valves
- Diagnostic equipment
- Fluid conveyance systems
- Industrial hose
- PTFE & PFA hose, tubing & plastic fittings
- Rubber & thermoplastic hose & couplings
- Tube fittings & adapters
- Quick disconnects



HYDRAULICS

Key Markets

- Aerospace
- Aerial lift
- Agriculture
- Construction machinery
- Forestry
- Industrial machinery
- Mining
- Oil & gas
- Power generation & energy
- Truck hydraulics

Key Products

- Diagnostic equipment
- Hydraulic cylinders & accumulators
- Hydraulic motors & pumps
- Hydraulic systems
- Hydraulic valves & controls
- Power take-offs
- Rubber & thermoplastic hose & couplings
- Tube fittings & adapters
- Quick disconnects



PNEUMATICS

Key Markets

- Aerospace
- Conveyor & material handling
- Factory automation
- Food & beverage
- Life science & medical
- Machine tools
- Packaging machinery
- Transportation & automotive

Key Products

- Air preparation
- Compact cylinders
- Field bus valve systems
- Grippers
- Guided cylinders
- Manifolds
- Miniature fluidics
- Pneumatic accessories
- Pneumatic actuators & grippers
- Pneumatic valves and controls
- Rodless cylinders
- Rotary actuators
- Tie rod cylinders
- Vacuum generators, cups & sensors



PROCESS CONTROL

Key Markets

- Chemical & refining
- Food, beverage & dairy
- Medical & dental
- Microelectronics
- Oil & gas
- Power generation

Key Products

- Analytical sample conditioning products & systems
- Fluoropolymer chemical delivery fittings, valves & pumps
- High purity gas delivery fittings, valves & regulators
- Instrumentation fittings, valves & regulators
- Medium pressure fittings & valves
- Process control manifolds



SEALING & SHIELDING

Key Markets

- Aerospace
- Chemical processing
- Consumer
- Energy, oil & gas
- Fluid power
- General industrial
- Information technology
- Life sciences
- Military
- Semiconductor
- Telecommunications
- Transportation

Key Products

- Dynamic seals
- Elastomeric o-rings
- EMI shielding
- Extruded & precision-cut, fabricated elastomeric seals
- Homogeneous & inserted elastomeric shapes
- High temperature metal seals
- Metal & plastic retained composite seals
- Thermal management

PARKER LEGRIS Industrial Connector Systems

Products are available from:

MARYLAND METRICS

P.O. Box 261 Owings Mills, MD 21117 USA email: sales@mdmetric.com

ph: (410)358-3130 (800)638-1830 fx: (410)358-3142 (800)872-9329

web: <http://mdmetric.com> RFQ form: <http://mdmetric.com/rfq.htm>

How to order: Please preface each PARKER LEGRIS Catalog part number with 'R053-' Example: R053-3175 04 10



ENGINEERING YOUR SUCCESS.